

APPROVAL SHEET

CUSTOMER	Schukat
CUSTOMER P/N	
DESCRIPTION	24V/3.75A
EDAC MPN	EA10931F(T01)
EDAC MODEL NO FOR SAFETY	EA10931F-240
DATE	2025-06-25
REVISION	3

APPROVED	DESIGN	PREPARE	RoHS
陳瑰琦	許齊順	許齊順	
CONCLUSION 判定結果	APPROVED 承認	CONDITON APP'D 有條件承認	CUSTOMER'S SIGNATURE: 客戶簽章:



翌勝電子股份有限公司
EDAC POWER ELECTRONICS CO., LTD.
 新北市中和區建一路 150 號 11 樓之 2(E 棟)
 TEL:886-2-82263289 FAX:886-2-82263327
翌勝電子(蘇州)有限公司
 Edac Power Electronics (Suzhou) Co., Ltd.
 江蘇省蘇州工業園區勝浦鎮常勝路 59 號
 No.59, Chang Sheng Road, Sheng Pu,
 Suzhou Industrial Park, Jiangsu, China
 Tel: 512-6282-1628 Fax: 512-6282-9608
東莞市翌勝電子有限公司
 廣東省東莞市鳳崗鎮鳳崗科技路6號3樓901室
 Tel: 0769-38859898 Fax: 0769-38859897

Index

1-0 General Description

2-0. Input Requirements Specification

3-0. Output Requirements Specification

4-0. Reliability Specification

5-0. Environment Specification

6-0. Safety Specification

7-0. Mechanical Specification

1-0. General Description

The purpose of the document is to specify a **Single phase AC input, single output** switching power supply. This specification is suitable for: EA10931F

This product is AC to DC switching power transfer device, it can provide for a 24Vdc, 3.75A max., 90W Max. DC output with constant voltage source.

This Specification defines the input, output, performance characteristics, environment, noise and safety requirement for a power supply.

2-0. Input Requirements

2-1. AC Input Voltage

Maximum Voltage : 264Vac

Normal Voltage : 100~240Vac

Minimum Voltage : 90Vac

2-2. AC Input Frequency

Maximum Frequency : 63Hz

Normal Frequency : 50~60Hz

Minimum Frequency : 47Hz

2-3. Input Current:

1.5A (Max.) @ 100Vac/60Hz-240Vac/50Hz will Max. load.

2-4. Efficiency:

Designed to meet the following standard :

2-4-1. Efficiency :

89% (Avg.) at 115Vac/60Hz & 230Vac/50Hz input voltage and 25%、 50%、 75% & 100% of Max. output current.

79% at 115Vac/60Hz & 230Vac/50Hz input voltage and 10% of Max. output Current.

2-4-2.No Load Power Consumption : No Load Watt < 0.15W at normal line input.

2-5. Configuration

3-wire AC input (**Line ,Neutral ,FG**)

2-6. Input Fuse

The hot line side of the input shall have a fuse, rating (**T3.15A/250V**)

2-7. Inrush Current:

60A at 110Vac At cold start, Max. load.

120A at Vac At cold start, Max. load.

2-8. Line Regulation:

This line regulation is less than $\pm 1\%$, 100Vac/60Hz-240Vac/50Hz, with Max. load.

2-9. Hold Up Time:

10mSec. @ 100Vac/60Hz-240Vac/50Hz, with Max. load.

2-10. Rise Time:

50mSec. @ 100Vac/60Hz-240Vac/50Hz, with Max. load.

From 10% to 90% of output voltage.

2-11. Turn-ON Time:

The output voltage should rise to 90% of rated output voltage.

in less than **3 SEC.** 100Vac/60Hz-240Vac/50Hz, with Max. load.

2-12. Harmonic Standard and Power Factor

The adaptor complied with IEC61000-3-2 Class D harmonic standard while input power over than 75W. The PF shall > 0.95 @ 100Vac input and > 0.9 @ 240Vac input with Max. load.

3-0. Output Requirements

3-1. Output Voltage and Current

Output Voltage (Vdc)	Current Min. (A)	Current Max. (A)
+24V	0A	3.75A

3-2. Combine Regulation

Output Voltage (Vdc)	Tolerance (%)	Regulation (V)
+ 24V	+5%~-5%	22.8V ~ 25.2V

3-3. Dynamic Load Regulation

$\pm 5\%$ excursion for 50% - 100% or 100% - 50% load change of DC output at any frequency up to 1KHz(duty 50%)

3-4. Ripple & Noise

The power supply shall not exceed the following limits on the indicated voltage for 60Hz or 50Hz ripple,

Switching frequency ripple and noise and dynamic load variations measured with a 20MHz

bandwidth.

Output	Ripple/Noise
+24V	1.5% max. of full load & 50% load current

Ripple / Noise : 60Hz ripple + switching ripple and noise.

Ripple & Noise are measured at the end of output cable which are added a 0.1uF ceramic capacitor and a 47uF electrolytic capacitor.

3-7. Over Voltage Protection

150% Max. of the rated output voltage.

The adaptor shall have OVP with auto-recovery mode when output voltage reaches the trigger point of OVP.

3-8. Short-Circuit Protection

The adapter can withstand continuous short at DC output and no damage. It will enter into Normal condition if the fault condition is removed. The short circuit impedance should be less than 0.3R.

3-9. Over Current Protection

110 ~ 150% of rated output current.

The adapter can withstand continuous short at DC output and no damage.

It will enter into normal condition if the fault condition is removed.

3-10. Stability

2% Max. at constant load with constant input (after 30 minutes of operation).

3-11. Drop-out (Power Line Disturbance)

Output voltage shall remain within the specified regulation range, through the absence of a line input during 1/2 cycle, at full load and normal AC line input.

3-12. Voltage Isolation

The DC ground will be isolated from the AC neutral and AC line.

4-0. Reliability.

4-1. MTBF: (MIL-HDBK-217F)

The power supply shall be designed and produced to have a mean time between failure (MTBF) of 100,000 hours at 25 .

5-0. Environment.

5-1 Temperature :

- a. Operating : 0 to 40
- b. Storage : -20 to 85

5-2 Humidity :

- a. Operating : 10 to 90 %
- b. Storage: 5 to 90 %

5-3 Altitude :

From sea level to 5,000 Meter (operation) and 5,000 Meters (non operation)

6-0. Safety

6-1. Hi-Pot Test

AC 3000V 10mA 60 Sec. between primary and secondary circuit.
AC 1800V 10mA 2 Sec. between L & N and FG.

6-2. Insulation Test

500Vdc 3sec. between primary and secondary circuit.
IR should 50M

6-3. Leakage Current

750uA, at 240Vac/50Hz.

6-4. Safety

UL, CUL, TUV, CB, UKCA, CE, FCC, BSMI, CCC, PSE

6-5. EMS

Items	Specification	Reference
ESD	Contact : $\pm 4KV$	IEC61000-4-2
	Air : $\pm 8KV$	
RS	Frequency : 80 ~ 1000MHz Field Strength 3V/M , 80% AM(1KHz)	IEC61000-4-3
EFT	1.0KV on input AC power ports.	IEC61000-4-4
SURGE	Line to Line : $\pm 1KV$ (peak)	IEC61000-4-5
	Line to FG : $\pm 2KV$ (peak)	

6-6. EMI

Comply with Standards
CISPR32, EN55032 Class B
FCC PART 15 Class B

7-0. Mechanical Characteristics.

7-1. Physical Size: 134.55mm (L) * 58.8mm (W) * 25.4mm (H)

7-2. Enclosure material: 94V-0 minimum.

7-3. Output Cable (Reference) : UL1185 # 18

7-4. Vibration Test

The vibration frequencies are set at 20Hz, with total amplitude of 1.5mm along the 3 directions namely X-Y-Z. The each direction should be vibrated for 60 minutes, after testing no abnormal electrical or mechanical should occur.

7-5. Drop Test (Referencing to CSA C22.2 No.950/UL1950/UL1310/EN62368)

Products shall be dropped from a height of 1000 mm onto a horizontal surface consists of hardwood at 13mm thick, mounted on two layers of plywood each 19mm to 20mm thick, all supported on a concrete or equivalent non-resilient floor. Upon conclusion of test , the equipment don't need be operational , but need meet Hi-Pot specification requirement .

7-6. Net Weight (Reference) : 350g

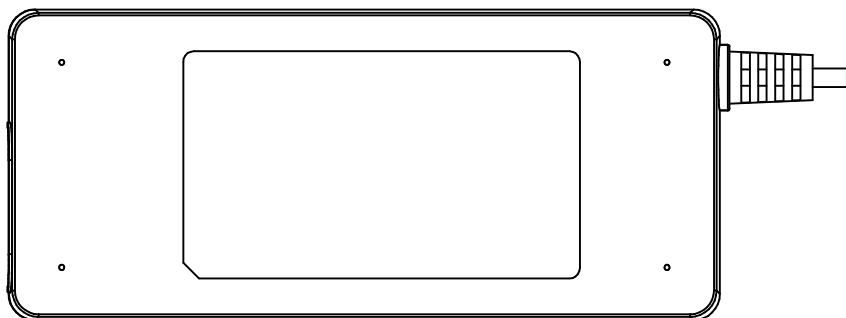
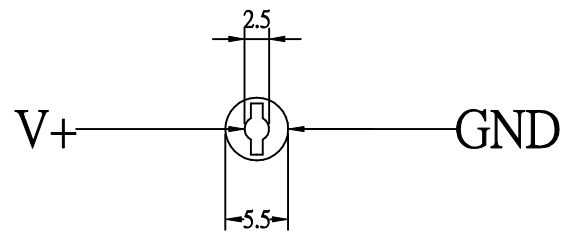
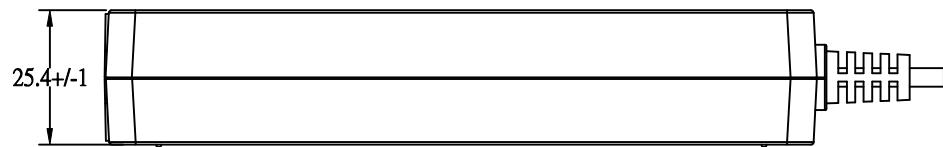
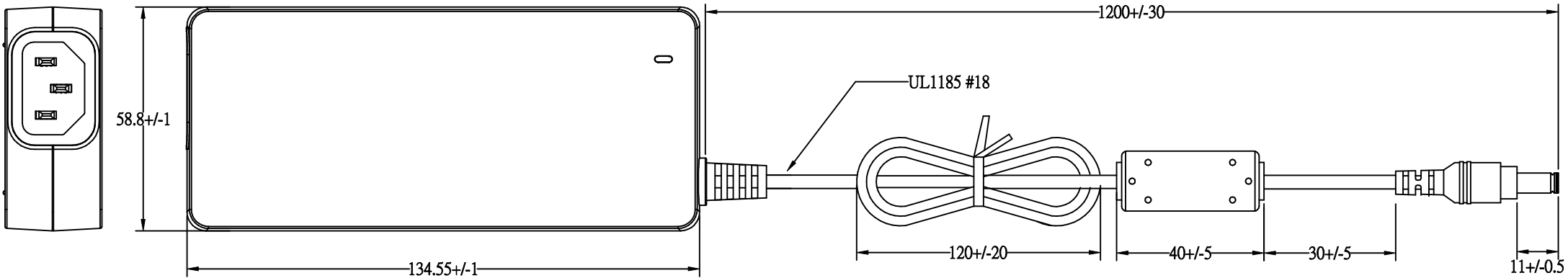

EDAC POWER ELEC.				APPROVED
MODEL	EA10931F(T01)	UNIT	mm	DESIGNED
color	BLACK	SCALE		CHECK
cus.		DATE	2025-06-25	DRAWING L.J.YU

EDAC EDACPOWER ELEC.

AC ADAPTER 电源适配器 电源供应器

MODEL 型号 型号 :EA10931F-240

AC INPUT 输入 输入 :100-240Vac, 2.5A, 50-60Hz

DC OUTPUT 输出 输出 :24.0V==3.75A 90.0W



CAUTION 注意 注意

FOR INDOOR USE ONLY 室内产品 室内产品使用

I.T.E. USE ONLY

S/N:YYWWXXXXX

2312810930016 C1 C3

MADE IN CHINA 中国制造 中国製造



I.T.E. POWER SUPPLY
41TJ
E209833 LPS



SGS-250169-EA



R33147
RoHS



制造商:翌胜电子股份有限公司



EDACPOWER 11-2FL., No. 150, Jian Yi Rd., Chung Ho District, New Taipei City, Taiwan, R.O.C.

74.3

3

EDAC P/N.: 312810930016

Background: Black color

Character: Silver color

Unit: mm

105mm

Bedienungsanleitung für EDAC Tisch- und Steckernetzteile



Bestimmungsgemäßer Gebrauch

- Dieses Netzteil ist für die Versorgung von Niederspannungsverbrauchern entwickelt worden und erfüllt die Anforderungen der RoHS (2011/65/EG, 215/863/EG), Niederspannungsrichtlinie (2014/35/EU) und der EMV-Richtlinie (2014/30/EU).

Sicherheits-Hinweise

- Bitte die Bedienungsanleitung vor Inbetriebnahme lesen!
- Vor der Inbetriebnahme sollten Sie die Netzspannung und die am Netzgerät angegebene Eingangsspannung sowie die Spannung und Polarität des Ausgangsstromes und die Leistung des anzuschließenden Gerätes vergleichen. Beides sollte mit den Anforderungen übereinstimmen.
- Im Betrieb ist eine Gehäuseerwärmung normal und unbedenklich. Allerdings sollte es nicht abgedeckt und in der Nähe von Heizkörpern oder unter direkter Sonneneinstrahlung betrieben werden.
- Arbeiten Sie nie mit dem Netzadapter, wenn er offen ist oder einen schadhafte Netzanschluss oder ein beschädigtes (zerrissenes/zerbrochenes) Gehäuse hat. Mögliche Lebensgefahr!
- Überprüfen Sie regelmäßig die mechanische Sicherheit des Geräts z.B. auf Beschädigung des Gehäuses.
- Öffnen Sie niemals das Gerät. Es enthält keine Servicebauteile.
- Reparaturen dürfen nur von einem Techniker ausgeführt werden. Bei eigenmächtigen Änderungen oder Reparaturen am Gerät erlischt die Garantie.
- Vor Spritzwasser und Feuchtigkeit schützen.

Bedienung

- Setzen Sie bei Netzteilen mit wechselbarem Eingangsclip den benötigten Clip für den vorhandenen Netzanschluss ein.
- Prüfen Sie bei Netzteilen mit wechselbaren Ausgangssteckern vor Inbetriebnahme die richtige Auswahl und Polarität je nach Anwendung.
- Die LED Betriebsanzeige leuchtet (sofern vorhanden) auch ohne angeschlossenes Endgerät, sobald das Netzteil mit der Netzspannung verbunden ist.

Pflege

- Zum Reinigen dürfen Sie keinerlei Reinigungsmittel verwenden. Ausschließlich mit einem trockenen Tuch abwischen.

Hinweis

- Wird das Netzteil nicht in industriellen Anwendungen verwendet, sondern einem Endverbraucher mit dem zugehörigen Endgerät zugänglich gemacht, müssen ERP 2019/1782 relevante Daten im Handbuch des Endgerätes aufgeführt werden.

Entsorgung

- Elektronische Altgeräte sind Wertstoffe und gehören nicht in den Hausmüll. Ist das Gerät am Ende seiner Lebensdauer, entsorgen Sie es nach den geltenden gesetzlichen Bestimmungen bei den geeigneten Sammelstellen des Entsorgungssystems. Eine Entsorgung über den Hausmüll ist untersagt.



Hersteller

EDACPOWER Electronics Co., Ltd.
11-2FL., No.150, Jian Yi Rd., Chung Ho
District, New Taipei City, Taiwan, R.O.C.
Internet: www.edac.com.tw
E-Mail: sales@edac.com.tw
Telefon: + 886-2-8226-3289

Importeur

Schukat electronic Vertriebs GmbH
Hans-Georg-Schukat-Straße 2
DE-40789 Monheim am Rhein
Telefon: +49-2173-950-5
Telefax: +49-2173-950-999
E-Mail: info@schukat.com
Internet: www.schukat.com
WEEE-Reg.-Nr.: DE 23942637

Stand: Mai 2020

148mm

EA10931F(T01) 包装示意图

礼盒： 禮盒 禮盒白色 200*100*50mm 29410504

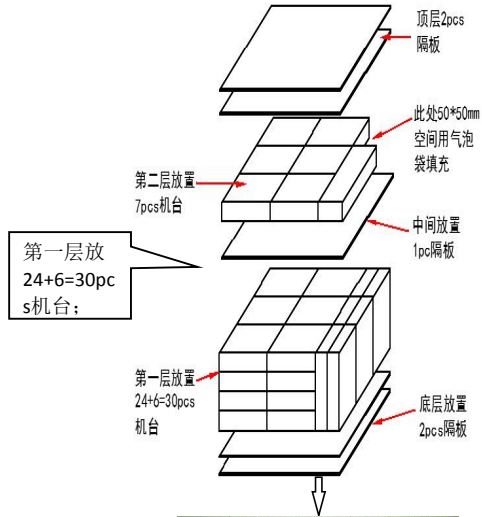
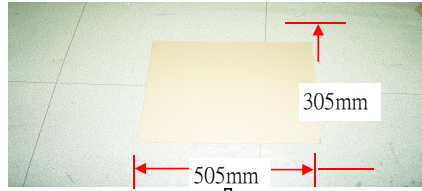
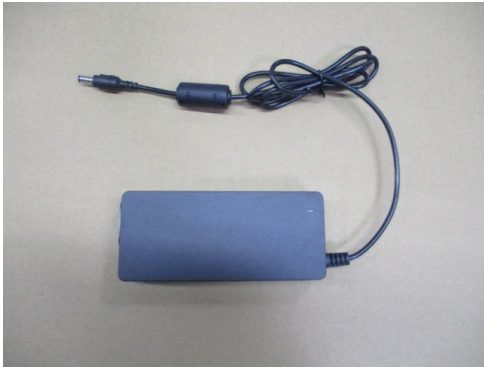

纸箱： CARTON G+ZSG 520*319*300mm (用于欧规栈板) 510104043

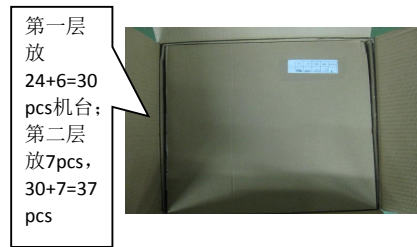
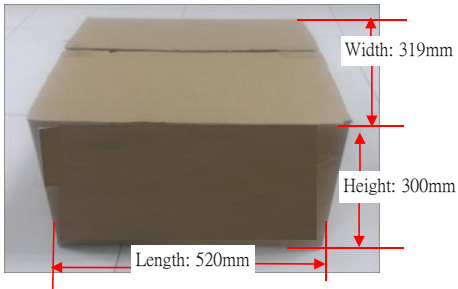

隔板： ISOLATING BOARD 8X8/C楞505*305mm 510301114

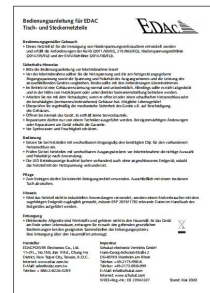

先放说明书于白盒中，在放置机台压住说明书

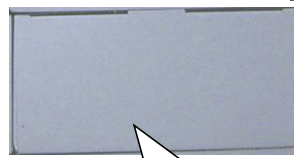

装好后盖上礼盒上盖