



## SPECIFICATIONS

CUSTOMER : SCHUKAT  
MASS PRODUCTION CODE : SMMH043480272G-C28  
SAMPLE VERSION : 01  
SPECIFICATIONS EDITION : 002  
DRAWING NO. (Ver.) : SMMH043480272G-C28-WX-B

**Customer Approved**

Date:

Approved	Checked	Designer
 罗潇	闫伟	洪康凯

- Preliminary specification for design input  
 Specification for sample approval





## Contents

### 1. SPECIFICATIONS

- 1.1 Features
- 1.2 Mechanical Specifications
- 1.3 Absolute Maximum Ratings
- 1.4 DC Electrical Characteristics
- 1.5 Optical Characteristics
- 1.6 Backlight Characteristics
- 1.7 CTP Characteristics
- 1.8 EEPROM Information

### 2. MODULE STRUCTURE

- 2.1 Interface Pin Description
- 2.2 Timing Characteristics

### 3. QUALITY ASSURANCE SYSTEM

- 3.1 Quality Assurance Flow Chart
- 3.2 Inspection Specification

### 4. RELIABILITY TEST

- 4.1 Reliability Test Condition

### 5. PRECAUTION RELATING PRODUCT HANDLING

- 5.1 Safety
- 5.2 Handling
- 5.3 Storage
- 5.4 Terms of Warranty

Appendix: 1. LCM Drawing

Note : For detailed information please refer to IC data sheet :

Primacy(TFT LCD):ST7282A-G6-LS



## 1. SPECIFICATIONS

### 1.1 Features

Item	Standard Value
Display Type	480 (RGB)* 272
LCD Type	Normally Black, Transmissive type
Screen size(inch)	4.3 inch
Viewing Direction	FREE
Color configuration	RGB-Strip
Other(controller/driver IC)	ST7282A-G6-LS
Interface	RGB -24BIT

### 1.2 Mechanical Specifications

#### Module

Item	Standard Value	Unit
Outline Dimension	121.82(W) ×80.64(L) ×4.92(H) mm	mm

#### TFT LCD

Item	Standard Value	Unit
Active Area	95.04(W)×53.86(L)	mm



## 1.3 Absolute Maximum Ratings

### Module

Item	Symbol	Condition	Min.	Max.	Unit
Operating Temperature	T <sub>OP</sub>	-	-30	80	°C
Storage Temperature	T <sub>ST</sub>	-	-30	80	°C

## 1.4 DC Electrical Characteristics

### Module

GND = 0V, Ta = 25°C

Item	Symbol	Condition	Min.	Typ.	Max.	Unit
Power Supply Voltage	VDD	-	3.0	3.3	3.6	V
Input H/L Level Voltage	VIH	-	0.7VDD	-	VDD	V
	VIL	-	GND	-	0.3 VDD	V
Output H/L Level Voltage	VOH	-	VDD-0.4	-	VDD	V
	VOL	-	GND	-	GND+0.04	V
Supply Current	IDD	VDD = 3.3 V	-	20	30	mA



## 1.5 Optical Characteristics

### TFT LCD Module

VDD= 3.3 V, Ta=25°C

Item		Symbol	Condition	Min.	Typ.	Max.	unit	-
Response time	Tr+Tf	25°C	-	-	30	35	ms	-
Viewing angle	Top	θY+	CR ≥ 10	70	80	-	Deg.	Note 4
	Bottom	θY-		70	80	-		
	Left	θX-		70	80	-		
	Right	θX+		70	80	-		
Contrast ratio		CR		800	1000	-	-	Note 3
Color of CIE Coordinate (B/L& LCD&CTP )	White	X	IF=60 mA	-0.05	0.336	+0.05	-	Note1
		Y			0.356			
	Red	X			0.585			
		Y			0.374			
	Green	X			0.364			
		Y			0.571			
	Blue	X			0.141			
		Y			0.097			
Average Brightness Pattern=white display (B/L & LCD &CTP)*1		IV	IF= 60mA	800	1000	-	cd/m2	Note1
Uniformity (B/L & LCD &CTP)*2		△B	-	75	-	-	%	Note1

Note 1:

\*1:  $\Delta B = B(\min) / B(\max) * 100\%$ .

\*2: Measurement Condition for Optical Characteristics:

- a: Environment: 25°C±5°C / 60±20%R.H, no wind, dark room below 10 Lux at typical lamp current and typical operating frequency.
- b: Measurement Distance: 500 ± 50 mm , (θ= 0°)
- c: Equipment: TOPCON BM-7 fast, (field 1°), after 10 minutes operation.
- d: The uncertainty of the C.I.E coordinate measurement ±0.01, Average Brightness ± 4%

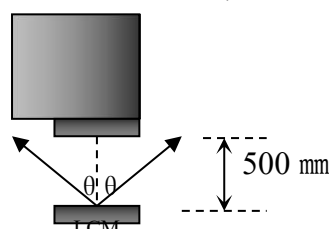
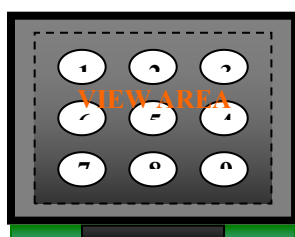

Colorimeter=BM-7



To be measured at the center area of panel with a viewing cone of 1° by Topcon luminance meter BM-7, after 10 minutes operation (module)

Note2: Definition of response time:

The output signals of photo detector are measured when the input signals are changed from “black” to “white”(falling time) and from “white” to “black”(rising time), respectively. The response time is defined as the time interval between the 10% and 90% of Amplitudes.

Refer to figure as below:

Normally White

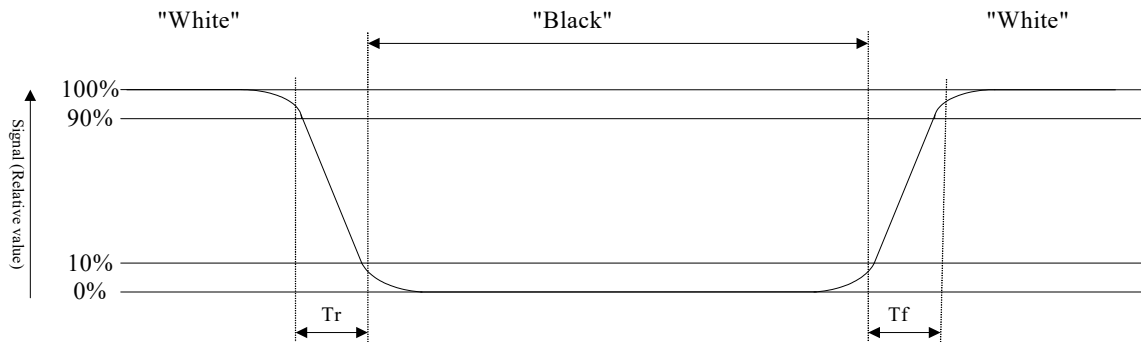

Normally Black

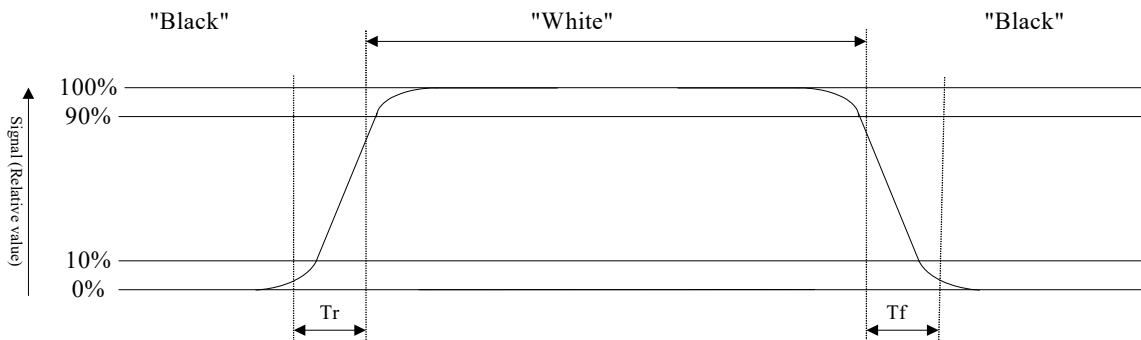

Note3: Definition of contrast ratio:

Contrast ratio is calculated with the following formula

$$\text{Contrast ratio (CR)} = \frac{\text{Photo detector output when LCD is at "White" state}}{\text{Photo detector output when LCD is at "Black" state}}$$

Note4: Definition of viewing angle:

Refer to figure as below:





## 1.6 Backlight Characteristics

### 1.6.1 Backlight LED Driver IC (MP3362) Characteristics

Item	Symbol	Min.	Typ.	Max.	Unit
Led Driver Power Voltage	VLED	3.0	3.3	12	V
Led Driver Power Current	ILED	-	0.4	-	A
PWM Dimming Freq	FDIM	-	-	2	kHZ
EN threshold	EN ON	1.3	-	-	V
	EN OFF	-	-	0.4	V

### 1.6.2 INTERNAL Backlight Electrical / Optical Characteristics

Item	Symbol	Conditions	Min.	Typ.	Max.	Unit
Forward Voltage	VF	IF=60mA	16.2	18	19.8	V
Average Brightness	IV		18000	19000	-	cd/m <sup>2</sup>
CIE Color Coordinate	X		0.29	0.31	0.33	-
	Y		0.28	0.30	0.32	
Led lifetime				50k		Hrs
Color			White			

Circuit Diagram

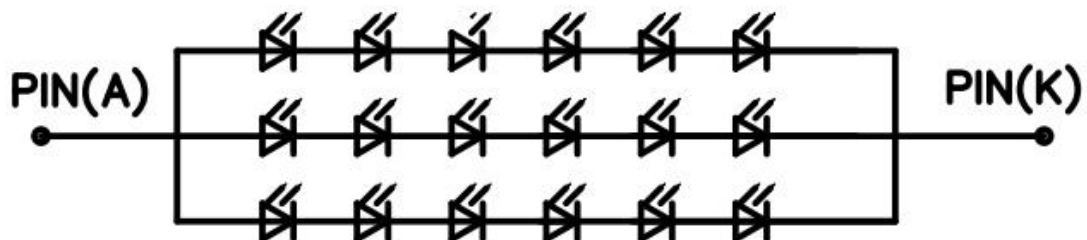



## 1.7 CTP Characteristics

Items.	Specification	Remark
Touch Panel Size	4.3Inch	-
Touch type	True Multi-touch with up to 5 Points of Absolution X and Y coordinates	-
Structure type	G+G	-
Outline Dimension	121.82mm*80.64mm*1.85mm	-
View Area	96.04mm*54.86mm	-
Interface	I <sup>2</sup> C	-
I <sup>2</sup> C Address(8 bit)	0x55	-
Operation Temperature	-30°C~80°C	-
Storage Temperature	-30°C~80°C	-
Transparency	≥86%	-
Control IC	ST1633I	-
Structure	LENS: T=1.1 mm	-



## 1.8 EEPROM Information

### 1.8.1 EEPROM Number :M24C02-RMN6TP

### 1.8.2 EEPROM Device Address 7bit :0X50

### 1.8.3 EEPROM Register Information:

Address	Description	Data	Name/Value(typ.)	Notes
00h	No Data	00h	0	
01h	TFP-Interface	01h	DPI	1: DPI, 2: DSI
02h	CTP-Interface	01h	I2C	0: No CTP, 1: I2C
03h	Manufacturer	53h	S	SMt Smartwin (ASCII)
04h		57h	M	
05h		00h		
06h	Size	04h	4.3 inch	xx.xx inch
07h		03h		
08h	X-Res.(H-Byte)	01h	480 px	
09h	X-Res.(L-Byte)	E0h		
0Ah	Y-Res.(H-Byte)	01h	272px	
0Bh	Y-Res.(L-Byte)	10h		
0Ch	Pixel-Clock(typ.)	09h	9 MHz	xx.xx MHz
0Dh		00h		
0Eh	Color-Depth	18h	24 bit	
0Fh	HBP(H-Byte)	00h	43	
10h	HBP(L-Byte)	2Bh		
11h	HPW	04h	4	
12h	HFP(H-Byte)	00h	8	
13h	HFP(L-Byte)	08h		
14h	VBP(H-Byte)	00h	12	
15h	VBP(L-Byte)	0Ch		
16h	VPW	04h	4	
17h	VFP(H-Byte)	00h	8	
18h	VFP(L-Byte)	08h		
19h	Polarity_Mode	24h	00100100b	Bit0: H_sync_polarity Bit1: V_sync_polarity Bit2: DE_polarity (0: Negative, 1: Positive)  Bit3: H_sync_phase(Reserve) Bit4: V_sync_phase(Reserve) Bit5: DE_phase (0: Rising edge, 1: Falling edge)  Bit6: Pixel_invert  Bit7: DE_mode (0: DE enabled, 1: Combined Sync)
1Ah	Rotation	00h	00000000b	Bit 0: Display Mirror X Bit 1: Display Mirror Y Bit 2: Display Swap X/Y Bit 3: Reserved, 0 Bit 4: Touch Mirror X Bit 5: Touch Mirror Y Bit 6: Touch Swap X/Y Bit 7: Reserved, 0
1Bh	Reserve	00h	0	
1Ch-FFh	No Data	00h	0	



## 2. MODULE STRUCTURE

### 2.1 Interface Pin Description

#### Interface of TFT

Pin No.	Symbol	Function
1	GND	Ground
2	GND	Ground
3	GND	Ground
4	GND	Ground
5	+3V3 BKL	3.3V Power Input for BKL
6	+3V3 BKL	3.3V Power Input for BKL
7	+3V3 BKL	3.3V Power Input for BKL
8	+3V3 BKL	3.3V Power Input for BKL
9	PWM BKL	Back light PWM Control signal
10	+3V3 TFT	3.3V Power Input for TFT
11	GND	Ground
12	R0	Red data signal
13	R1	Red data signal
14	R2	Red data signal
15	R3	Red data signal
16	R4	Red data signal
17	R5	Red data signal
18	R6	Red data signal
19	R7	Red data signal
20	G0	Green data signal
21	G1	Green data signal
22	G2	Green data signal
23	G3	Green data signal
24	G4	Green data signal
25	G5	Green data signal
26	G6	Green data signal



27	G7	Green data signal
28	B0	Blue data signal
29	B1	Blue data signal
30	B2	Blue data signal
31	B3	Blue data signal
32	B4	Blue data signal
33	B5	Blue data signal
34	B6	Blue data signal
35	B7	Blue data signal
36	GND	Ground
37	VSYNC	Vertical Sync input for TTL mode.
38	HSYNC	Horizontal Sync input for TTL mode.
39	DE	Data input enable applied to the RGB.
40	GND	Ground
41	PCLK	Clock signal for data latching and internal.
42	GND	Ground
43	MODE(STDBY)	Standby mode, Normally pull high.
44	TFT-RESET	TFT Reset Pin
45	TP-RST	CTP Reset Pin
46	TP-INT	INT Output
47	TP_SDA/EEPROM-SDA	TP I2C Data/EEPROM I2C Data
48	TP_SCL/EEPROM-SCL	TP I2C Clock/EEPROM I2C Clock
49	+3V3 CTP	3.3V Power Input for CTP
50	GND	Ground



**Recommended matched connector :DF23C-50DP-0.5V**

**Recommended driving boards:**

- ESoPe :SLD\_C\_W\_S3
- ESoPe :SLD\_C\_W\_P4\_C6

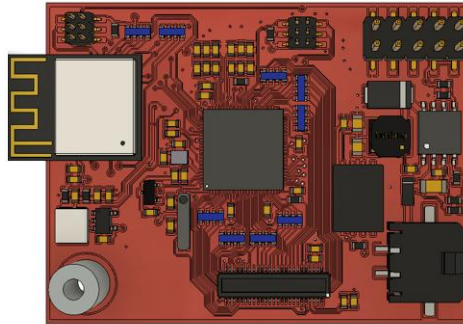
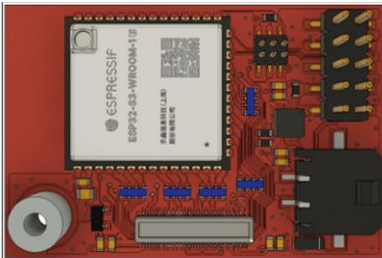



## 2.2 Timing Characteristics

### 2.2.1 Power On Sequence

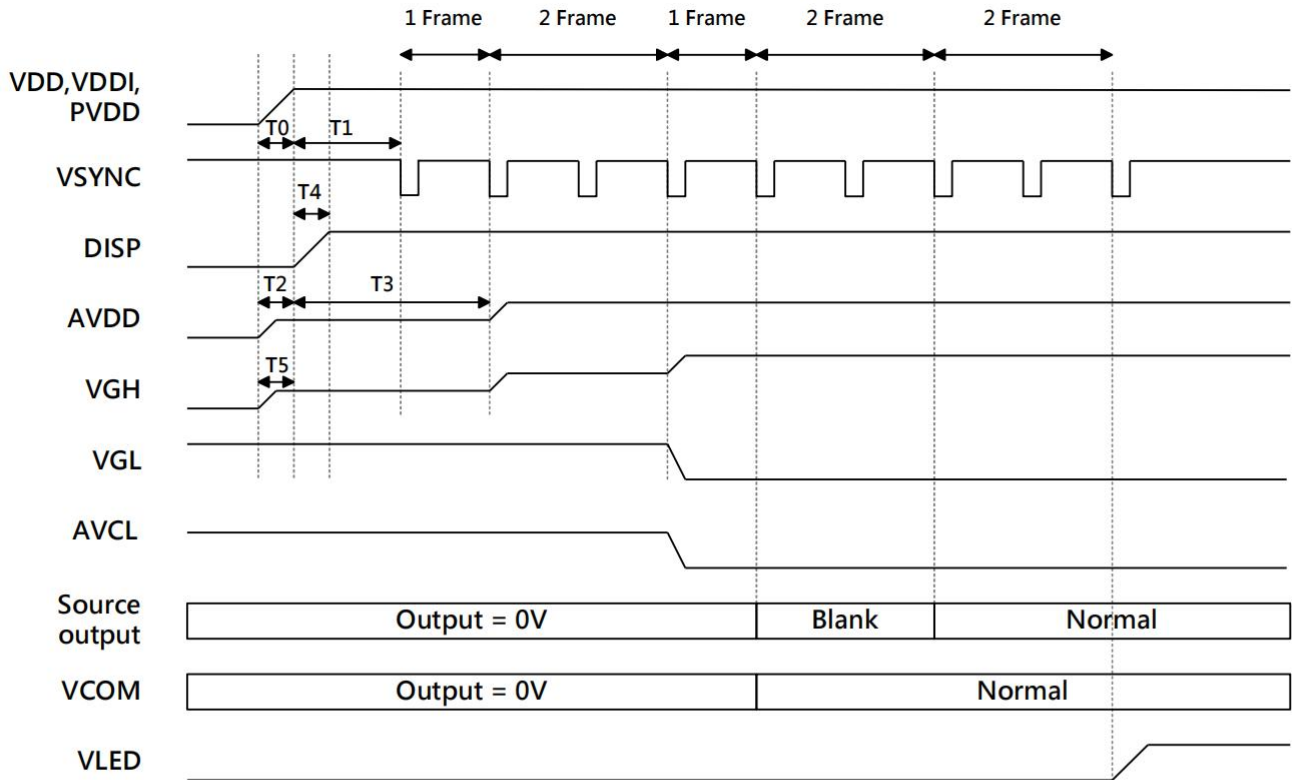

	Description	Min. Time
T0	Determined by the external power	
T1	Time from stable VDD, VDDI, PVDD set-up to the first VSYNC	T1=0
T2	Time from AVDD=0V to AVDD=3.3V	T2=T0
T3	Time from AVDD=3.3V to AVDD=6.0V	T3=T1+ (1*Frame)
T4	Time from stable VDD, VDDI, PVDD set-up to DISP asserted	T4=0
T5	Time from VGH=0V to VGH=3.3V	T5=T0



### 2.2.2 Power Off Sequence

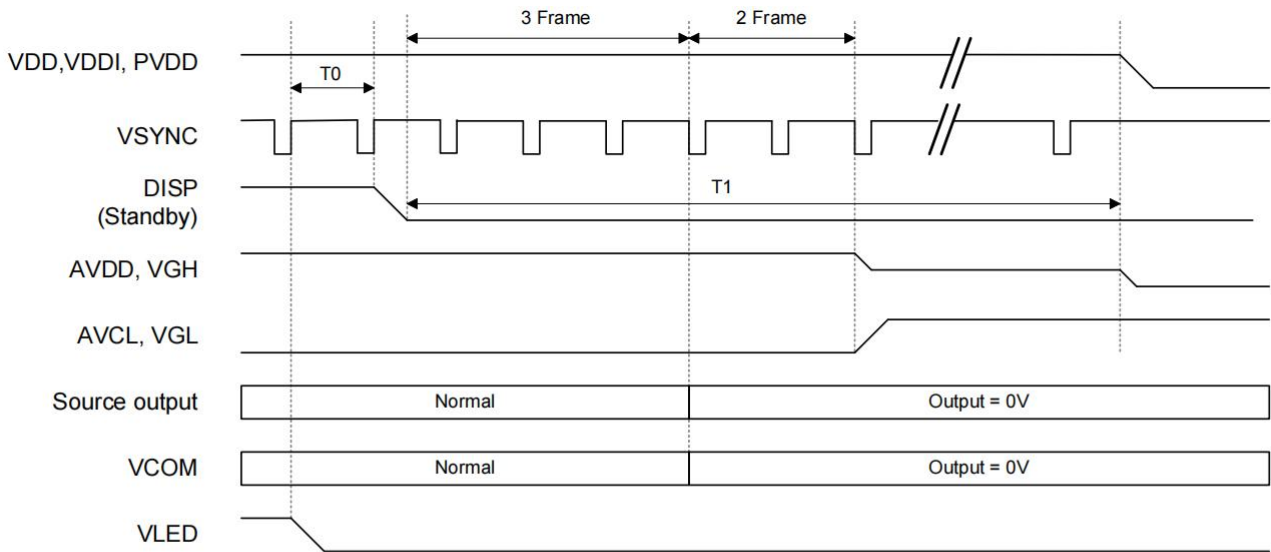

Item	Description	Min. Time
T0	Time from backlight power off to DISP="L"	1*Frame
T1	Time from DISP="L" to LCM Power off	5*Frame



## 2.2.3 RGB Interface

RGB Mode Selection Table	DCLK	HSYNC	VSYNC	DE
SYNC - DE Mode	Input	Input	Input	Input
SYNC Mode	Input	Input	Input	GND
DE Mode	Input	GND	GND	Input

Note: "Input" means these signals are driven by host side.

## 2.2.4 SYNC-Mode

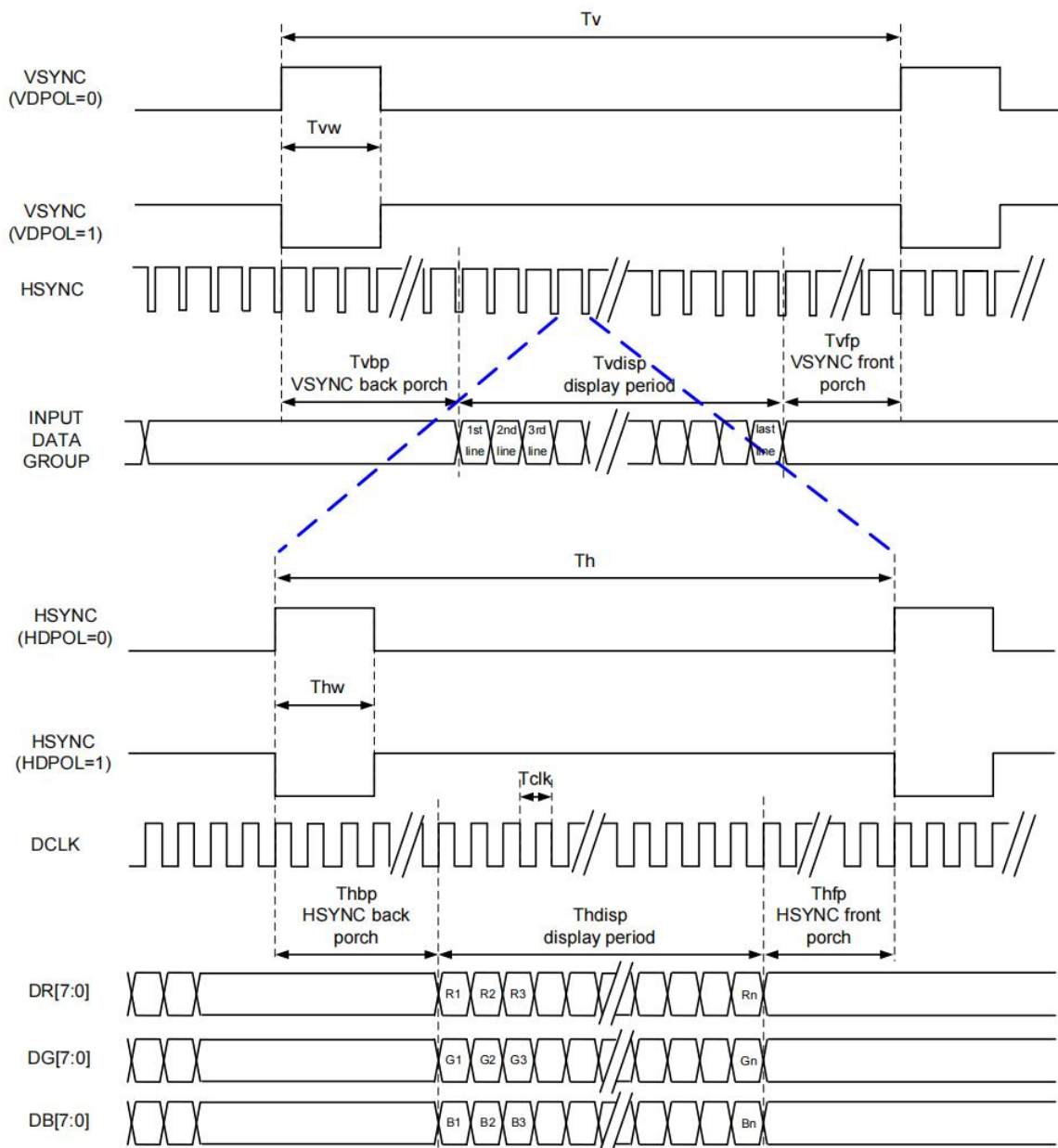



## 2.2.5 SYNC-DE Mode

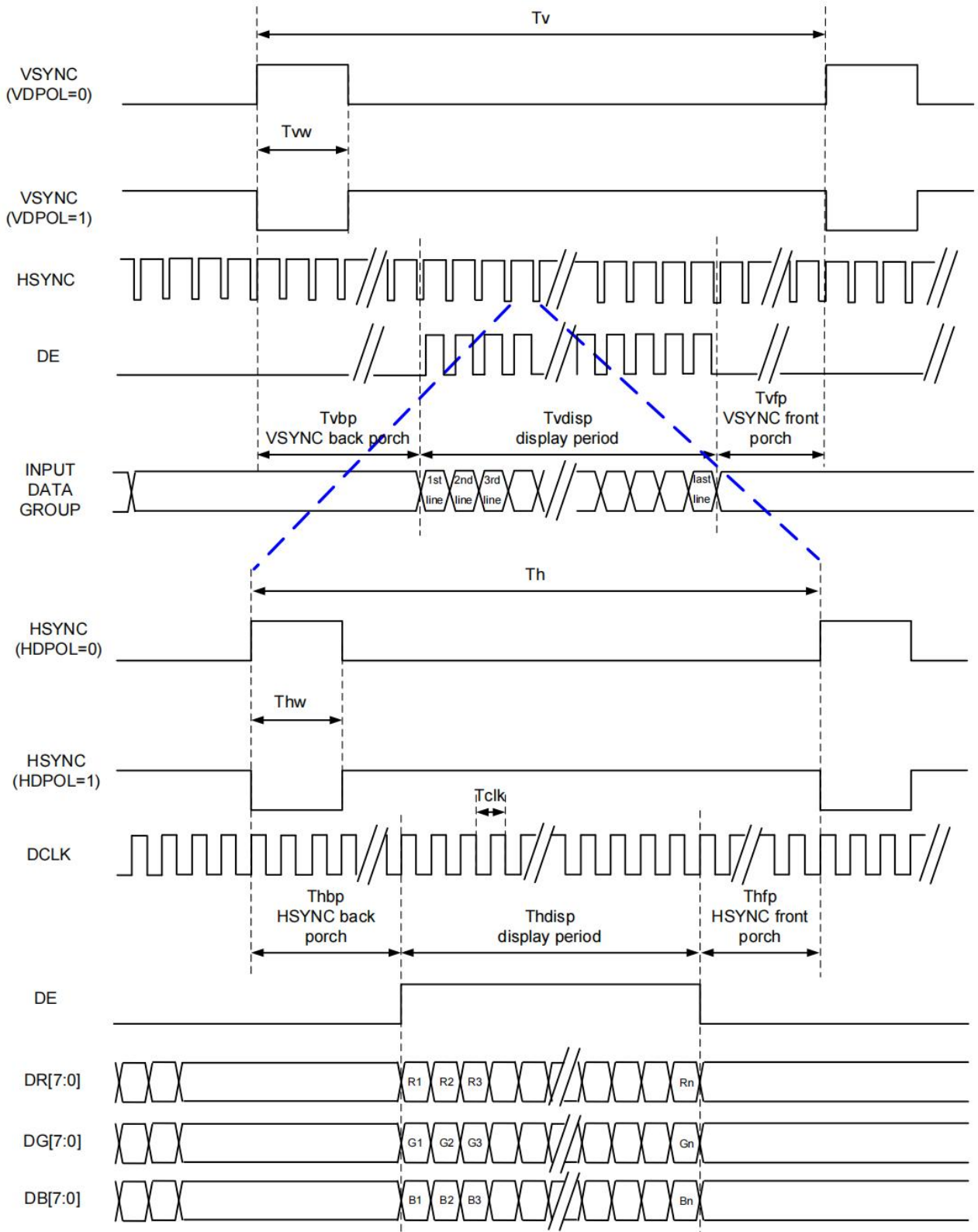



## 2.2.6 DE Mode

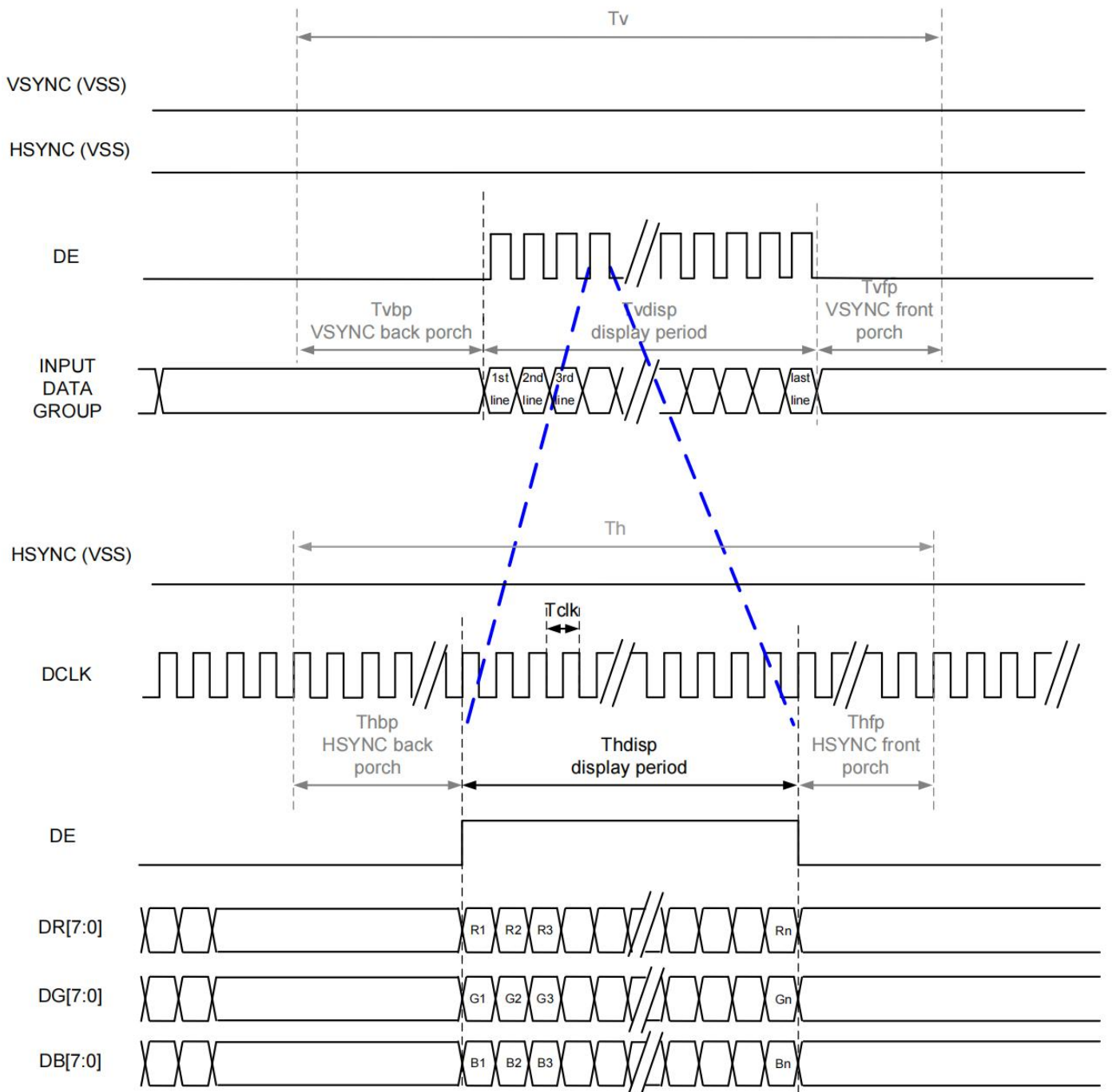



## 2.2.7 Parallel 24-bit RGB Input Timing Table

Parallel 24-bit RGB Input Timing (PVDD=VDD=VDDI= 3.3V, AGND= 0V, TA=25°C)

480RGB X 272 Resolution Timing Table							
Item	Symbol	Min.	Typ.	Max.	Unit	Remark	
DCLK Frequency	Fclk	8	9	12	MHz		
DCLK Period	Tclk	83	111	125	ns		
HSYNC	Period Time	Th	485	531	598	DCLK	
	Display Period	Thdisp	-	480	-	DCLK	
	Back Porch	Thbp	3	43	43	DCLK	By H_BLANKING setting
	Front Porch	Thfp	2	8	75	DCLK	
	Pulse Width	Thw	2	4	43	DCLK	
VSYNC	Period Time	Tv	276	292	321	HSYNC	
	Display Period	Tvdisp	-	272	-	HSYNC	
	Back Porch	Tvbp	2	12	12	HSYNC	By V_BLANKING setting
	Front Porch	Tvfp	2	8	37	HSYNC	
	Pulse Width	Tvw	2	4	12	HSYNC	

Note: It is necessary to keep Tvbp =12 and Thbp =43 in sync mode. DE mode is unnecessary to keep it.



## 3. Inspection Specification

- ◆Scope: The document shall be applied to TFT-LCD Module for 0.96" ~12.3" (Ver.A01).
- ◆Inspection Standard: MIL-STD-105E Table Normal Inspection Single Sampling Level II.
- ◆Equipment: Gauge、MIL-STD、SmartWin Tester、Sample
- ◆Defect Level: Major Defect AQL: 0.65 ; Minor Defect AQL: 1.5
- ◆OUT Going Defect Level: Sampling.
- ◆Standard of the product appearance test:

### a. Manner of appearance test:

- (1). The test best be under 20W×2 fluorescent light(about 300lux ~500lux)  
， and distance of view must be at 30~40 cm.
- (2). The test direction is base on about around 45° of vertical line.

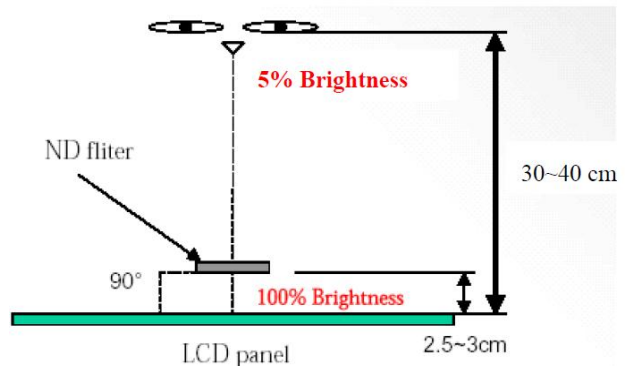
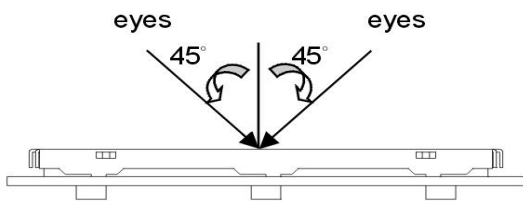

### (3). Definition of area.

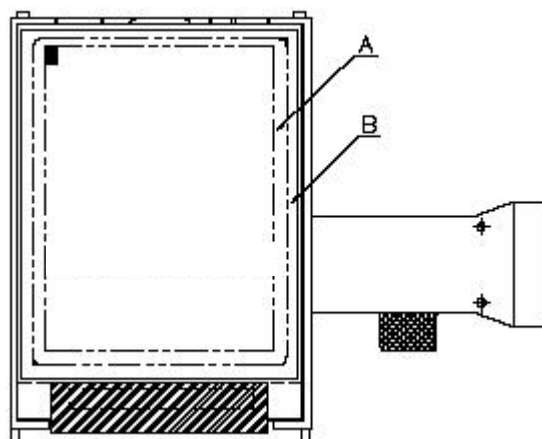

*A* area : viewing area

*B* area : Outside of viewing area

### (4). Standard of inspection: (Unit: mm)



### 3.1 Major defect

Item No	Items to be inspected	Inspection Standard
3.1.1	All functional defects	1) No display 2) Display abnormally 3) Short circuit 4) line defect
3.1.2	Missing	Missing function component
3.1.3	Crack	Glass Crack

### 3.2 Minor defect

Item No	Items to be inspected	Inspection Standard	
3.2.1	Polarizer dirt and spot	For dark/white spot is defined	
		$\varphi = (x+y) / 2$	
		Size $\varphi$ (mm)	Acceptable Quantity
		$\varphi \leq 0.15$	Ignore
		$0.15 < \varphi \leq 0.50$	2
$0.50 < \varphi$	0		

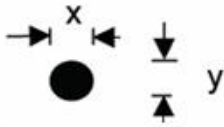
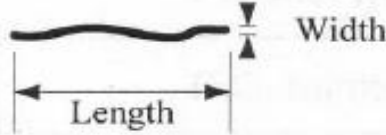

Item No	Items to be inspected	Inspection Standard	
3.2.2	Panel dirt and spot	For dark/white spot is defined $\varphi = (x+y) / 2$ 	
		Size $\varphi$ (mm)	Acceptable Quantity
		$\varphi \leq 0.10$	Ignore
		$0.10 < \varphi \leq 0.25$	3
		$0.25 < \varphi$	Not allowed
3.2.3	Line Defect Including Black line White line Scratch	Define: 	
		Width(mm) Length(mm)	Acceptable Quantity
		$W \leq 0.03$	Ignore
		$0.03 < W \leq 0.07$ $L \leq 5.0$	3
		$W > 0.07$	As round type



3.2.4	Polarizer Dent/Bubble	Size $\varphi$ (mm)		Acceptable Quantity
		$\varphi \leq 0.15$		Ignore
		$0.15 < \varphi \leq 0.50$		2
		$0.50 < \varphi$		0
3.2.5	Electrical Dot Defect	Item		Acceptance (Q'ty)
		Dot Defect	Bright dot	$\cong 4$
			Dark dot	$\cong 4$
<p>Inspection pattern: full white, full black, Red, Green and blue screens.</p> <p>It is defined as dot defect if defect area <math>&gt; 1/2</math> dot.</p> <p>The distance between two dot defect <math>\cong 5</math> mm.</p> <p>Bright dot that can not be seen through 2% ND filter.</p>				
3.2.6	Mura	Visible through ND5% at fullblack pattern is not allowed		



- Note:
1. Dot defect is defined as the defective area of the dot area is larger than 50% of the dot area.
  2. The distance between two bright dot defects (red, green, blue, and white) should be larger than 5mm.
  3. The distance between black dot defects or black and bright dot defects should be more than 5mm apart.

4. The definitions of the inner display area

And outer display area

I: Inner display area

O: Outer display area

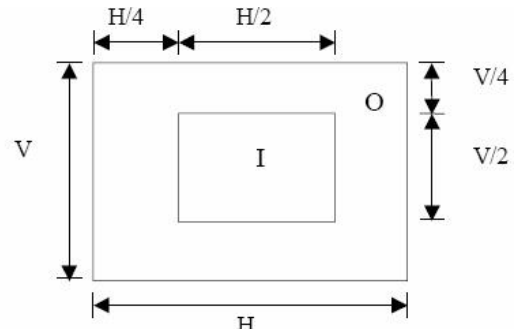

5. Polarizer bubble is defined as the bubble appears on active display area. The defect of polarizer bubble shall be ignored if the polarizer bubble appears on the outside of active display area.





## 5. PRECAUTION RELATING PRODUCT HANDLING

### 5.1 SAFETY

- 5.1.1 If the LCD panel breaks , be careful not to get the liquid crystal to touch your skin.
- 5.1.2 If the liquid crystal touches your skin or clothes , please wash it off immediately by using soap and water.

### 5.2 HANDLING

- 5.2.1 Avoid any strong mechanical shock which can break the glass.
- 5.2.2 Avoid static electricity which can damage the CMOS LSI—When working with the module , be sure to ground your body and any electrical equipment you may be using.
- 5.2.3 Do not remove the panel or frame from the module.
- 5.2.4 The polarizing plate of the display is very fragile. So , please handle it very carefully ,do not touch , push or rub the exposed polarizing with anything harder than an HB pencil lead (glass , tweezers , etc.)
- 5.2.5 Do not wipe the polarizing plate with a dry cloth , as it may easily scratch the surface of plate.
- 5.2.6 Do not touch the display area with bare hands , this will stain the display area.
- 5.2.7 Do not use ketonics solvent & aromatic solvent. Use with a soft cloth soaked with a cleaning naphtha solvent.
- 5.2.8 To control temperature and time of soldering is  $320\pm 10^{\circ}\text{C}$  and 3-5 sec.
- 5.2.9 To avoid liquid (include organic solvent) stained on LCM .
- 5.2.10 Caution!( LCM with Capacitive Touch Panel)Strong EMI-sources such as switch-mode power supplies (SMPS) can lead to touch malfunction (e.g. ghost-touches).Therefore, the touch needs to be thoroughly tested inside the target application.

### 5.3 STORAGE

- 5.3.1 Store the panel or module in a dark place where the temperature is  $25^{\circ}\text{C} \pm 5^{\circ}\text{C}$  and the humidity is below 65% RH.
- 5.3.2 Do not place the module near organics solvents or corrosive gases.
- 5.3.3 Do not crush , shake , or jolt the module.

### 5.4 TERMS OF WARRANTY

- 5.4.1 Applicable warrant period  
The period is within thirteen months since the date of shipping out under normal using and storage conditions.
- 5.4.2 Unaccepted responsibility  
This product has been manufactured to your company's specification as a part for use in your company's general electronic products. It is guaranteed to perform according to delivery specifications. For any other use apart from general electronic equipment , we cannot take responsibility if the product is used in nuclear power control equipment , aerospace equipment , fire and security systems or any other applications in which there is a direct risk to human life and where extremely high levels of reliability are required.

REV	REVISION RECORD	DATE
1	ACCORDING TO CUSTOM'S SPEC	2024-11-21
2	Add Edging Tape	2025-1-20

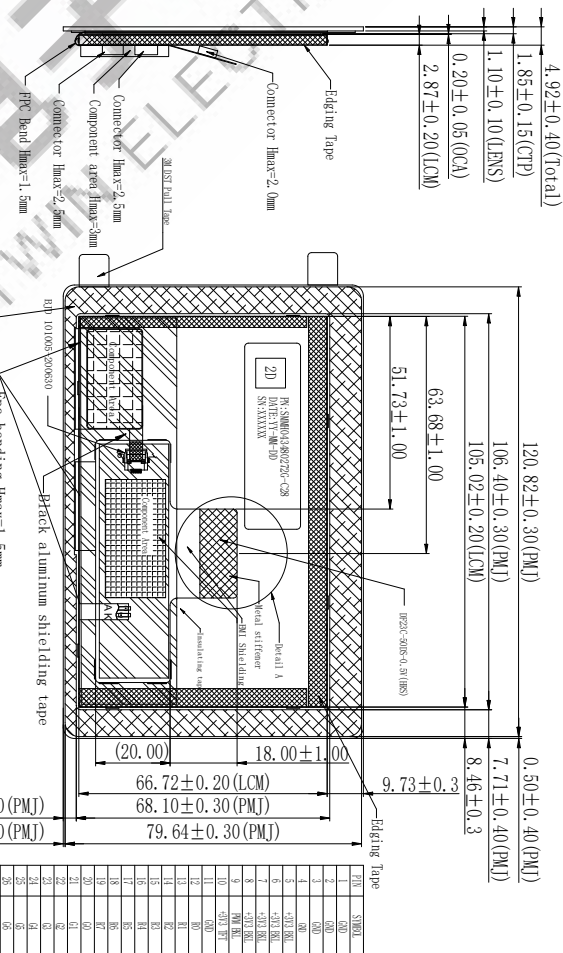
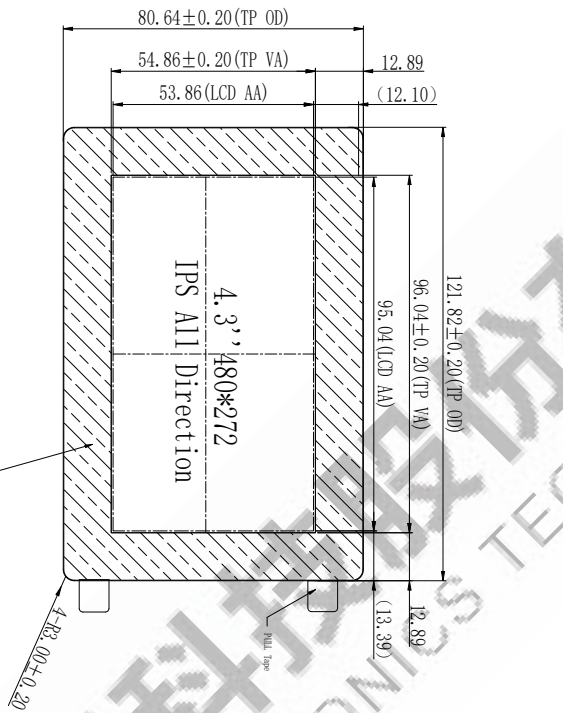

TP Connector:BJD 101005-200630

CTP Technical parameter  
 1. COVER GLASS+SENSOR+PC G+G Total thickness:  $2.0 \pm 0.15\text{mm}$ : on rear side  
 2. OPERATING VOLTAGE: IIC: VDD 3.3V;  
 3. Transmittance:  $\geq 86\%$   
 4. Surface hardness:  $\geq 6H$   
 5. Undeclared tolerance:  $\pm 0.2$   
 6. OPERATING TEMPERATURE:  $-30^{\circ}\text{C} \sim +80^{\circ}\text{C}$ ,  $\leq 80\%RH$   
 7. STORAGE TEMPERATURE:  $-30^{\circ}\text{C} \sim +80^{\circ}\text{C}$ ,  $\leq 85\%RH$   
 8. ROHS  
 9. Glass porometer:  $CS > 500\text{MPa}$ ,  $DOL > 10\text{um}$ ,  
 Note: CNI Recommended Matched connector DF23C-50DP-0.5V (HRS)

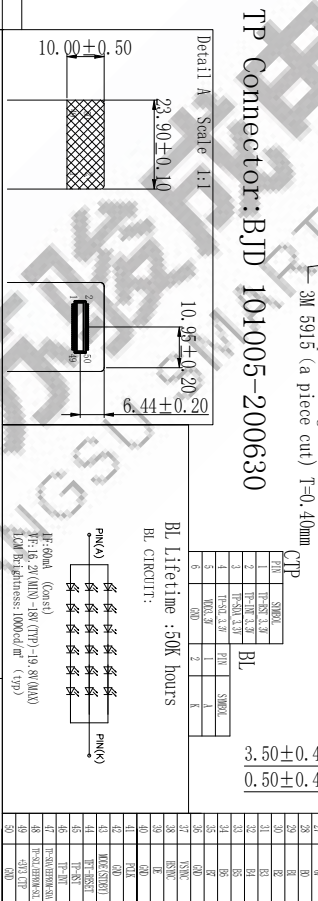

CONFIRM ALL TYPE DRAWINGS OF THIS AND PASS BACK!		OPERATING CURRENT: --
OPERATING VOLTAGE: 3.3V	VIEW DIRECTION: Free	CTP Interface: I <sup>2</sup> C
LCD Resolution: 480 (H) RGBX 272(V)	CTP CONTROLLER: ST16331	STORAGE TEMPERATURE: $-30^{\circ}\text{C}$ TO $80^{\circ}\text{C}$ (240hrs)
LCD CONTROLLER: ST7282A-66-L5	ROHS STANDARD: YES	ROHS STANDARD: YES
BACK LIGHT: If=60mA, Vf=18V (typ)		
OPERATING TEMPERATURE: $-30^{\circ}\text{C}$ TO $80^{\circ}\text{C}$ (240hrs)		
DEFAULT TOLERANCE: $\pm 0.2$		

TITLE	DESIGN BY	CHK'D BY	APPROVED
江苏骏成电子科技有限公司	洪康凯		
江苏骏成电子科技有限公司			
客户名称	产品型号	日期	比例
SM010434802726-C28		2025-1-20	1:1

FORMAT (6)