

Lautsprecher LSM-66A Art.-Nr.: 120082

Specification :

TYPE	UNIT	LSM-66A
Impedance	Ω	8 \pm 15%
Power (Nominal)	W	0.3
Power (Maximum)	W	0.5
Resonant Frequency	Hz	350 \pm 20%
Sound Pressure Level	dB	84 \pm 3
Frequency Range	Hz	Fo~3.500
Operating Temperature	$^{\circ}$ C	-10~+50
Storage Temperature	$^{\circ}$ C	-20~+60

Dimensions :

(Unit : mm)

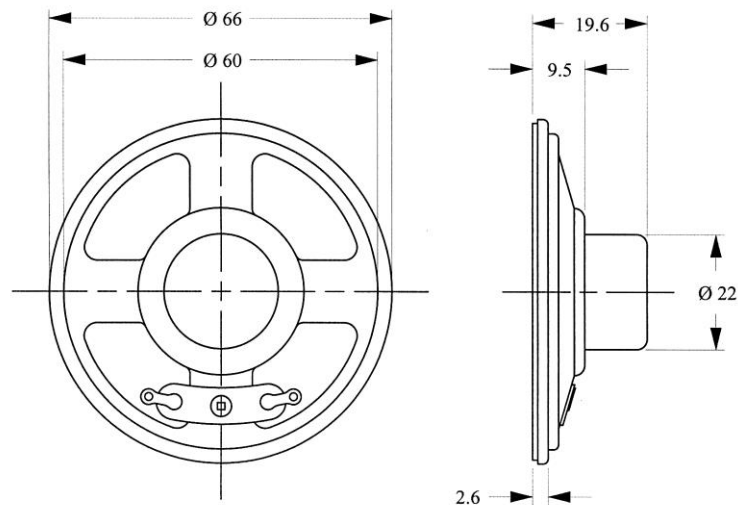

Frequency Response :

