

EXTRUSION

END PLATE

OPTIONAL FLANGE END PANELS 1455RF

EXTRUSION DESIGNED FOR 160MM WIDE PC BOARD

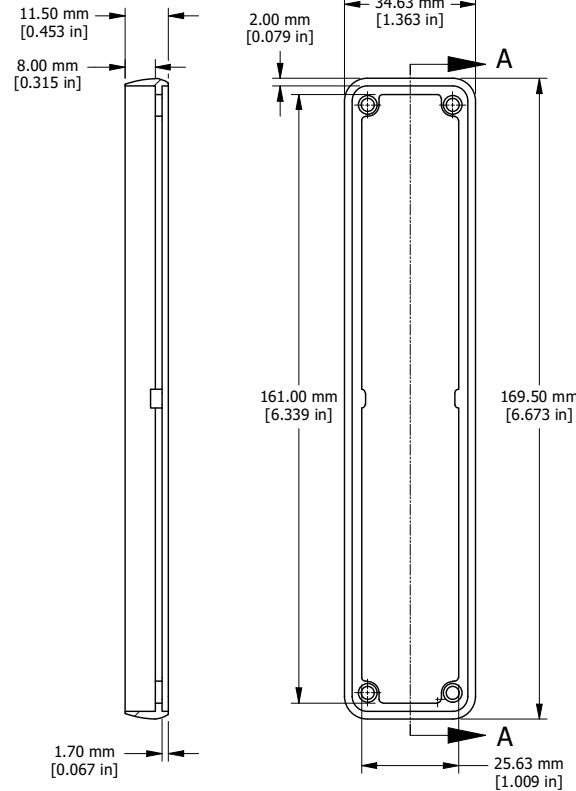
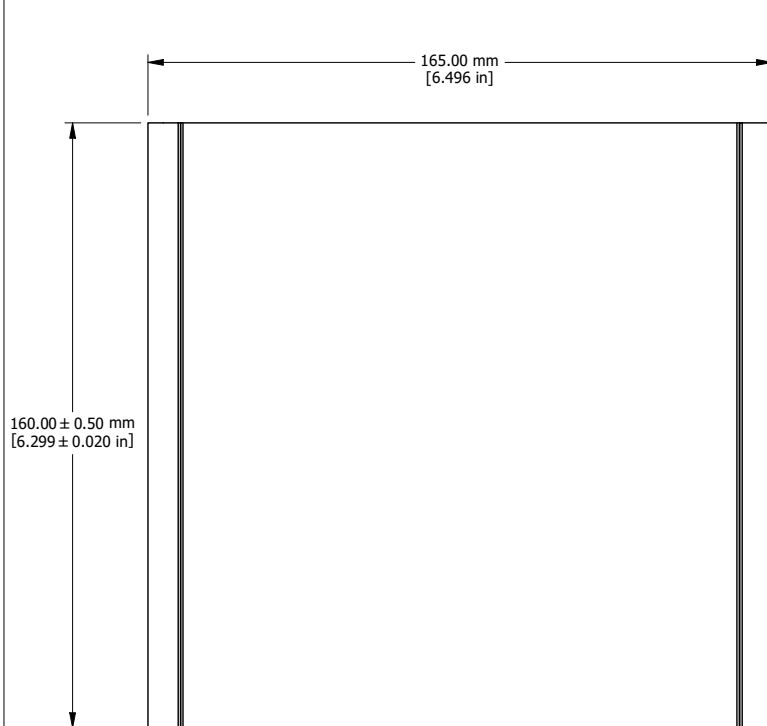

SECTION A-A

OPEN BEZEL

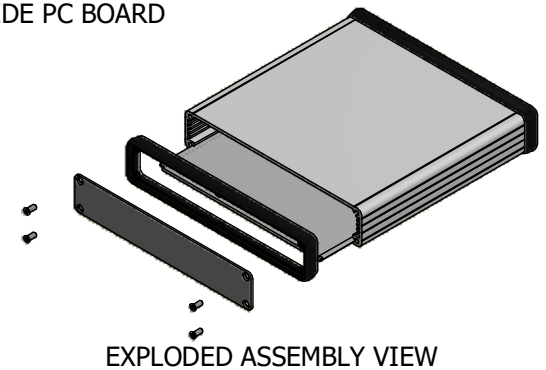

EXPLODED ASSEMBLY VIEW

Enclosures can be Factory Modified (Milling, Drilling, Printing etc.)
 Solid models of this enclosure available in STEP or IGES.
 Contact Factory mjm@hammondmfg.com

NOTE	
Purchased assembly includes box, plastic bezels, end panels, #6 Taptight screws and self adhesive rubber feet.	
Box made from Extruded Aluminum 6063.	
Bezels made with polycarbonate.	

1455R1601	
PART NUMBERS	
Clear Anodized	1455R1601
Black Anodized	1455R1601BK
Blue Anodized	1455R1601BU
Red Anodized	1455R1601RD
ACCESSORIES	
See website for accessories.	

HAMMOND MANUFACTURING™

1455R1601

www.hammondmfg.com