

**Technical specification/**

**Technische Daten:**

d Temperature range/ Temperaturbereich: - 35 °C ... + 85 °C

**Materials/**

**Werkstoffe:**

Hood/ Haube: ABS UL 94 V-0, Ni  
 Blanking plug/ Blindstopfen: ABS UL 94 V-0, Ni  
 Cable strain relief/ Zugentlastung: Steel, Ni  
 Clip/ Clip: Stainless Steel/ Edelstahl  
 Countersunk-head screw/ Linsenkopfschraube: Steel, Ni

**Installation specification/**

**Montagedaten:**

Cable outlet/ Kabelausgang: side/seitlich  
 Recommended torque/ Empfohlenes Drehmoment: 0,30 Nm  
 Housing/Gehäuse: 0,30 Nm  
 Cable strain relief/ Zugentlastung: 0,35 Nm

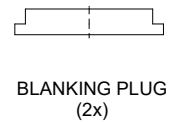
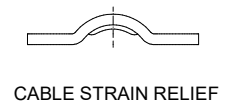
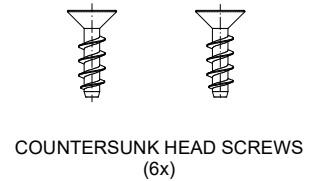
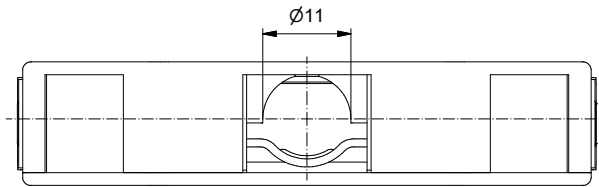
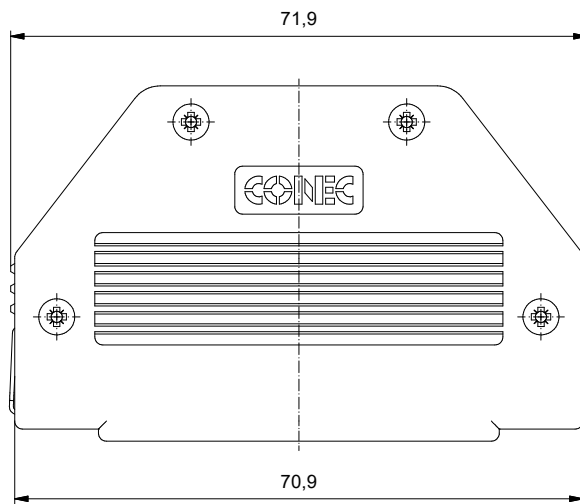
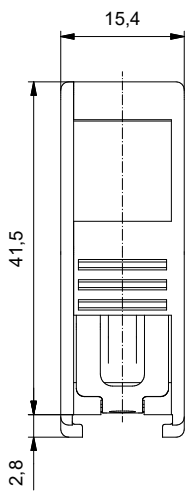

view without cover

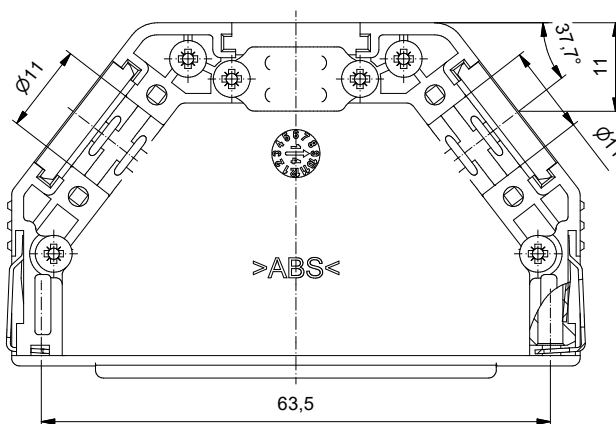

Part no./ Art.-Nr.  
16-001780

Index: d Ä22-0139 24.06.22 JLE	scale/ Maßstab: 1,5:1		dim. in mm	Plastic Hood 37 pos. with snap lock / top and two side cable exit Kunststoffhaube 37 pol. mit Schnellverriegelung und seitlichen Kabelausgang	dwg no / Z.-nr.: 16K1A3532	DIN-A3 1 / 1
			Date/ Datum: 25.09.2014 Name: Henneboel drawn/ gez.: 25.09.2014 appd./ gepr.: Strakerjahn			
RoHS compliant/ konform						

This reproduction, distribution and utilization of this document as well as the communication of its contents to others without express authorization is prohibited. Offenders will be held liable for the payment of damages. For further information on our copyright and liability issues, please refer to our website: www.conec.com.