

Piezosignalgeber RMP-28SW06-DT Art.-Nr. 185545

Specification:

TYPE	UNIT	RMP-28SW06-DT
• Min. Sound Output at 30cm	dB	90
Rated Voltage	VDC	6
Operating Voltage	VDC	4~9
Resonant Frequency	Hz	2800±100
• Max. Current Consumption	mA	15
Tone		Single
Operating Temperature	°C	-20~+70
Storage Temperature	°C	-30~+70
Weight	g	10

- Value applying at rated voltage

Dimensions:

(Unit: mm)

Wire: UL 1007 #28

AWG 28

LEAD TYPE

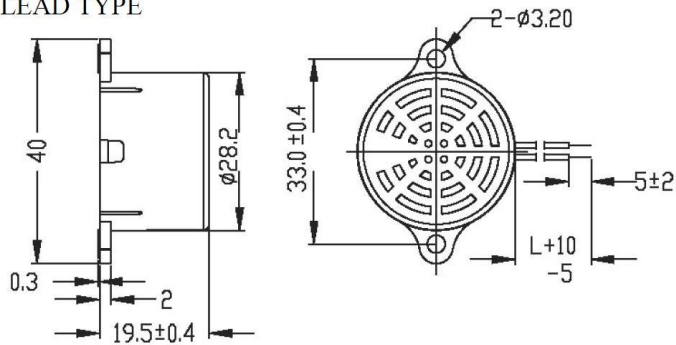

Frequency response:

