

Dimensions mm[inch]
tolerances according to DIN ISO 2768-m
Toleranzen gem. DIN ISO 2768-m

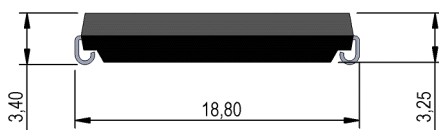

Schematic

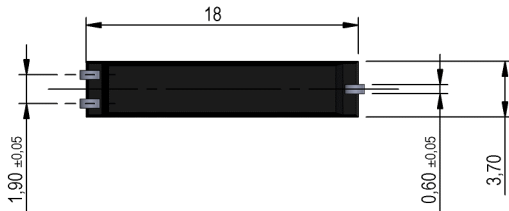
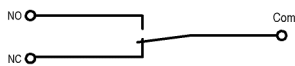

Isometric
Scale 2:1
Maßstab 2:1

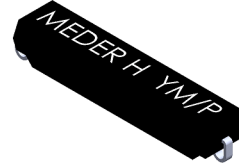

Recommended PCB Pad Layout

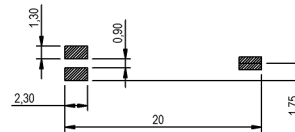

Marking

according to EN60062/factory code
gem. EN60062/Fertigungsstätte

MEDER H YM/P

Solder Reflow Profile

reflow soldering conditions according to JEDEC norm J-STD 020D.1

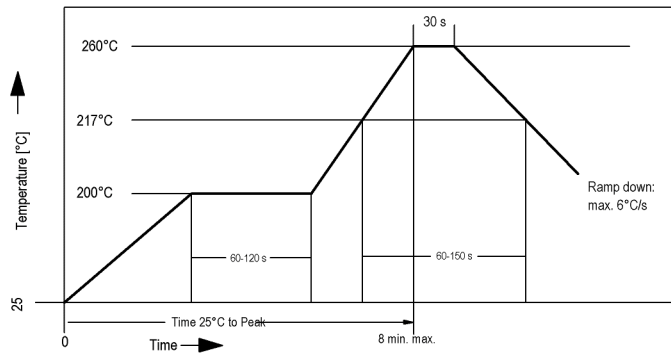

Contact packaging orientation

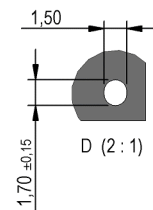
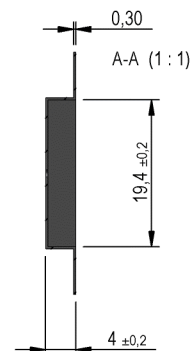
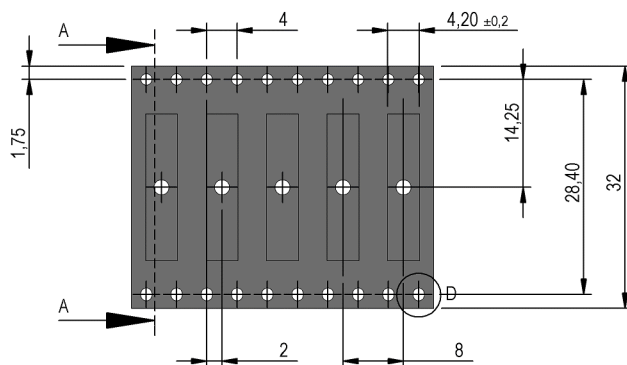



Europe: +49 / 7731 8399 0

| Email: info@standexmeder.com

Item No.:

USA: +1 / 508 295 0771

| Email: salesusa@standexmeder.com

2211000008

Asia: +852 / 2955 1682

| Email: salesasia@standexmeder.com

Item:

MK01-H

Magnetic properties	Conditions	Min	Typ	Max	Unit
Pull-In	at 20°C	42		84	
Test equipment			KMS-11		

Contact Data 94	Conditions	Min	Typ	Max	Unit
Contact-No.			94		
Contact-form			C		
Contact rating	Any DC combination of V & A not to exceed their individual max.'s			10	W
Switching voltage	DC or Peak AC			100	V
Carry current	DC or Peak AC			0,5	A
Switching current	DC or Peak AC			0,5	A
Contact resistance static	Measured with 40% overdrive Start Value			150	mOhm
Breakdown voltage (<21 AT)	according to IEC 255-5	150			VDC

Special Product Data	Conditions	Min	Typ	Max	Unit
Housing material			epoxy resin		
UL File Number			UL-File No. NRNT2.E156887		

Environmental data	Conditions	Min	Typ	Max	Unit
Shock	1/2 sine wave duration 11ms			30	g
Vibration	from 10 - 2000 Hz			20	g
Operating temperature		-20		130	°C
Storage temperature		-35		130	°C
Washability			fully sealed		

General data	Conditions	Min	Typ	Max	Unit
Total weight			0,4		g

Modifications in the sense of technical progress are reserved

Designed at: 24.04.09 Designed by: THAUKE

Approval at: 27.04.09 Approval by: JHEYDER

Last Change at: 18.10.17 Last Change by: THAUKE

Approval at: 20.10.17 Approval by: MREIZNER

Rev. No.: 8