

Top View of Assembly

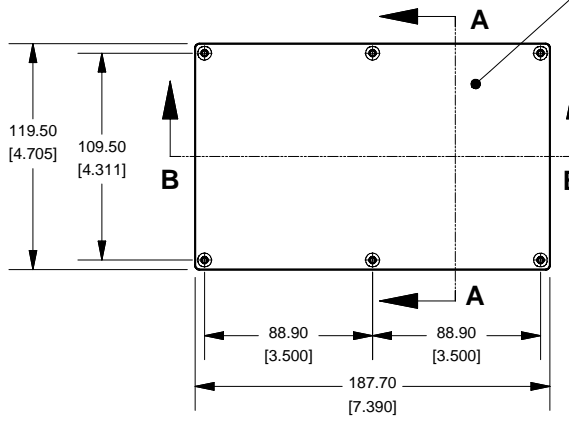

SECTION A-A End View of Assembly

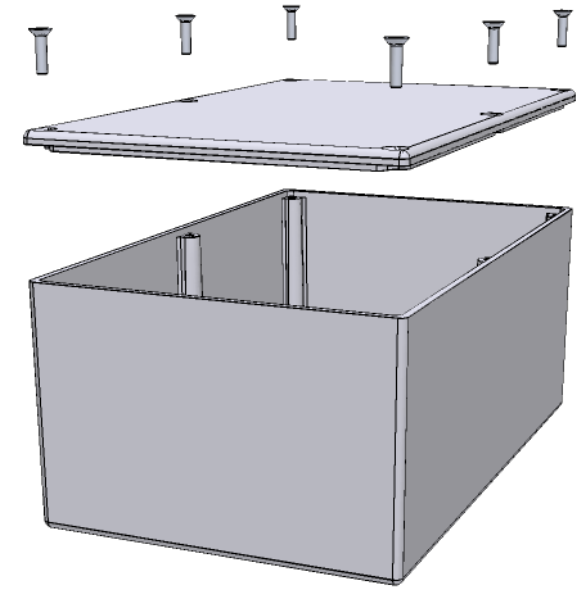
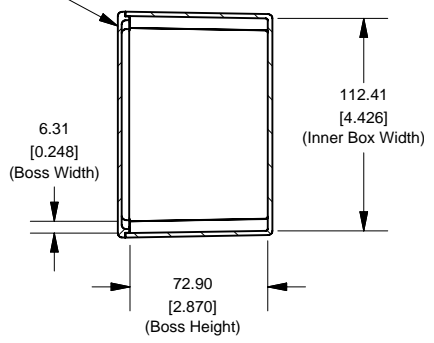

SECTION B-B Side View of Assembly

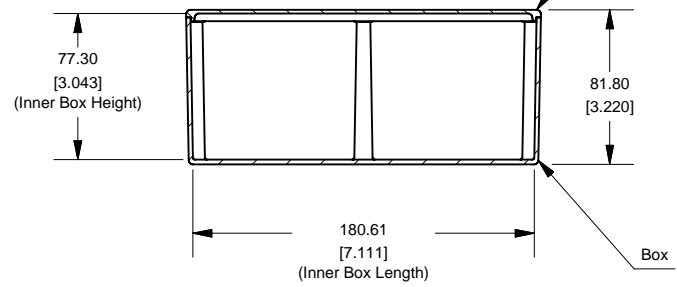

Lid

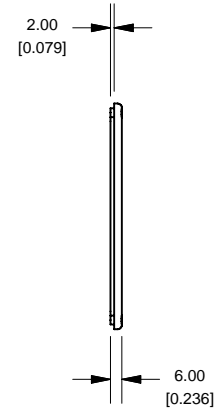
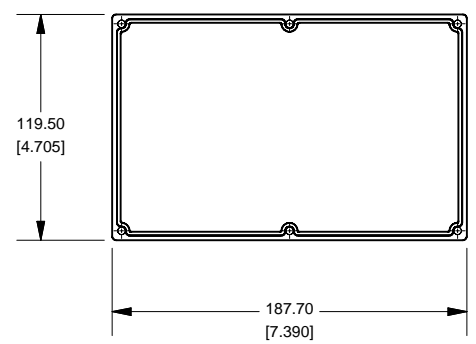

Enclosures can be Factory Modified (Milling, Drilling, Printing etc.)
Solid models of this enclosure available in STEP or IGES.
Contact Factory jelkins@hammond-electronics.co.uk

NOTE	
Purchased assembly includes Lid, Box and 6 cover screws.	
Eddystone 26357PSLA	
PART INFORMATION	
Part Number:	26357PSLA
Material:	LM2 / LM24 Diecast Aluminum Alloy
Cover Screw Type:	M3.5 x 10mm Countersunk (Screw Torque 75 oz f.in or 55 cN. m)

**HAMMOND
MANUFACTURING™**

26357PSLA
www.hammondmfg.com