

"Schutzvermerk nach DIN ISO 16016 beachten" "Please pay attention to copyright note DIN ISO 16016"

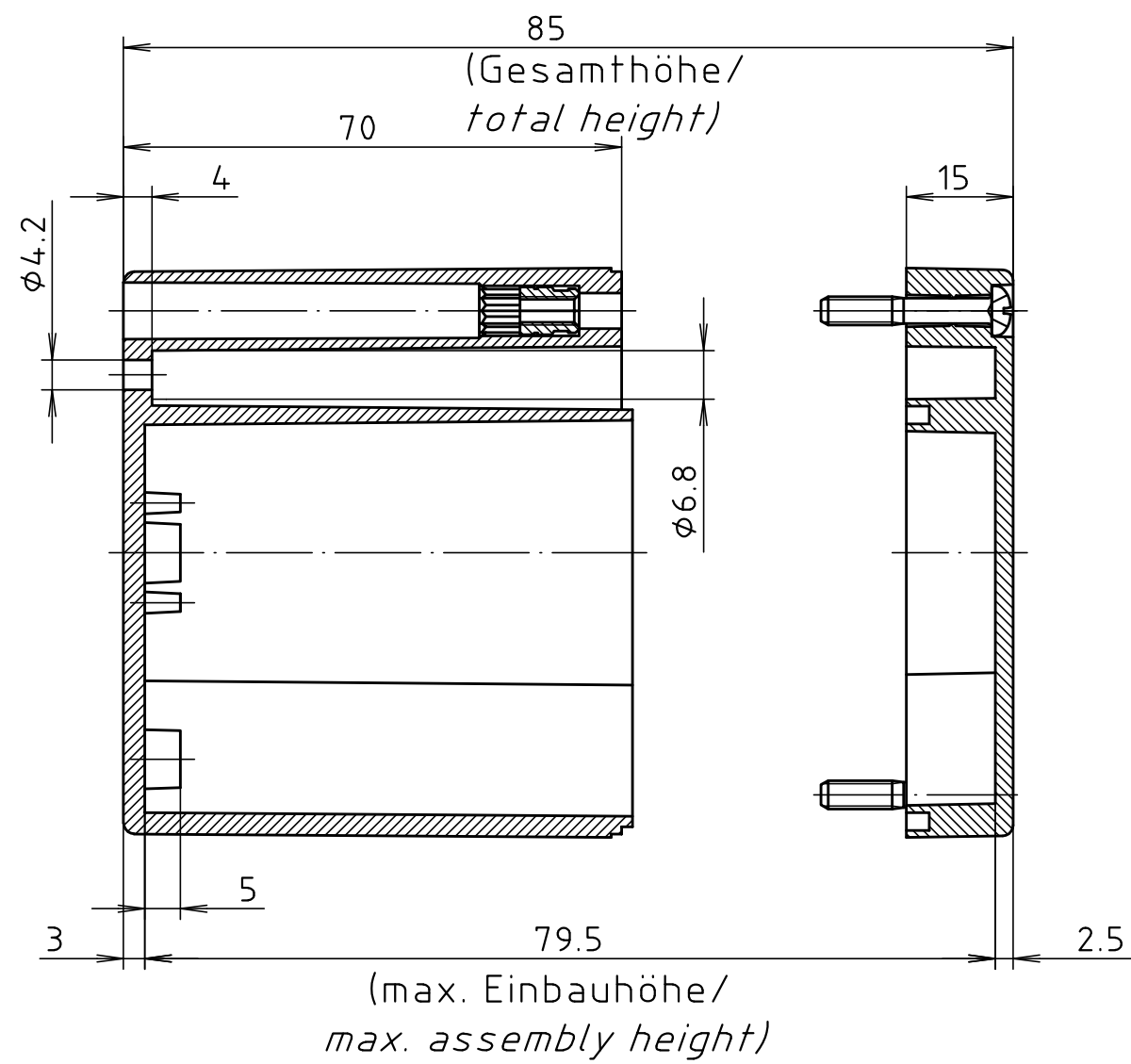
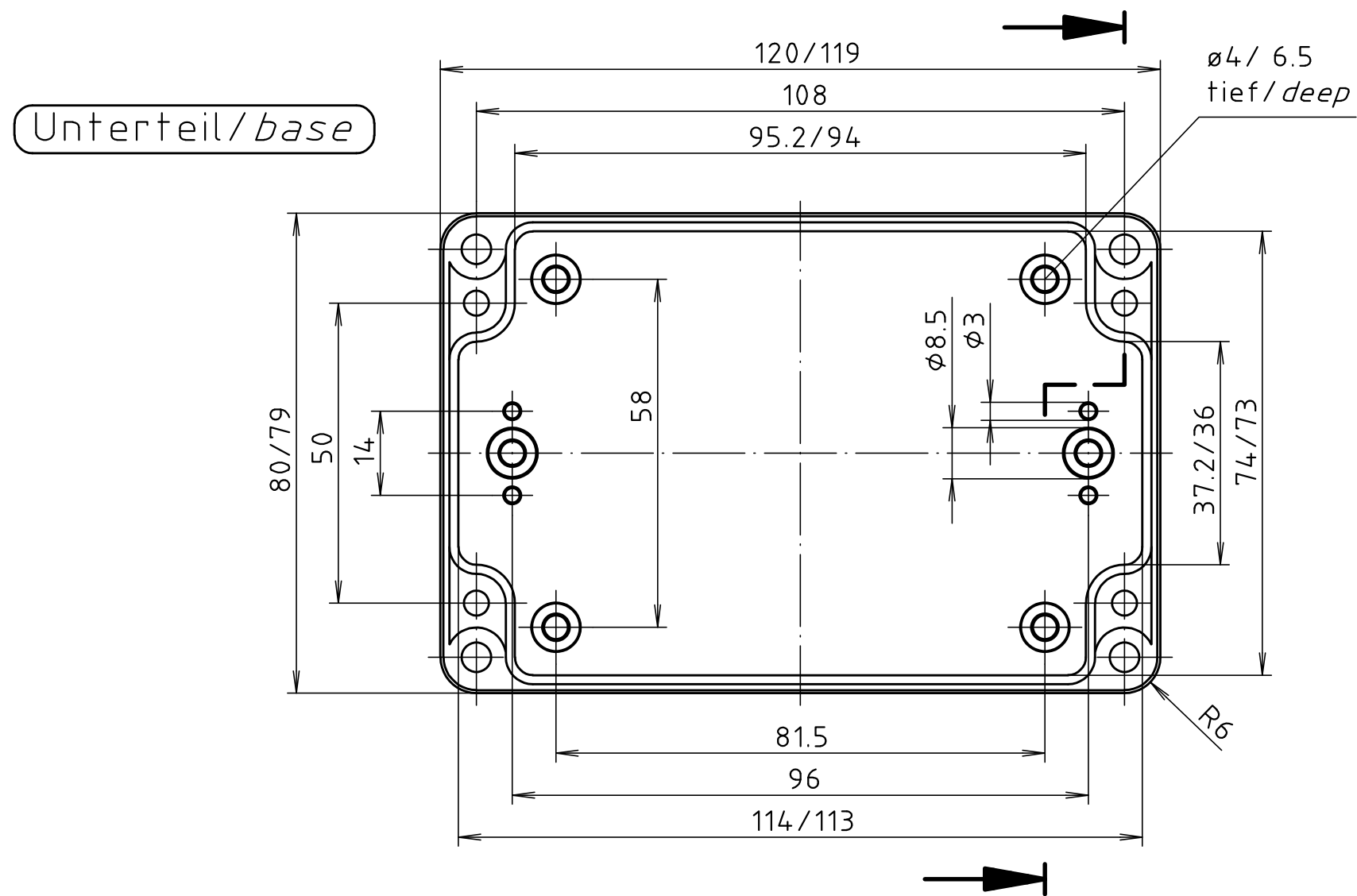
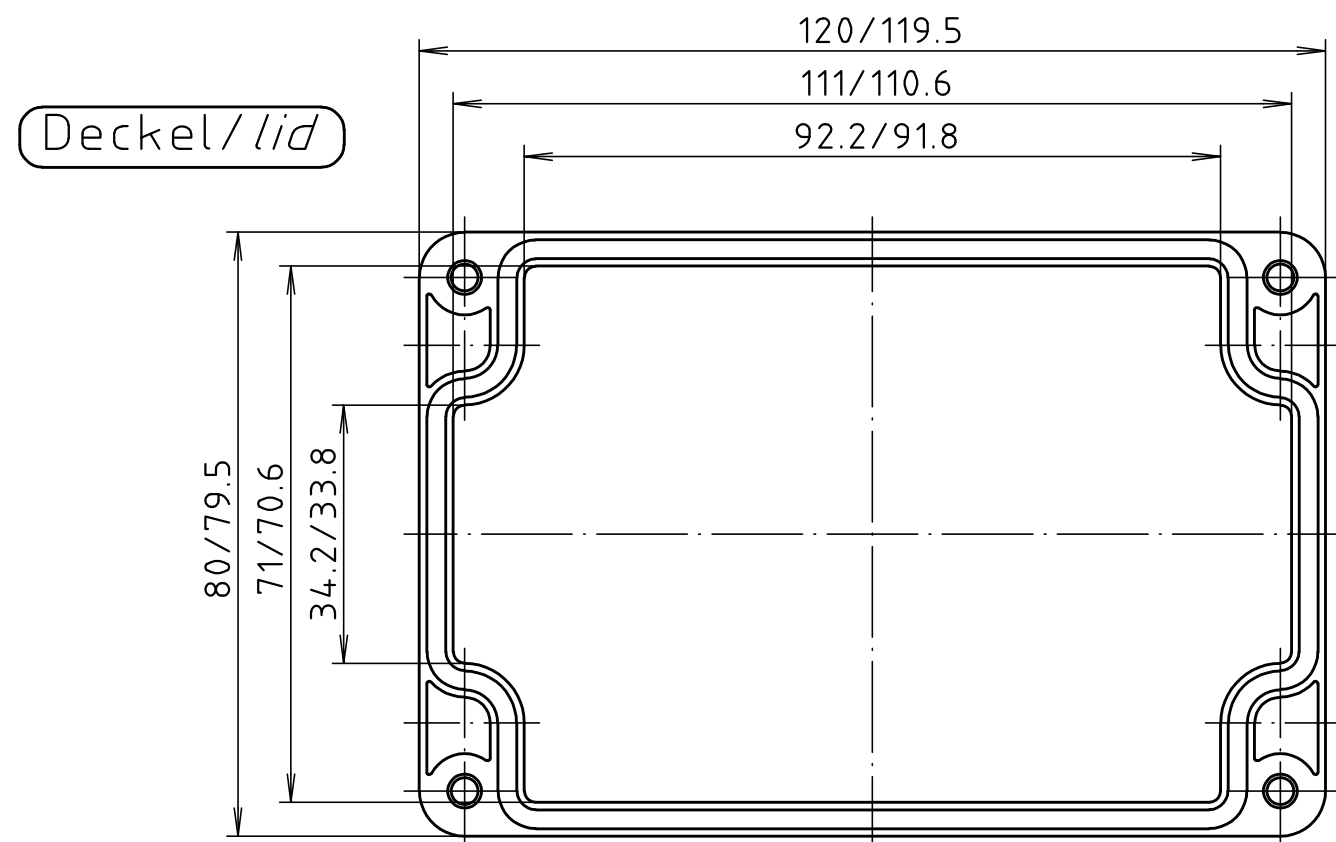

		Allgemein- toleranzen DIN .		Maßstab 1:1	Gewicht .
				Werkstoff PC	Rohteil-Nr. .
		Datum	Name	Benennung	
		Bearb. 22.01.20	ES	PC 220600 5U Gehäuse/ Enclosure	
		Gepr. .		Zchn.-Nr.	
		Norm .		5U220600	
Zust.	Anderung	Datum	Name	Urspr.:	Ers.für: .
					Ers.durch: .
					Blatt Bl.