

"Schutzvermerk nach DIN ISO 16016 beachten" "Please pay attention to copyright note DIN ISO 16016"

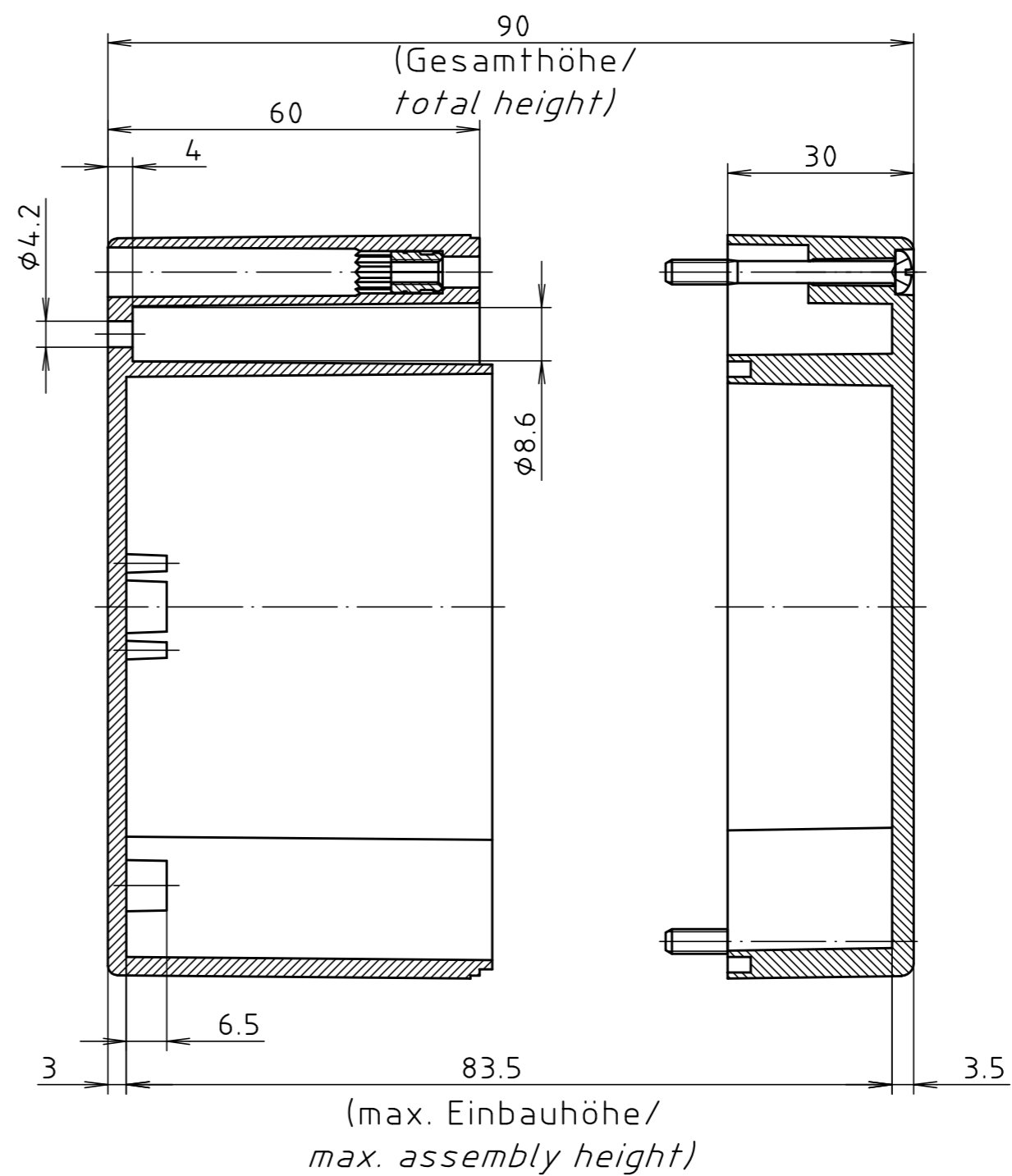
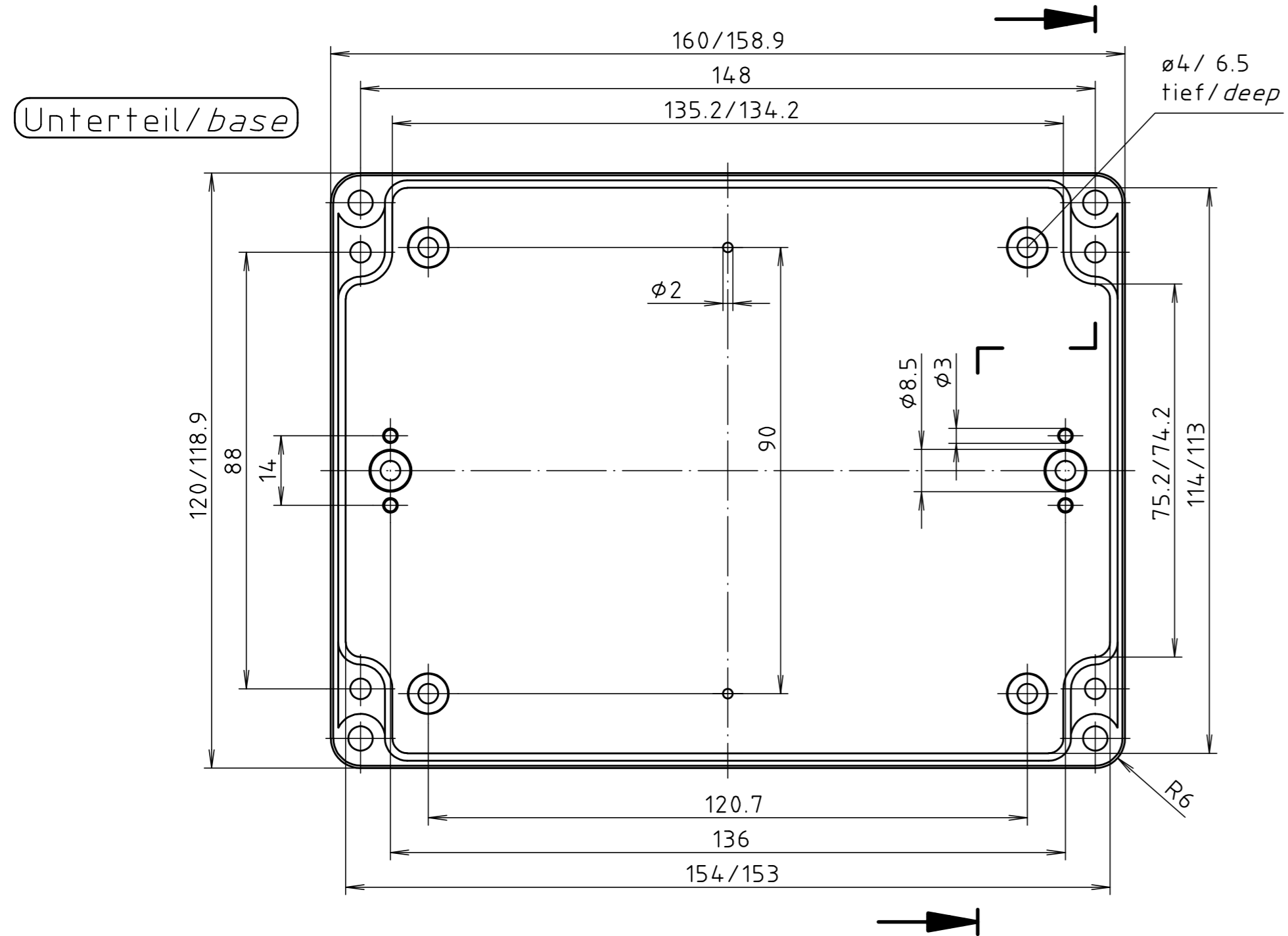
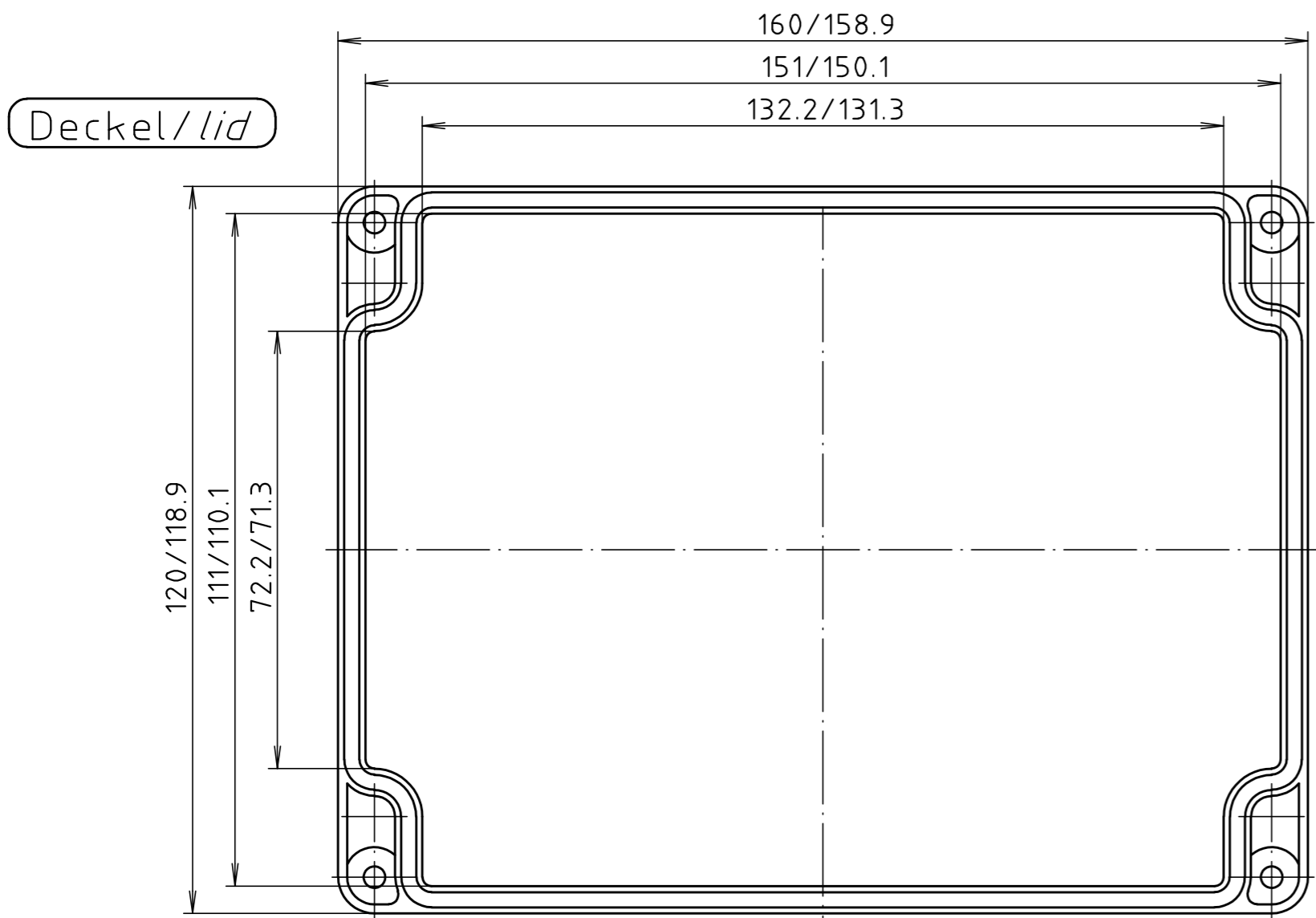

Allgemeintoleranzen DIN		Maßstab 1:1		Gewicht	
Werkstoff PC		Rohteil-Nr.			
Datum		Name		Benennung	
Bearb. 27.01.20		ES		PC 230800 5U Gehäuse/ Enclosure	
Gepr.				Zchn.-Nr.	
Norm				5U230800	
Zust.	Anderung	Datum	Name	Urspr.	Ers.für
					Ers.durch
				Blatt	Bl.