

Display Elektronik GmbH

DATA SHEET

**LCD MODULE**

**DEM 128048A SBH-PW-N**

*Product Specification*

*Version: 3*

22.10.2019

---

# GENERAL SPECIFICATION

MODULE NO. :

# DEM 128048A SBH-PW-N

CUSTOMER P/N:

Version No.	Change Description	Date
0	Original Version	12.07.2019
1	Correct the EXTERNAL DIMENSIONS & BACKLIGHT ELECTRICAL/OPTICAL SPECIFICATION	22.07.2019
2	Correct the EXTERNAL DIMENSIONS on page 4 and page 5(AK Pinlayout)& Correct the BACKLIGHT ELECTRICAL/OPTICAL SPECIFICATION on page 7(AK Pinlayout)	25.07.2019
3	Add the UL No. and correct the P/N No. on the FPC in the drawing	22.10.2019

**PREPARED BY: ZJ**

**DATE: 22.10.2019**

**APPROVED BY: MH**

**DATE: 22.10.2019**

**CONTENTS**

**1. FUNCTIONS & FEATURES .....4**

**2. MECHANICAL SPECIFICATIONS.....4**

**3 . BLOCK DIAGRAM.....5**

**4. EXTERNAL DIMENSIONS .....6**

**5.PIN DESCRIPTION .....7**

**6.BACKLIGHT ELECTRICAL/OPTICAL SPECIFICATION .....8**

**7. ABSOLUTE MAXIMUM RATINGS .....9**

**8. DC CHARACTERISTICS .....9**

**9. AC ELECTRICAL CHARACTERISTICS.....9**

**10. INSTRUCTION TABLE .....10**

**11. LCD ARTWORK.....11**

**12. SEG & COM LAYOUT .....11**

**13. IC LAYOUT .....12**

**14. MODULE ACCEPT QUALITY LEVEL (AQL).....12**

**15. RELIABILITY TEST .....12**

**16. QUALITY DESCRIPTION.....13**

**17. LCD MODULES HANDLING PRECAUTIONS.....14**

**18. OTHERS .....14**

**1. FUNCTIONS & FEATURES**

<b>Module</b>	<b>LCD Type</b>	<b>Remark</b>
DEM 128048A SBH-PW-N	STN-Blue Transmissive Negative Mode	---

- Viewing Direction : 6 O'clock
- Driving Scheme : 1/49 Duty Cycle, 1/8 Bias
- Power Supply Voltage : 3.3 Volt
- LCD Driving Voltage : 9.0 Volt
- Driver IC : ST7539
- Display Contents : 128 x 48 Dots

**2. MECHANICAL SPECIFICATIONS**

- Module Size : 40.00 x 17.15 x 5.50 mm (excl. FPC)
- View Area Size : 31.00 x 12.30 mm
- Active Area Size : 28.78 x 10.78 mm
- Dot Size : 0.205 x 0.205 mm
- Dot Gap : 0.02mm

**3. BLOCK DIAGRAM**

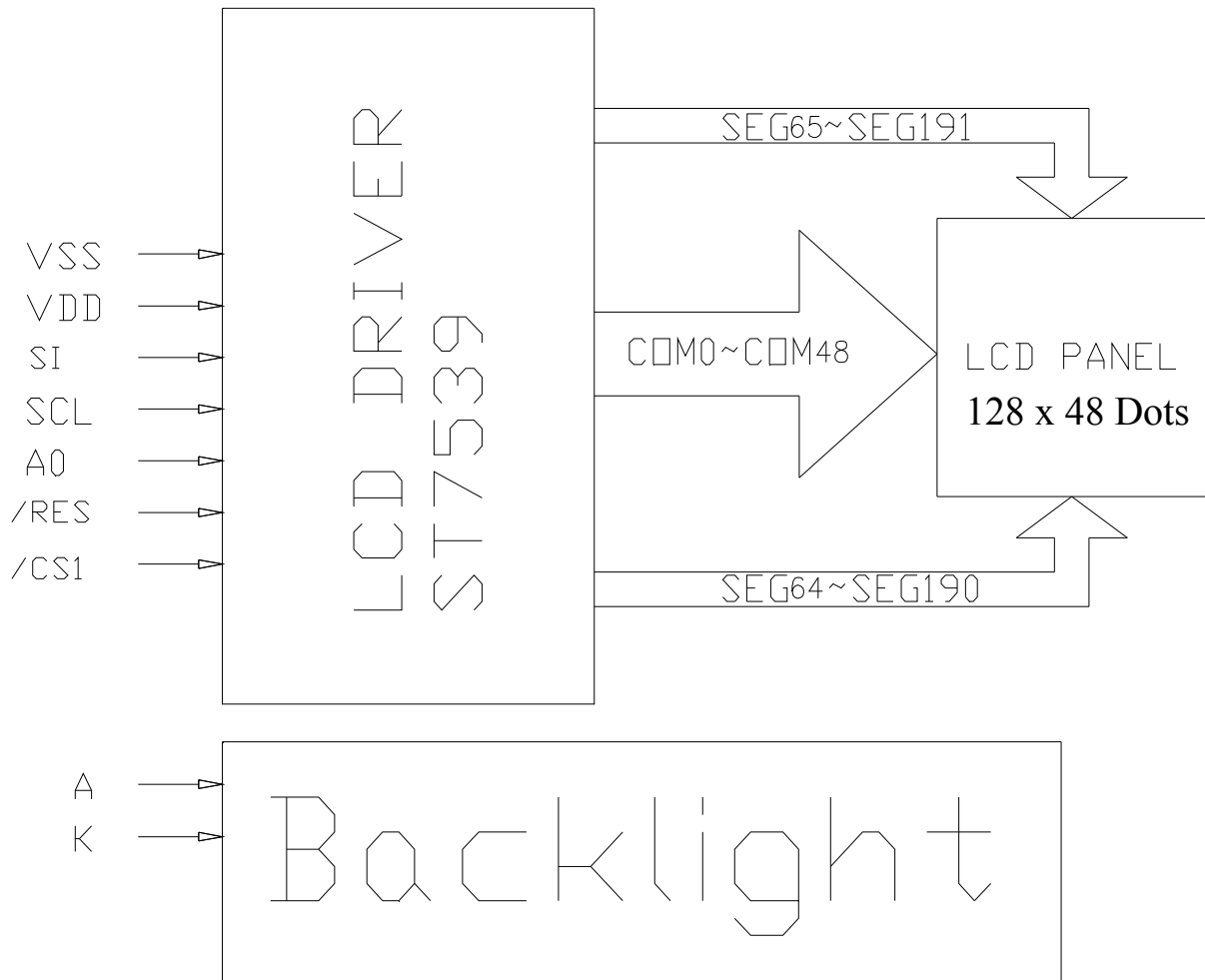

4. EXTERNAL DIMENSIONS

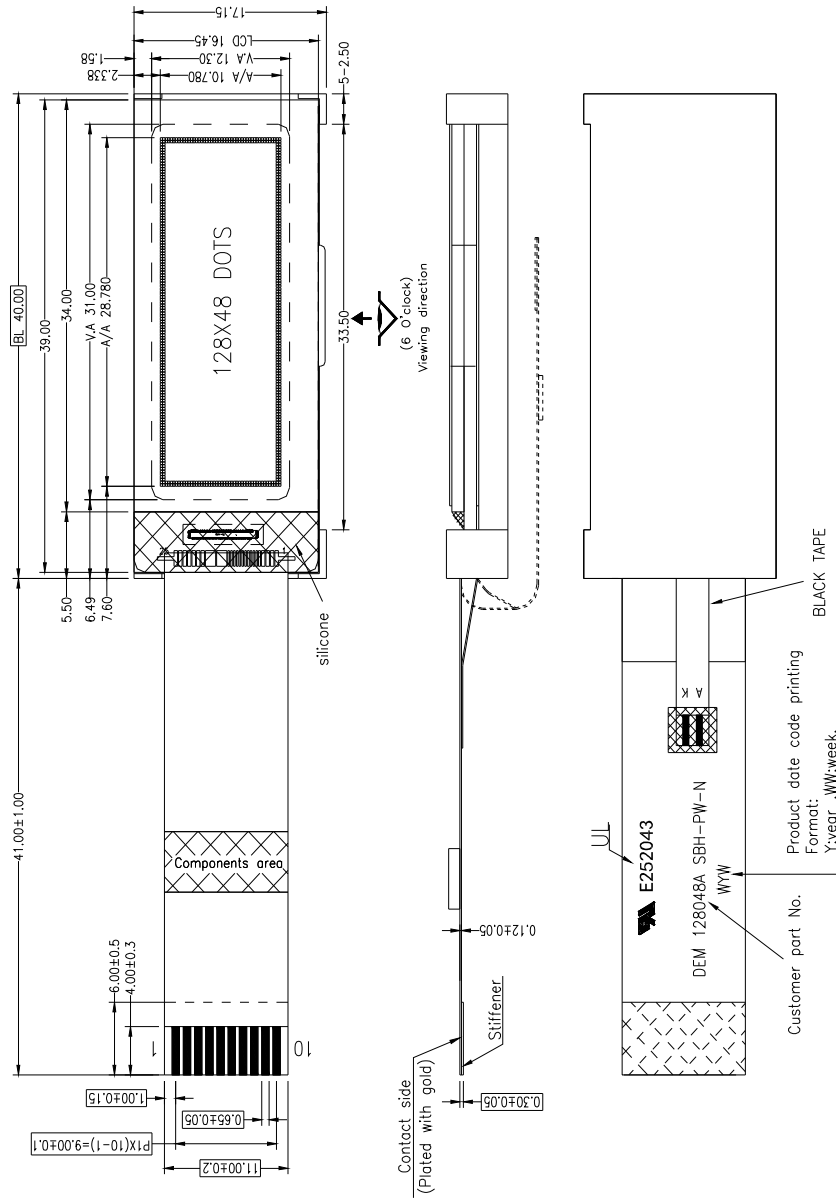

- Remarks:
1. Unmarked tolerance is ±0.3
  2. All materials comply with RoHS
  3.  ...:critical dimension.

**5. PIN DESCRIPTION**

<b>Pin No.</b>	<b>Name</b>	<b>Description</b>
1	/CS1	Chip select input pins
2	/RES	Reset input pin. When RST is “L”, internal initialization is executed.
3	A0	It determines whether the access is related to data or command. A0=“H”: Indicates that D[7:0] are display data. A0=“L”: Indicates that D[7:0] are control data.
4	SCL(D6)	Serial clock input.
5	SI(D7)	Serial input data.
6	NC	No Connection
7	VDD	Power Supply
8	VSS	Ground.
9	A	Power supply for backlight
10	K	Power ground For backlight

**6. BACKLIGHT ELECTRICAL/OPTICAL SPECIFICATION**

Electrical-Optical Characteristics (Ta=25°C)

Item	Symbol	MIN.	TYP.	MAX.	Unit	Condition
Forward Voltage	Vf	2.7	3	3.3	V	If= 15 mA
Colour Coordinate (Tolerances is ±0.01)	x	0.23	0.27	0.33		
	y	0.23	0.27	0.33		
Uniformity	Avg	70			%	
Luminance	Lv	1000	1300		cd/m <sup>2</sup>	
lifetime	50000 HOURS					

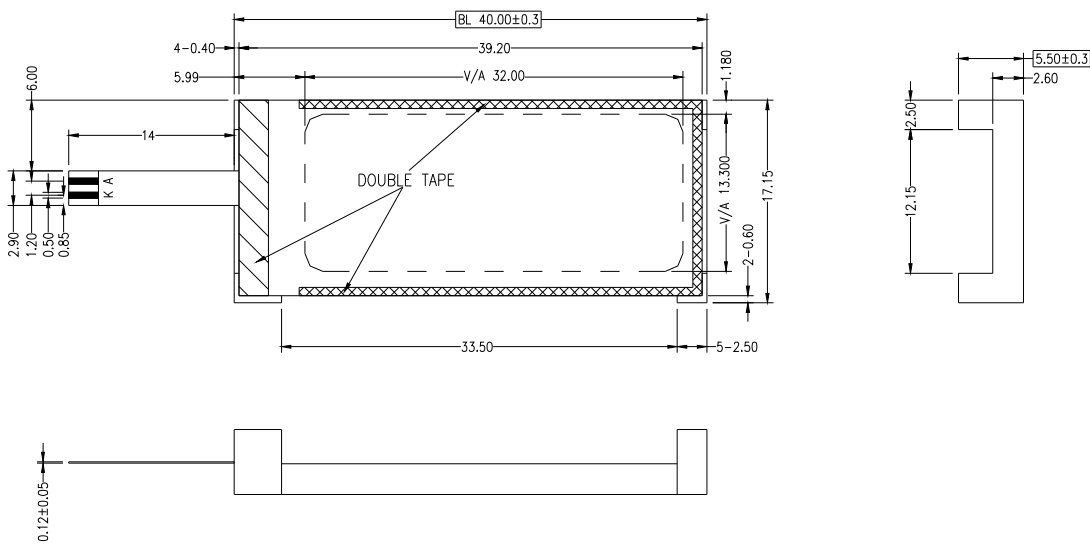

Remarks:

1. Unmarked tolerance is ±0.3
2. All materials comply with RoHs
3.  ...:critical dimension.

**Curcuit Diagram**



COLOR: WHITE



7. ABSOLUTE MAXIMUM RATINGS

Parameter	Symbol	Conditions	Unit
Power Supply Voltage	V <sub>DD</sub>	-0.3 ~ 4.0	V
LCD Supply Voltage	V <sub>OP</sub> (V0-XV0)	-0.3 ~ 13.0	V
LCD Supply Voltage	VG	-0.3 ~ 4.0	V
LCD Supply Voltage	VM	-0.3 ~ 4.0	V
Operating Temperature	T <sub>OPR</sub>	-20 ~ +70	°C
Storage Temperature	T <sub>STR</sub>	-30 ~ +80	°C

8. DC CHARACTERISTICS

Item	Symbol	Condition	Rating			Unit
			Min.	Typ.	Max.	
Supply Voltage	V <sub>DD</sub>		3.0	3.3	3.6	V
LCD Supply Voltage	V <sub>OP</sub>		8.7	9.0	9.3	V
Supply Current	I <sub>DD</sub>		---	TBD	---	uA

9. AC ELECTRICAL CHARACTERISTICS

SERIAL INTERFACE (4-Line Interface)

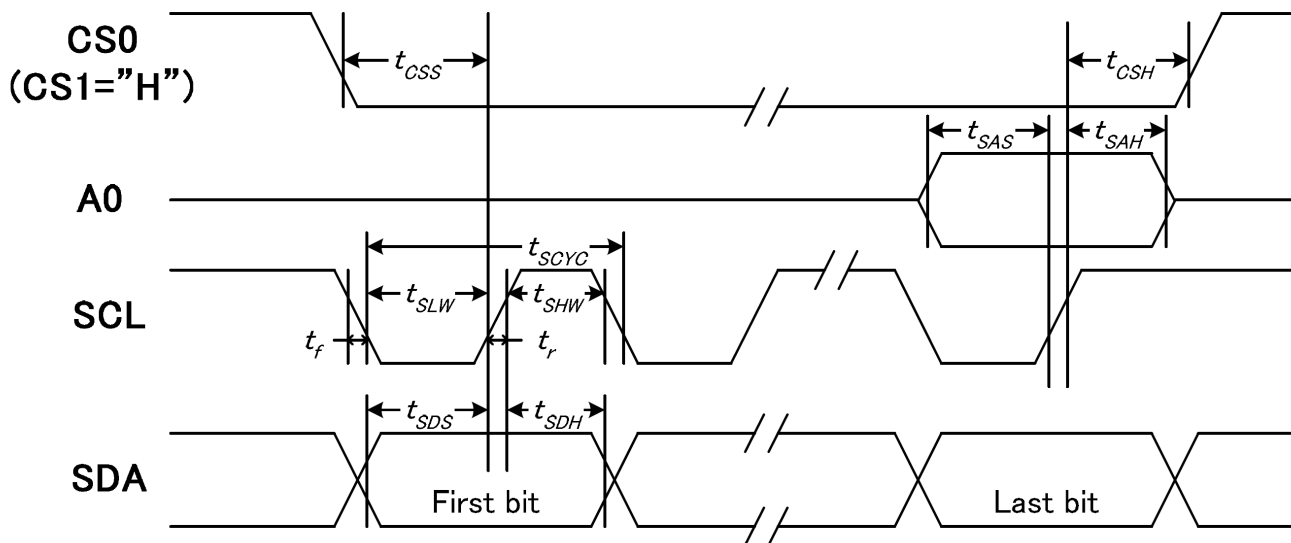

Item	Signal	Symbol	Condition	Min.	Max.	Unit
Serial clock period	SCL	tSCYC		60	-	ns
SCL "H" pulse width		tSHW		15	-	
SCL "L" pulse width		tSLW		15	-	
Address setup time	A0	tSAS		10	-	
Address hold time		tSAH		10	-	
Data setup time	SDA	tSDS		10	-	
Data hold time		tSDH		10	-	
CS0 setup time	CS0	tCSS		15	-	
CS0 hold time		tCSH		10	-	

10. INSTRUCTION TABLE

COMMAND TABLE											
INSTRUCTION	A0	R/W (RWR)	COMMAND BYTE								DESCRIPTION
			D7	D6	D5	D4	D3	D2	D1	D0	
Write Data	1	0	D7	D6	D5	D4	D3	D2	D1	D0	Write data to DDRAM
Read Data	1	1	D7	D6	D5	D4	D3	D2	D1	D0	Read data from DDRAM Only for parallel interface and I <sup>2</sup> C
Read Status Byte (parallel interface)	0	1	ID0	MX	MY	WA	DE	0	0	0	Read status byte Only for parallel interface
			0	POR	0	0	0	ID3	ID2	ID1	
Read Status Byte (4-SPI)	0	0	1	1	1	1	1	1	1	0	Read status byte Only for 4 line SPI
			0	POR	0	0	0	ID3	ID2	ID1	
Set Column Address LSB	0	0	0	0	0	0	CA3	CA2	CA1	CA0	Set column address of RAM
Set Column Address MSB	0	0	0	0	0	1	CA7	CA6	CA5	CA4	
Set Scroll Line	0	0	0	1	SL5	SL4	SL3	SL2	SL1	SL0	Specify line address for the 1 <sup>st</sup> display line of DDRAM (vertical scrolling)
Set Page Address	0	0	1	0	1	1	PA3	PA2	PA1	PA0	Set page address of RAM
Set Contrast	0	0	1	0	0	0	0	0	0	1	2-byte instruction. Set Vop voltage
			EV7	EV6	EV5	EV4	EV3	EV2	EV1	EV0	
Set Partial Screen Mode	0	0	1	0	0	0	0	1	0	PS	PS=1: Enable partial mode
Set RAM Address Control	0	0	1	0	0	0	1	AC2	AC1	AC0	Set column and page address behavior
Set Frame Rate	0	0	1	0	1	0	0	0	FR1	FR0	Set frame frequency
Set All Pixel ON	0	0	1	0	1	0	0	1	0	AP	Set all display segments on
Set Inverse Display	0	0	1	0	1	0	0	1	1	INV	Set inverse display
Set Display Enable	0	0	1	0	1	0	1	1	1	PD	PD=0: Chip is in power down mode
Scan Direction	0	0	1	1	0	0	0	MY	MX	0	Set COM and SEG scan direction
Software Reset	0	0	1	1	1	0	0	0	1	0	Set software reset
NOP	0	0	1	1	1	0	0	0	1	1	No operation
Set Bias	0	0	1	1	1	0	1	0	BR1	BR0	Set internal bias circuit
Set COM End	0	0	1	1	1	1	0	0	0	1	2-byte instruction. Set display duty
			--	--	CEN5	CEN4	CEN3	CEN2	CEN1	CEN0	
Partial Start Address	0	0	1	1	1	1	0	0	1	0	Set partial start for partial display screen
			--	--	DST5	DST4	DST3	DST2	DST1	DST0	
Partial End Address	0	0	1	1	1	1	0	0	1	1	Set partial end for partial display screen
			--	--	DEN5	DEN4	DEN3	DEN2	DEN1	DEN0	
Test Control	0	0	1	1	1	1	1	1	1	1	Set test command table
			--	--	--	--	--	--	H1	H0	

Note: 1. Do not use instructions not listed in these tables (Command Table).

2. "--" = Disabled bit. It can be either logic 0 or 1.

11. LCD ARTWORK

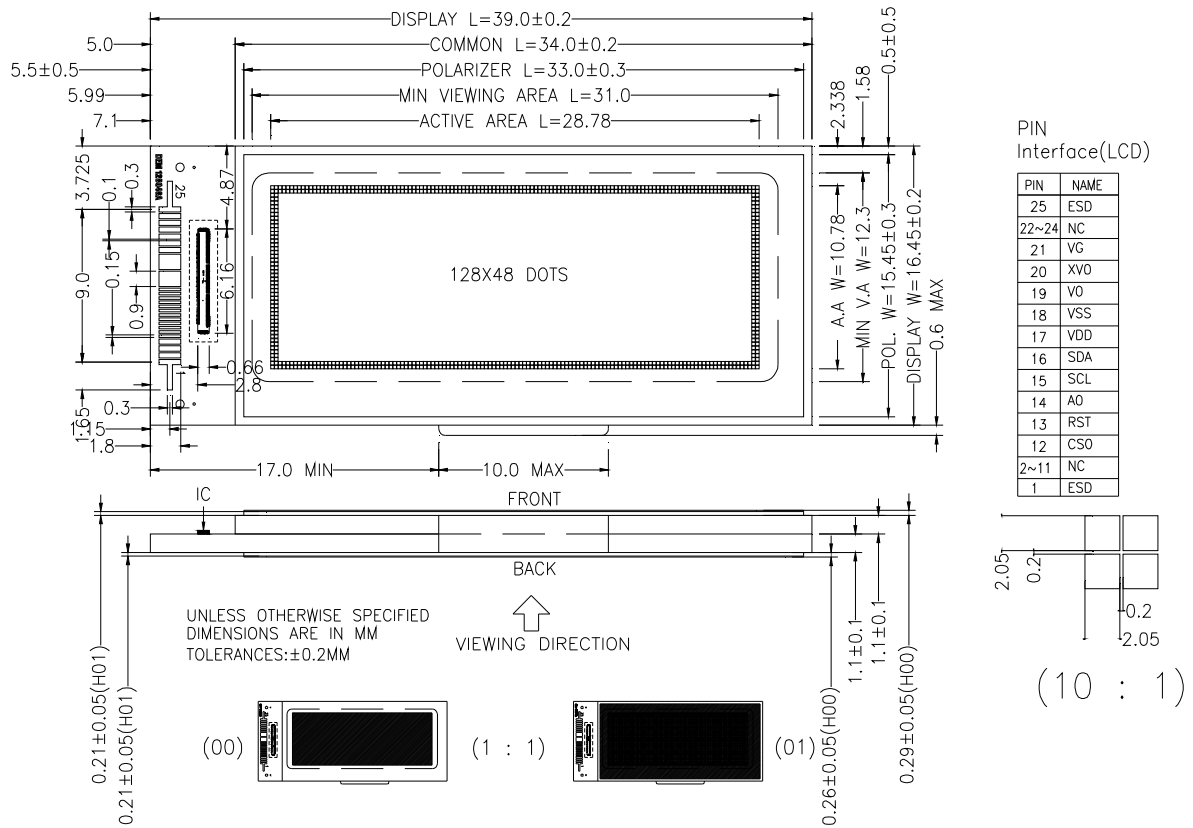

12. SEG & COM LAYOUT

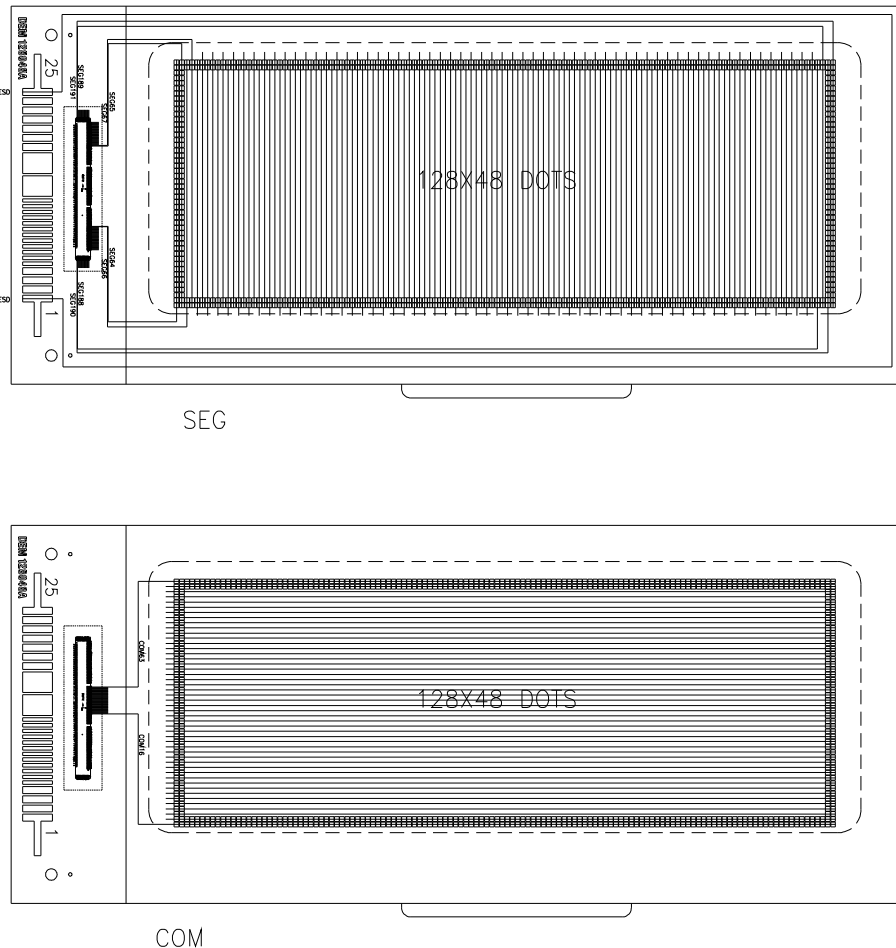

13. IC LAYOUT

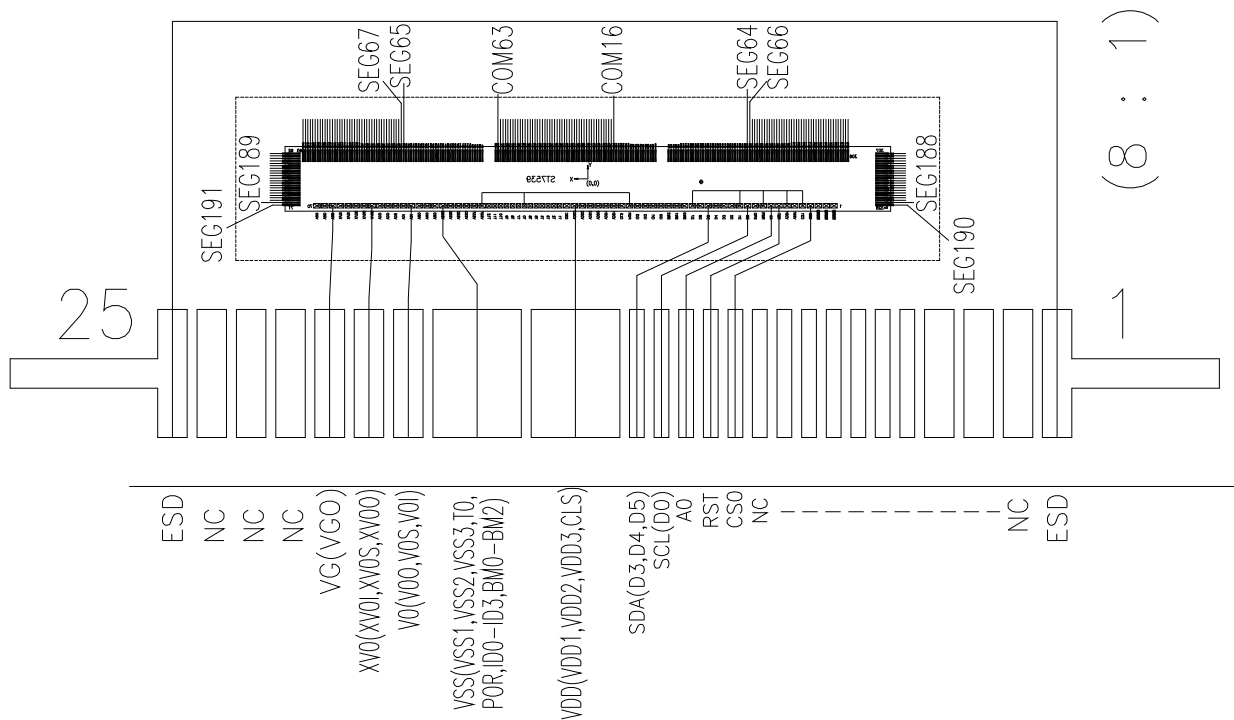

14. MODULE ACCEPT QUALITY LEVEL (AQL)

Inspection Standard: ANSI Z-1.4 Table Normal Inspection Single Sampling Level II.

15. RELIABILITY TEST

Operating life time: 50000h (at room temperature without direct irradiation of sunlight)  
 Reliability characteristics shall meet following requirements.

Tests Item	Condition
High Temperature Storage	+80°C x 96 hrs
Low Temperature Storage	-30°C x 96 hrs
High Temperature Operation	+70°C x 96 hrs
Low Temperature Operation	-20°C x 96 hrs
High Temperature, High humidity	+60°C x 90%RH x 96 hrs
Thermal Shock	-20°C x 30min → 25°C x 10s → +70°C x 30 min x 5 cycles
Vibration Test	Frequency x Swing x Time 40Hz x 4mm x 4hrs
Drop Test	Height x no. of drop 1.0m x 6 drops

16. QUALITY DESCRIPTION

DEFECT SPECIFICATION:

Specific type-related items are covered in this sheet.

- a: Table for Cosmetic defects  
(Note: nc = not counted).  
Sizes and number of defects  
(Max. Qty)

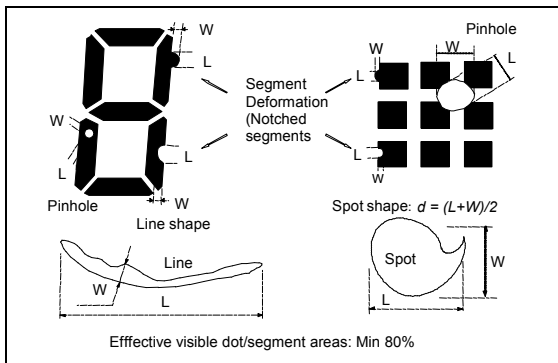

Examples/Shapes

- b: Glass defects
- b1: Glass defects at contact ledge

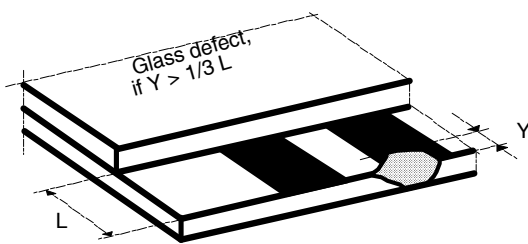

b2: Glass chipping in other areas shall not be in conflict with the product's function.

Defect Type	Max. defect size [ $\mu\text{m}$ ] d or L	W	Max. Quantity.
Black or White Spots	$d \leq 100$		nc
	$100 < d \leq 200$		5
Black or White Lines	--	$W \leq 10$	nc
	$L \leq 5000$	$W \leq 30$	3
	$L \leq 2000$	$W \leq 50$	2
Pinhole	$d \leq 100$		nc
	$100 < d \leq 200$		1/segment
(Total defects)			(5)
Segment Deformation		$W \leq 100$	nc
Bubble (e.g. under pola)	$d \leq 150$		nc
	$200 < d \leq 400$		3
	$400 < d \leq 600$		1

**17. LCD MODULES HANDLING PRECAUTIONS**

- Please remove the protection foil of polarizer before using.
- The display panel is made of glass. Do not subject it to a mechanical shock by dropping it from a high place, etc.
- If the display panel is damaged and the liquid crystal substance inside it leaks out, do not get any in your mouth. If the substance come into contact with your skin or clothes promptly wash it off using soap and water.
- Do not apply excessive force to the display surface or the adjoining areas since this may cause the color tone to vary.
- The polarizer covering the display surface of the LCD module is soft and easily scratched. Handle this polarize carefully.
- To prevent destruction of the elements by static electricity, be careful to maintain an optimum work environment.
  - Be sure to ground the body when handling the LCD module.
  - Tools required for assembly, such as soldering irons, must be properly grounded.
  - To reduce the amount of static electricity generated, do not conduct assembly and other work under dry conditions.
  - The LCD module is coated with a film to protect the display surface. Exercise care when peeling off this protective film since static electricity may be generated.
- Storage precautions  
When storing the LCD modules, avoid exposure to direct sunlight or to the light of fluorescent lamps. Keep the modules in bags designed to prevent static electricity charging under low temperature / normal humidity conditions (avoid high temperature / high humidity and low temperatures below 0°C). Whenever possible, the LCD modules should be stored in the same conditions in which they were shipped from our company.

**18. OTHERS**

- Liquid crystals solidify at low temperature (below the storage temperature range) leading to defective orientation of liquid crystal or the generation of air bubbles (black or white). Air bubbles may also be generated if the module is subjected to a strong shock at a low temperature.
- If the LCD modules have been operating for a long time showing the same display patterns may remain on the screen as ghost images and a slight contrast irregularity may also appear. Abnormal operating status can be resumed to be normal condition by suspending use for some time. It should be noted that this phenomena does not adversely affect performance reliability.
- To minimize the performance degradation of the LCD modules resulting from caused by static electricity, etc. exercise care to avoid holding the following sections when handling the modules:
  - Exposed area of the printed circuit board
  - Terminal electrode sections