

**DISPLAY Elektronik GmbH**

**DATA SHEET**

**LCD MODULE**

**DEM 128128B1 SBH-PW-N**

*Product Specification*

*Version: 1*

**15.08.2017**



**CONTENTS**

**1. FUNCTIONS &FEATURES .....2**

**2. MODULE ARTWORK .....2**

**3. EXTERNAL DIMENSIONS.....3**

**4. BLOCK DIAGRAM .....4**

**5. PIN ASSIGNMENT .....4**

**6. POWER SUPPLY .....5**

**7 PCB DRAWING AND DESCRIPTION .....5**

**8. ABSOLUTE MAXIMUM RATINGS( VSS=0V, TA=25°C) .....7**

**9. COMMAMD DEFINITIONS.....7**

**10. ELECTRICAL CHARACTERISTICS .....8**

**11. BACKLIGHT ELECTRICAL/OPTICAL SPECIFICATIONS..... 11**

**12. QUALITY DESCRIPTION .....12**

**13. MODULE ACCEPT QUALITY LEVEL (AQL) .....13**

**14. RELIABILITY TEST.....13**

**15. LCD MODULES HANDLING PRECAUTIONS.....14**

**16. OTHERS.....14**

**1. FUNCTIONS &FEATURES**

MODULE NAME	LCD Type
DEM 128128B1 SBH-PW-N	STN-Blue Transmissive Negative Mode

- Glass Thickness : 1.1mm
- Viewing Direction : 6 O'clock
- Driving Scheme : 1/128Duty, 1/12 Bias
- Power Supply for logic : 5.0 Volt (typ.)
- Backlight Color : LED, White
- Display Content : 128 x 128 Dots
- V<sub>LCD</sub> : 18.5 Volt (typ.)
- Operation Temperature : -20°C to +70°C
- Storage temperature : -25°C to +75°C
- Controller IC : UCi6963
- Driver IC : NT7086

**2. MODULE ARTWORK**

- Module Size : 106.00 x 92.00 x 14.10 mm
- Viewing Area : 73.00 x 73.00 mm
- Active Area : 70.35 x 70.35 mm
- Dot Pitch : 0.55 x 0.55 mm
- Dot Size : 0.50 x 0.50 mm
- Dot Gap : 0.05 mm



**4. BLOCK DIAGRAM**

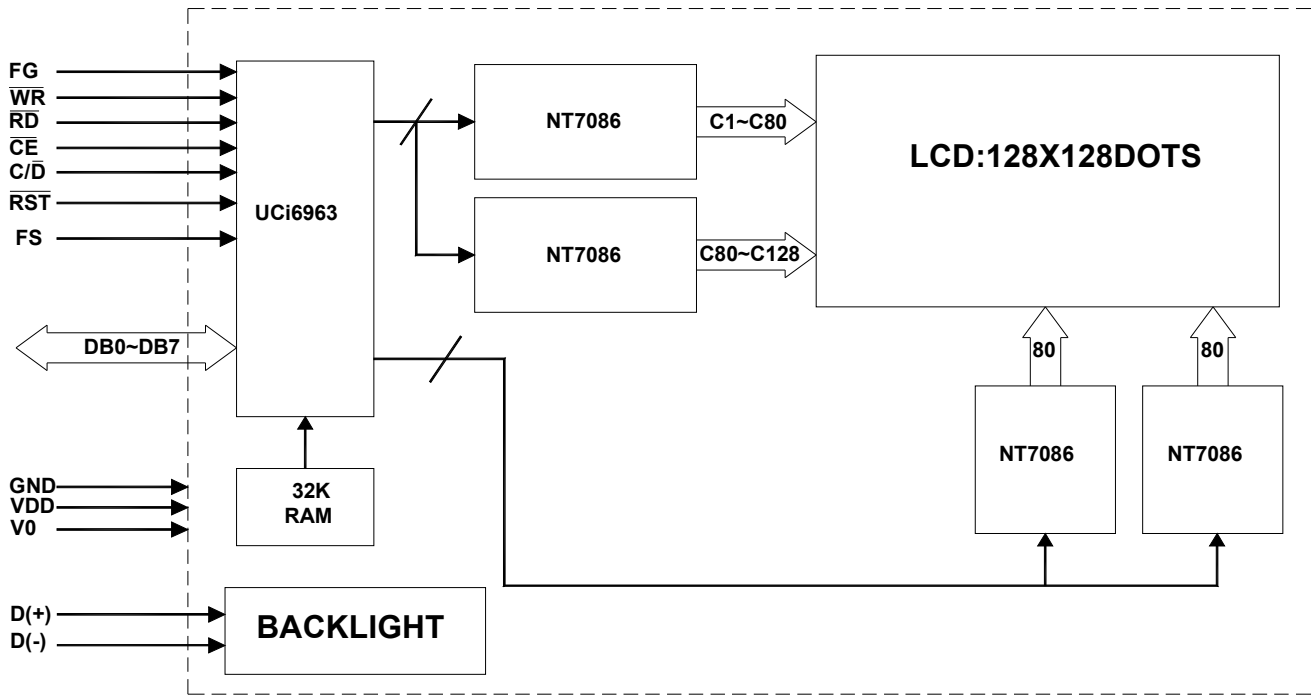

**5. PIN ASSIGNMENT**

NO.	SYMBOL	FUNCTION
1	FG	Frame ground (see note 1)
3	VSS	Ground (0V)
5	VDD	Power Supply(+5V)
7	V0	Power Supply for LCD Drive(-13.5V)
9	/WR	Data write. Write data to controller UCI6963 when “L”
11	/RD	Data read. Read data from controller UCI6963 when “L”
13	/CE	Chip enable of controller when “L”
15	C/ D	Command/Data read/write. “H” for command read/write and “L” for data read/write
17	/RST	Controller reset when “L”
19	DB0	Data input/output(LSB)
21	DB1	Data input/output
23	DB2	Data input/output
25	DB3	Data input/output
27	DB4	Data input/output
29	DB5	Data input/output
31	DB6	Data input/output
33	DB7	Data input/output(MSB)
35	FS	Font select. “H” for 6x8 font & “L” for 8x8 font
37	LED+(A)	Anode of LED backlight
39	LED-(K)	Cathode of LED backlight

Note: This pin is electrically connected to the metal bezel (frame), but is otherwise not connected. User can choose to connect this pin to ground or leave it open.

6. POWER SUPPLY

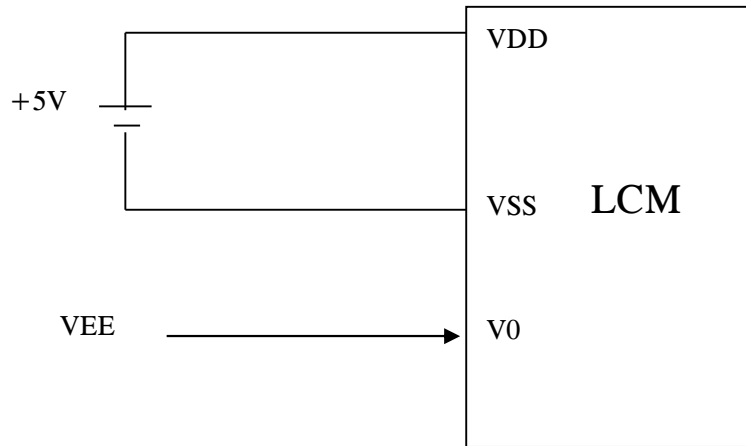

7 PCB DRAWING AND DESCRIPTION

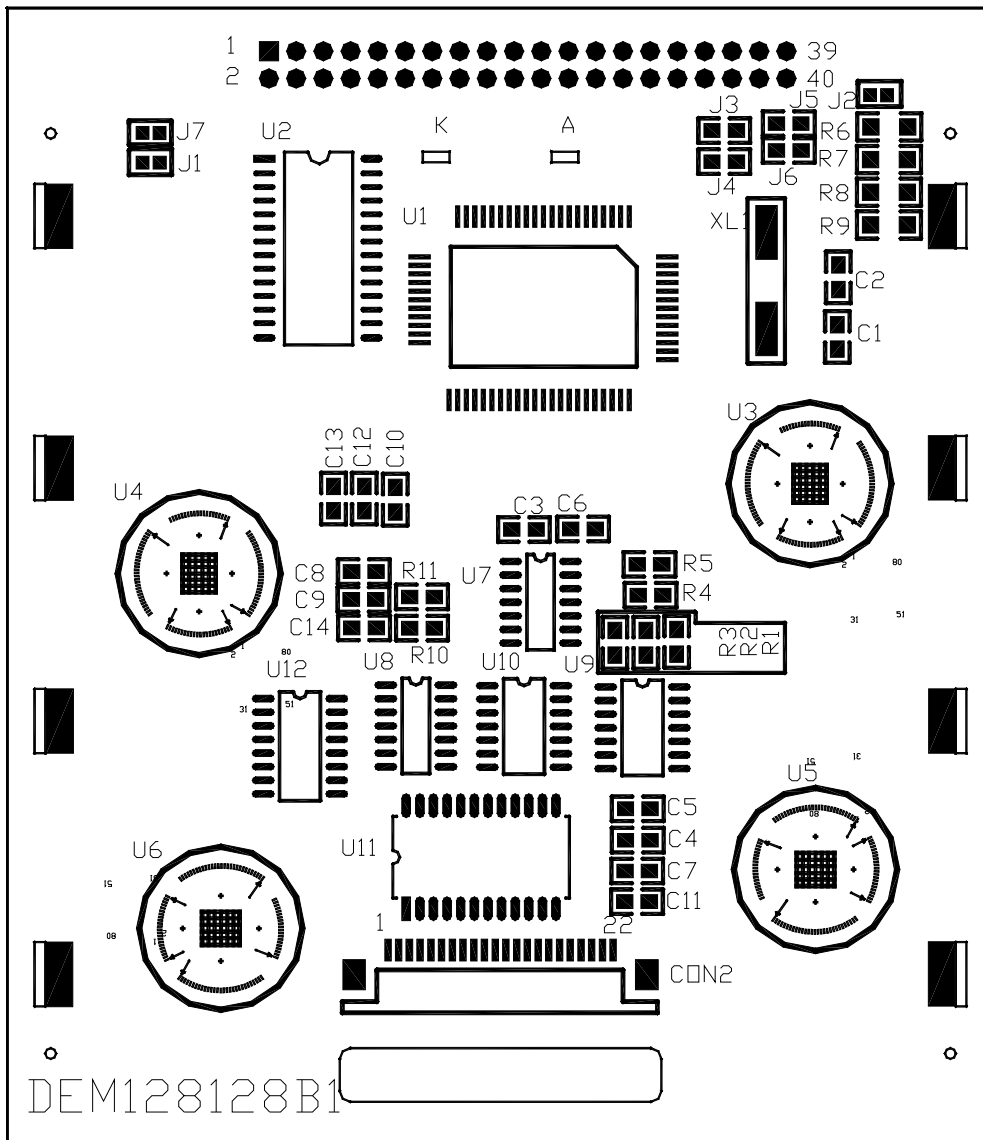

Note: It is only a draft drawing to show the components on the PCB. We should update the drawing after the PCB sample is approved.

**7.1 DESCRIPTION:**

**7-1-1. The polarity of the pin 37 and the pin 39:**

J3, J5	J6, J4	LED Polarity	
		37 Pin	39 Pin
Each closed	Each open	Anode	Cathode
Each open	Each closed	Cathode	Anode

Note: In application module, J3=J5 =closed, J4=J6=J2= open.

**7-1-2. The J1 is metal-bezel GND to module GND and J7 is mounting holes GND to module GND.**

Note: In application module, J1=closed, J7=closed

**7-1-3. The LED resistor should be bridged when J2 is closed**

Note: In application module, J2= open

**7-1-4. The R6 and the R7, R8, R9 are the LED resistor.**

Note: In application module, R6= 47 Ohm, R7=68 Ohm, R8=82 Ohm, R9=open.

**7.2 EXAMPLE APPLICATION**

**7-2-1. The LED resistor should be bridged as following.**

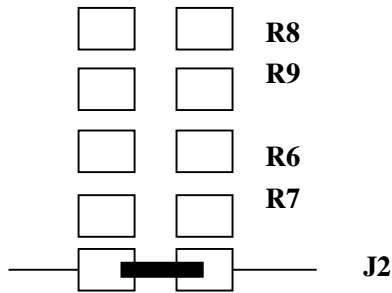

**7-2-2. The 37 pin is the anode and the 39 pin is the cathode as following.**



**7-2-3. The 37 pin is the cathode and the 39 pin is the anode as following.**



**7-2-4. The metal-bezel is on ground as following.**



**7-2-5. The holes is on ground as following**





**8. ABSOLUTE MAXIMUM RATINGS (V<sub>SS</sub>=0V, T<sub>a</sub>=25°C)**

PARAMETER	SYMBOL	RATING	UNIT
Supply Voltage (Logic)	V <sub>DD</sub>	-0.3 to 7.0	V
Input Voltage	V <sub>IN</sub>	-0.3 to V <sub>DD</sub> +0.3	V
Operating Temperature	T <sub>opr</sub>	-20 to +70	°C
Storage Temperature	T <sub>stg</sub>	-25to +75	°C

**9. COMMAMD DEFINITIONS**

No.	Command	C/D	W/R	D7	D6	D5	D4	D3	D2	D1	D0	Action	Value
1.	Set Cursor Pointer	1	0	0	0	1	0	0	0	0	1		21h
		0	0	#	#	#	#	#	#	#	#	Set X address	
		0	0	#	#	#	#	#	#	#	#	Set Y address	
2.	Set Offset Register	1	0	0	0	1	0	0	0	1	0		22h
		0	0	#	#	#	#	#	#	#	#	Data	
		0	0	0	0	0	0	0	0	0	0	0	
3.	Set Address Pointer	1	0	0	0	1	0	0	1	0	0		24h
		0	0	#	#	#	#	#	#	#	#	Low address	
		0	0	#	#	#	#	#	#	#	#	High address	
4.	Set Text Home Addr.	1	0	0	1	0	0	0	0	0	0		40h
		0	0	#	#	#	#	#	#	#	#	Low address	
		0	0	#	#	#	#	#	#	#	#	High address	
5.	Set Text Area	1	0	0	1	0	0	0	0	0	1		41h
		0	0	#	#	#	#	#	#	#	#	Columns	
		0	0	0	0	0	0	0	0	0	0	0	
6.	Set Graphic Home Addr.	1	0	0	1	0	0	0	0	1	0		42h
		0	0	#	#	#	#	#	#	#	#	Low address	
		0	0	#	#	#	#	#	#	#	#	High address	
7.	Set Graphic Area	1	0	0	1	0	0	0	0	1	1		43h
		0	0	#	#	#	#	#	#	#	#	Columns	
		0	0	0	0	0	0	0	0	0	0	0	
8.	OR mode	1	0	1	0	0	0	-	0	0	0		8xh
9.	EXOR mode	1	0	1	0	0	0	-	0	0	1		
10.	AND mode	1	0	1	0	0	0	-	0	1	1		
11.	Text Attribute mode	1	0	1	0	0	0	-	1	0	0		
0	0	-	-	-	-	#	#	#	#				
12.	Internal CG ROM mode	1	0	1	0	0	0	0	-	-	-		
13.	External CG RAM mode	1	0	1	0	0	0	1	-	-	-		
14.	Display Mode	1	0	1	0	0	1	#	#	#	#	Switch Graphic/Text/Cursor/Blink ON/OFF	9xh
15.	Cursor Pattern Select	1	0	1	0	1	0	0	#	#	#	Set cursor: 1~8-line	Axh
16.	Data-write and Increase ADP	1	0	1	1	0	0	0	0	0	0		C0h
		0	0	#	#	#	#	#	#	#	#	Data	
17.	Data-read and Increase ADP	1	1	1	1	0	0	0	0	0	1		C1h
18.	Data-write and Decrease ADP	1	0	1	1	0	0	0	0	1	0		C2h
		0	0	#	#	#	#	#	#	#	#	Data	
19.	Data-read and Decrease ADP	1	1	1	1	0	0	0	0	1	1		C3h
20.	Data-write and Non-variable ADP	1	0	1	1	0	0	0	1	0	0		C4h
		0	0	#	#	#	#	#	#	#	#	Data	
21.	Data-read and Non-variable ADP	1	1	1	1	0	0	0	1	0	1		C5h
22.	Set Data Auto Write	1	0	1	0	1	1	0	0	0	0		B0h
23.	Set Data Auto Read	1	0	1	0	1	1	0	0	0	1		B1h
24.	Auto Reset	1	0	1	0	1	1	0	0	1	0		B2h
25.	Screen Peek	1	0	1	1	1	0	0	0	0	0		E0h
26.	Screen Copy	1	0	1	1	1	0	1	0	0	0		E8h
27.	Bit Set/Reset	1	0	1	1	1	1	#	#	#	#	Set/Reset Bit 0~7	Fxh
28.	Whole Screen Reverse (Triple-byte command)	1	0	1	1	0	1	0	0	0	0		D0h
		0	0	-	-	-	-	-	-	-	#	0: Normal      1: Reverse	
		0	0	-	-	-	-	-	-	-	-	(Don't Care)	

No.	Command	C/D	W/R	D7	D6	D5	D4	D3	D2	D1	D0	Action	Value
29.	Blink Time (Triple-byte command)	1	0	0	1	0	1	0	0	0	0		50h
		0	0	-	-	-	-	-	#	#	#	000b: 0.066s    100b: 1s 001b: 0.25s    101b: 1.25s 010b: 0.5s      110b: 1.5s 011b: 1.75s    111b: 2s	010b
		0	0	-	-	-	-	-	-	-	-	-	(Don't Care)
30.	Cursor Auto Moving (Triple-byte command)	1	0	0	1	1	0	0	0	0	0		60h
		0	0	-	-	-	-	-	-	-	#	0: disable      1: enable	
		0	0	-	-	-	-	-	-	-	-	-	(Don't Care)
31.	CGROM Font Select (Triple-byte command)	1	0	0	1	1	1	0	0	0	0		70h
		0	0	-	-	-	-	-	-	#	#	00b: Don't care 01b: Don't care 10b: CGROM Font-01 11b: CGROM Font-02	
		0	0	-	-	-	-	-	-	-	-	-	(Don't Care)

10. ELECTRICAL CHARACTERISTICS

10.1 DC Characteristics

Parameter	Symbol	Conditions	Min.	Typ.	Max.	Units
Supply Voltage (Logic)	V <sub>DD</sub>	-	4.7	5.0	5.3	V
High Level Input Voltage	V <sub>IH</sub>	-	0.8V <sub>DD</sub>	-	V <sub>DD</sub>	V
Low Level Input Voltage	V <sub>IL</sub>	-	0	-	0.2 V <sub>DD</sub>	V
High Level Output Voltage	V <sub>OH</sub>		V <sub>DD</sub> -0.3	-	V <sub>DD</sub>	V
Low Level Output Voltage	V <sub>OL</sub>		0	-	0.3	V
Current Consumption(Operating)	I <sub>DD(1)</sub>	V <sub>DD</sub> =5.0V f <sub>OSC</sub> = 4.0 MHz	-	3.0	5	mA
Current Consumption(Halt)	I <sub>DD(2)</sub>	V <sub>DD</sub> =5.0V		1	2	uA

10.2 AC Characteristics

Parameter	Symbol	Min.	Max.	Units
C/D Setup Time	t <sub>CDS</sub>	100	-	ns
C/D Hold Time	t <sub>CDH</sub>	10	-	ns
CE, RD, WR Pulse Width	t <sub>CE</sub> , t <sub>RD</sub> , t <sub>WR</sub>	80	-	ns
Data Setup Time	t <sub>DS</sub>	80	-	ns
Data Hold Time	t <sub>DH</sub>	40	-	ns
Access Time	t <sub>ACC</sub>	-	150	ns
Output Hold Time	t <sub>OH</sub>	10	50	ns

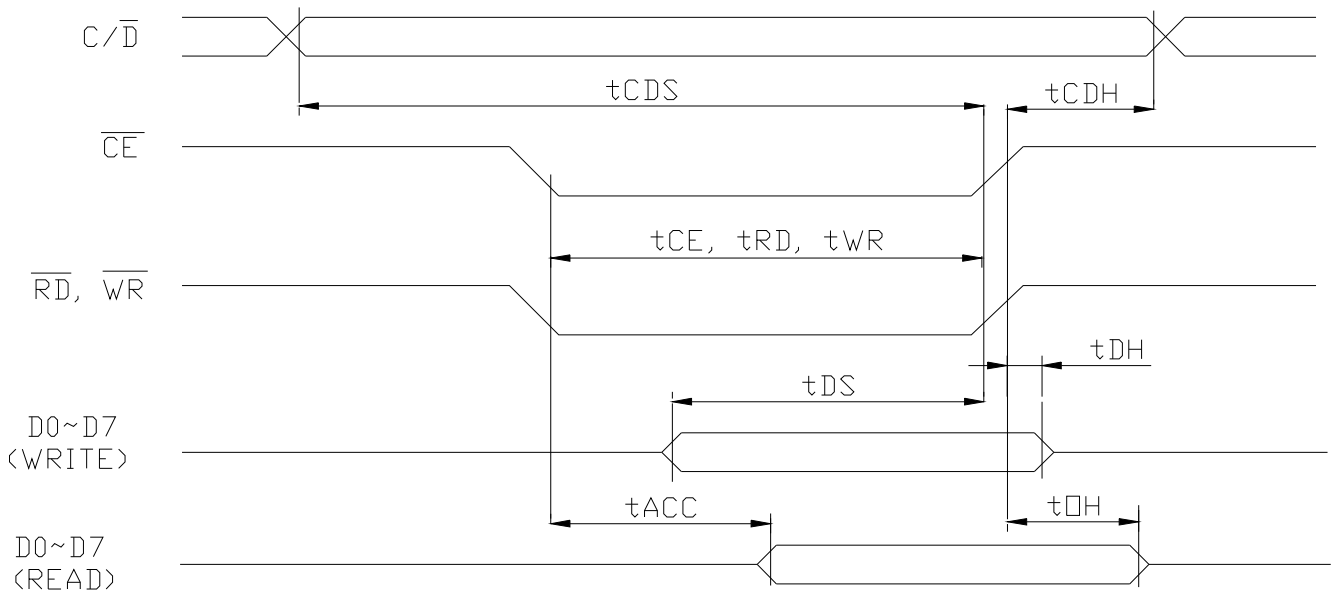

**10.3 Power Supply ON/OFF Sequence**

**ON Sequence**

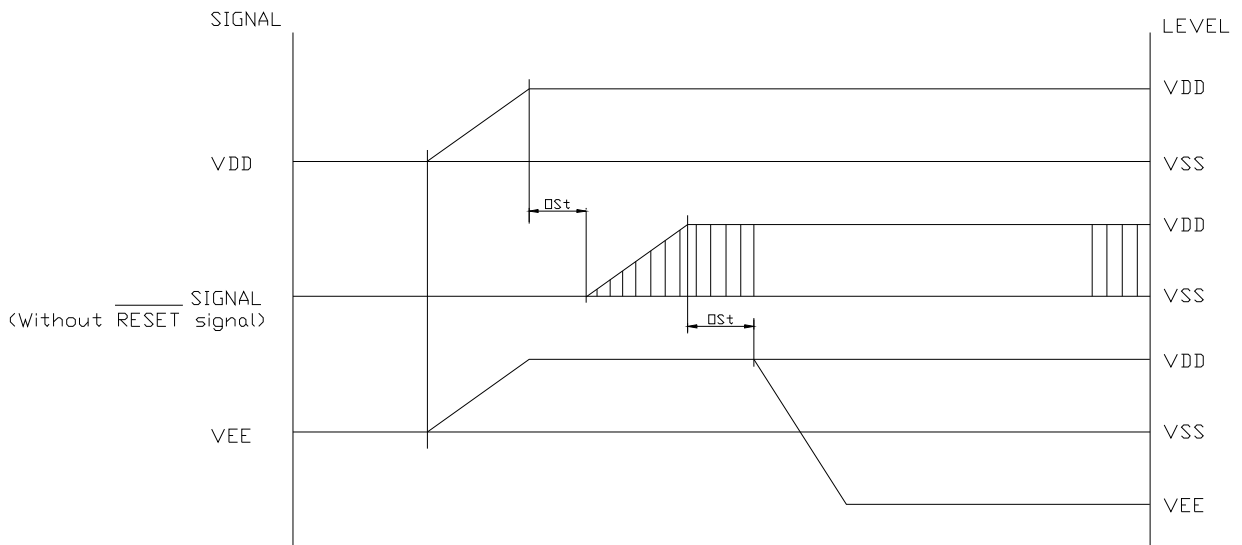

**OFF Sequence**

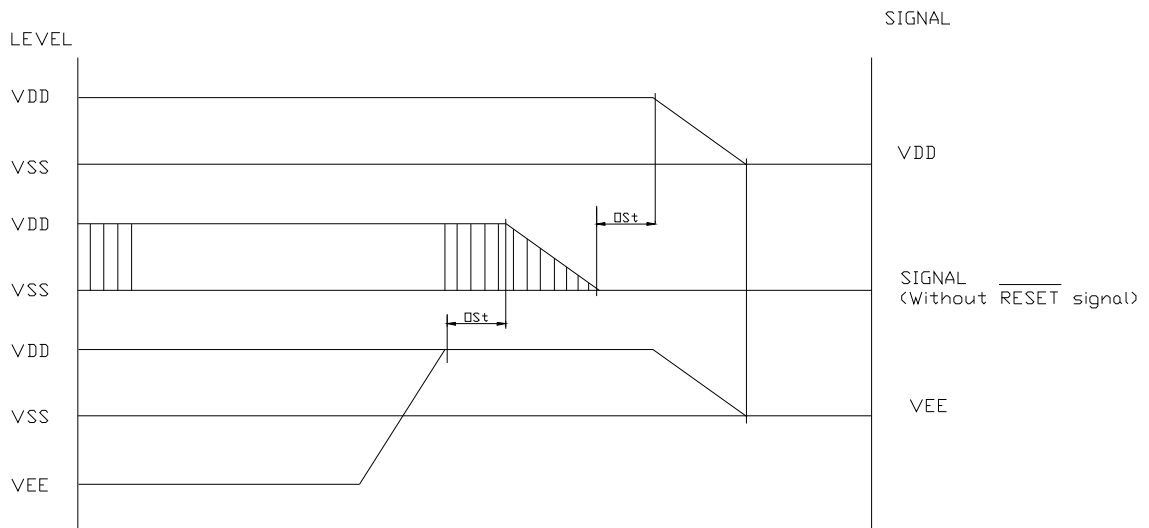

**Reset Sequence**

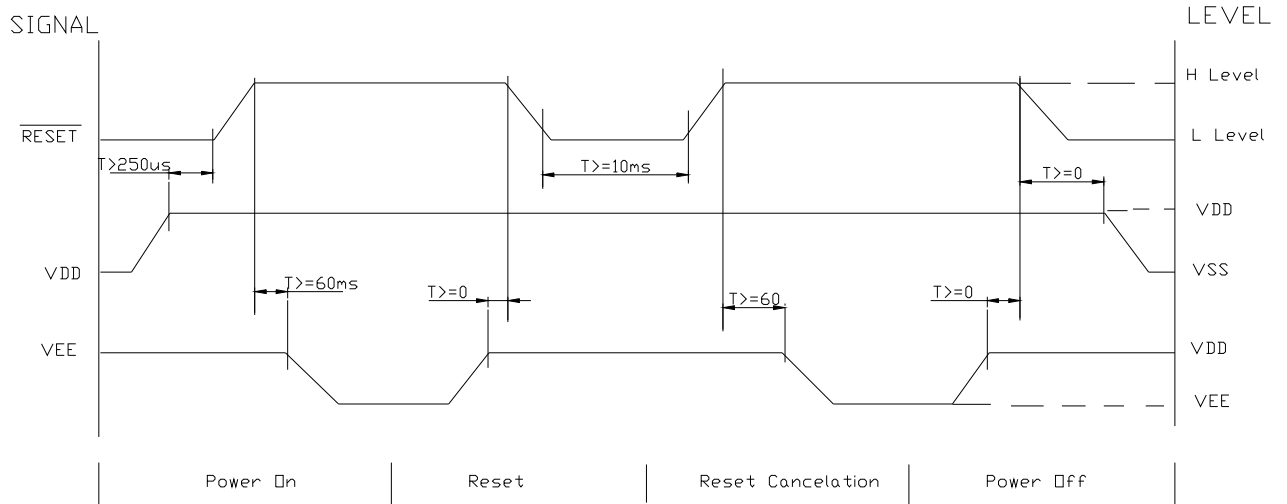

Please maintain the above sequence when turning on and off the power supply of the module.

If VEE is supplied to the module while internal alternate signal for LCD driving (M) is unstable or RESET is active, DC component will be supplied to the LCD panel. This may cause damage to the LCD module.

**11. BACKLIGHT ELECTRICAL/OPTICAL SPECIFICATIONS**

**ELECTRICAL–OPTICAL CHARACTERISTICS**

Item	Symbol	min.	typ.	max.	Unit	Condition
Forward Voltage	Vf	2.9	3.2	3.5	V	If= 105 mA
Reverse Current	Ir		30		$\mu A$	Vr= 0.8 V
Chromaticity Uniformity		65	75			
Spectral Line Half width	$\Delta\lambda$				nm	If= mA
Luminance	Lv	175	250		cd/m <sup>2</sup>	If= 105 mA
Operating Temperature Range	Topr				-30~+70	°C
Storage Temperature Range	Tstg				-40~+80	°C

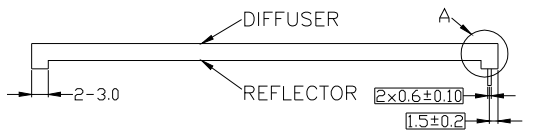
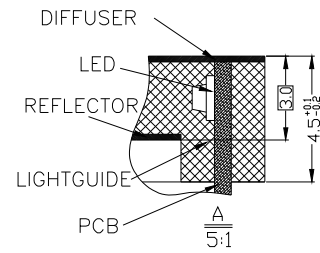
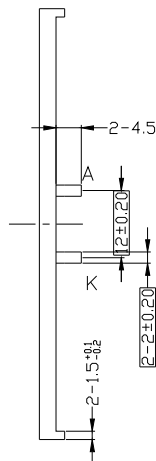
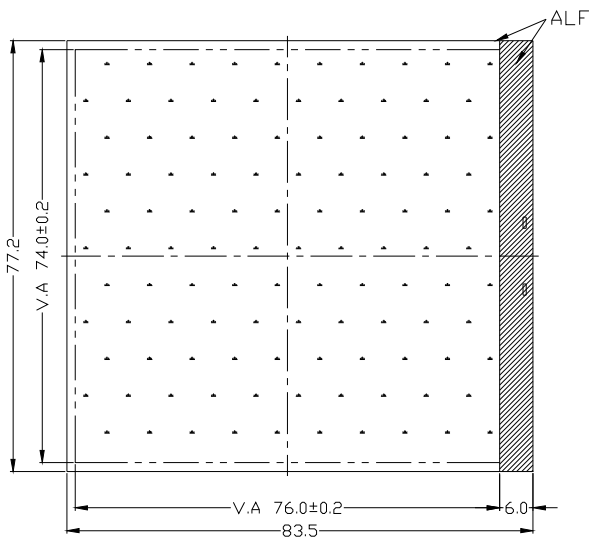

**CHROMATICS COORDINATES**

x	0.296	0.287	0.330	0.330
y	0.276	0.295	0.339	0.318

TOLERANCE IS ±0.01

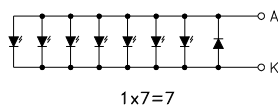
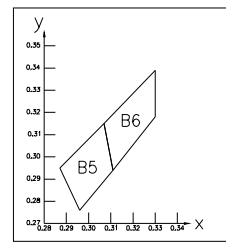

**Remarks:**

- 1, Unmarked tolerance is ±0.3;
- 2, The color is white;
- 3, All material is lead-free

**12. QUALITY DESCRIPTION**

DEFECT SPECIFICATION:

Specific type-related items are covered in this sheet.

- a: Table for Cosmetic defects  
(Note: nc = not counted).  
Sizes and number of defects  
(Max. Qty)

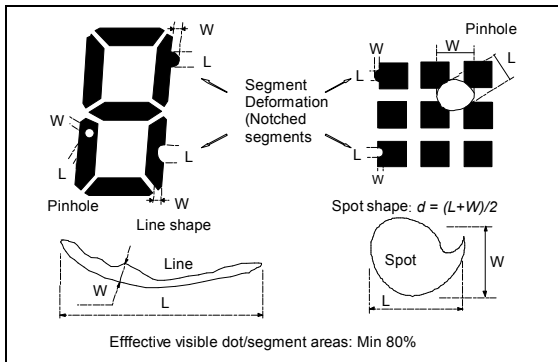

Shapes

- b: Glass defects
- b1: Glass defects at contact ledge

b2: Glass chipping in other areas shall not be in conflict with the product's function.

Defect Type	Max. defect size [ $\mu\text{m}$ ] d or L W	Max. Quantity
Black or White Spots	$d \leq 150$	nc
	$150 < d \leq 300$	5
Black or White Lines	-- $W \leq 10$	nc
	$L \leq 5000$ $W \leq 30$	3
	$L \leq 2000$ $W \leq 50$	2
Pinhole	$d \leq 150$	nc
	$150 < d \leq 300$	1/segment
(Total defects)		(5)
Segment Deformation	$W \leq 100$	nc
Bubble (e.g. under pola)	$d \leq 150$	nc
	$200 < d \leq 400$	3
	$400 < d \leq 600$	1

Examples/

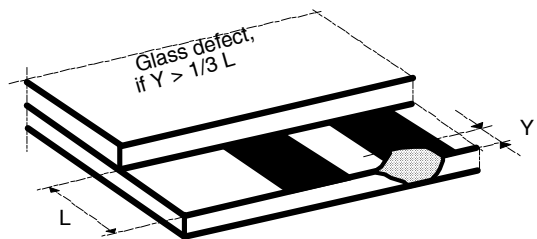

**13. MODULE ACCEPT QUALITY LEVEL (AQL)**

13.1 AQL Standard Value: Fatal Defect =0.1, Major Defect=0.65; Minor Defect =2.5.

13.2 Curtailed Inspection Scheme

Type	Batch Qty	inspection Qty	AQL value	pass	Reject
module product	350PCS < 1000PCS	125pcs	0.1	0	1
			0.65	2	3
			2.5	7	8
	200PCS < 350PCS	80pcs	0.1	0	1
			0.65	1	2
			2.5	5	6
	<200PCS	32pcs	0.1	0	1
			0.65	0	1
			2.5	4	5
Module sample	<200PCS	All inspected	/	/	The sample will be reject when the fatal defect>2pcs or main defect>5pcs.
	>200PCS	125pcs			

- Notes:**
- 1). Batch QTY is the production amount that Production department ship to QA department.
  - 2). All of product will be inspected if the batch QTY less than inspected QTY.
  - 3). Each batch fixed to be 500pcs.

**14. RELIABILITY TEST**

Operating life time: Longer than 50000 hours (at room temperature without direct irradiation of sunlight)

Reliability characteristics shall meet following requirements.

TEMPERATURE TESTS	NORMAL GRADE
High Temperature Storage	+75°C *96hrs
Low Temperature Storage	-25°C * 96hrs
High Temperature Operation	+70°C *96hrs
Low Temperature Operation	-20°C *96hrs
High Temperature, High Humidity	+70°C* 95%RH *96hrs
Thermal Shock	-20°C *30min. ← 10s ↓ 5Cycles +70°C *30min. —
Vibration Test	Frequency *Swing * Time 40Hz * 4mm * 4hrs
Drop Test	Drop height*Times 1.0m * 6times

**15. LCD MODULES HANDLING PRECAUTIONS**

- Please remove the protection foil of polarizer before using.
- The display panel is made of glass. Do not subject it to a mechanical shock by dropping it from a high place, etc.
- If the display panel is damaged and the liquid crystal substance inside it leaks out, do not get any in your mouth. If the substance come into contact with your skin or clothes promptly wash it off using soap and water.
- Do not apply excessive force to the display surface or the adjoining areas since this may cause the color tone to vary.
- The polarizer covering the display surface of the LCD module is soft and easily scratched. Handle this polarize carefully.
- To prevent destruction of the elements by static electricity, be careful to maintain an optimum work environment.
  - Be sure to ground the body when handling the LCD module.
  - Tools required for assembly, such as soldering irons, must be properly grounded.
  - To reduce the amount of static electricity generated, do not conduct assembly and other work under dry conditions.
  - The LCD module is coated with a film to protect the display surface. Exercise care when peeling off this protective film since static electricity may be generated.
- Storage precautions  
When storing the LCD modules, avoid exposure to direct sunlight or to the light of fluorescent lamps. Keep the modules in bags designed to prevent static electricity charging under low temperature / normal humidity conditions (avoid high temperature / high humidity and low temperatures below 0°C). Whenever possible, the LCD modules should be stored in the same conditions in which they were shipped from our company.

**16. OTHERS**

- Liquid crystals solidify at low temperature (below the storage temperature range) leading to defective orientation of liquid crystal or the generation of air bubbles (black or white). Air bubbles may also be generated if the module is subjected to a strong shock at a low temperature.
- If the LCD modules have been operating for a long time showing the same display patterns may remain on the screen as ghost images and a slight contrast irregularity may also appear. Abnormal operating status can be resumed to be normal condition by suspending use for some time. It should be noted that this phenomena does not adversely affect performance reliability.
- To minimize the performance degradation of the LCD modules resulting from caused by static electricity, etc. exercise care to avoid holding the following sections when handling the modules:
  - Exposed area of the printed circuit board
  - Terminal electrode sections