

Display Elektronik GmbH

DATA SHEET

LCD MODULE

DEM 20233 SYH-LY

Product Specification

Version: 2.1.6.2

19.02.2019

GENERAL SPECIFICATION

MODULE NO. :

DEM 20233 SYH-LY

CUSTOMER P/N

VERSION NO.	CHANGE DESCRIPTION	DATE
0	Original Version	25.07.2006
1	Change IC (SPLC780D1-001A)	16.01.2008
2	Correct Operating Voltage	21.04.2010
2.1.3	Correct IC Datasheet	28.04.2010
2.1.4	Change IC (AIP31066L-001)	03.08.2017
2.1.5	Correct Electro-Optical Characteristics	10.08.2017
2.1.6.0	Change IC (ST7066) and Production Line	06.12.2018
2.1.6.1	Update the Module Drawing; Correct the VLCD to 3,8V; Correct the Block Diagram as 2x20; Correct the BL Voltage	13.12.2018
2.1.6.2	Add PCD Drawing	19.02.2019

PREPARED BY: PS DATE: 19.02.2019

APPROVED BY: MHI DATE: 19.02.2019

CONTENTS

1. FUNCTIONS & FEATURES 4

2. MECHANICAL SPECIFICATIONS..... 4

3. BLOCK DIAGRAM..... 4

4. EXTERNAL DIMENSIONS 5

5. PIN DESCRIPTION..... 6

6. PCB DRAWING AND DESCRIPTION..... 6

7. BACKLIGHT ELECTRICAL/OPTICAL SPECIFCATIONS..... 7

8. MAXIMUM ABSOLUTE POWER RATINGS 8

9. ELECTRICAL CHARACTERISTICS 8

10. CONTOL AND DISPLAY COMMAND 11

12. ELECTRO-OPTICAL DEFINITION 13

13. QUALITY DESCRIPTION..... 15

14. RELIABILITY TEST..... 16

15. LCD MODULES HANDLING PRECAUTIONS 16

16. OTHERS 17

1. FUNCTIONS & FEATURES

I DEM 20233 SYH-LY Series LCD Type :

MODULE	LCD TYPE	REMARK
DEM 20233 SYH-LY	STN Yellow-Green Transflective Positive Mode	

- I Display Format : 20 x 2 Characters
- I Viewing Direction : 6 O'clock
- I Driving Scheme : 1/16 Duty Cycle, 1/5 Bias
- I Power Supply Voltage(V_{DD}) : 5.0 Volt (typ)
- I LCD Driver voltage(V_{LCD}) : 3.8 Volt (typ)
- I Backlight Color : LED, Array, Yellow-Green(116 x LEDs)

2. MECHANICAL SPECIFICATIONS

- I Module Size : 180.00 x 40.00 x 13.90 mm
- I Viewing Area : 149.00 x 23.00 mm
- I Active Area : 142.80 x 20.64 mm
- I Character Pitch : 7.20 x 10.98 mm
- I Character Size : 6.00 x 9.66 mm
- I Dot Pitch : 1.22 x 1.22 mm
- I Dot Size : 1.12 x 1.12 mm

3. BLOCK DIAGRAM

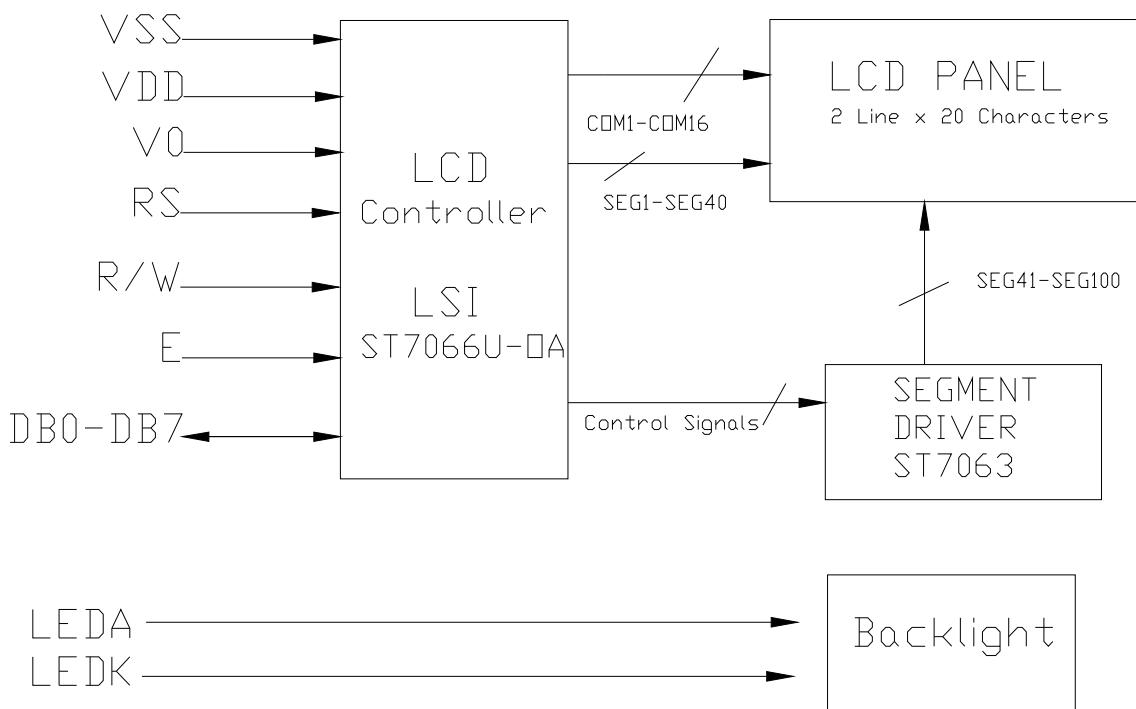

4. EXTERNAL DIMENSIONS

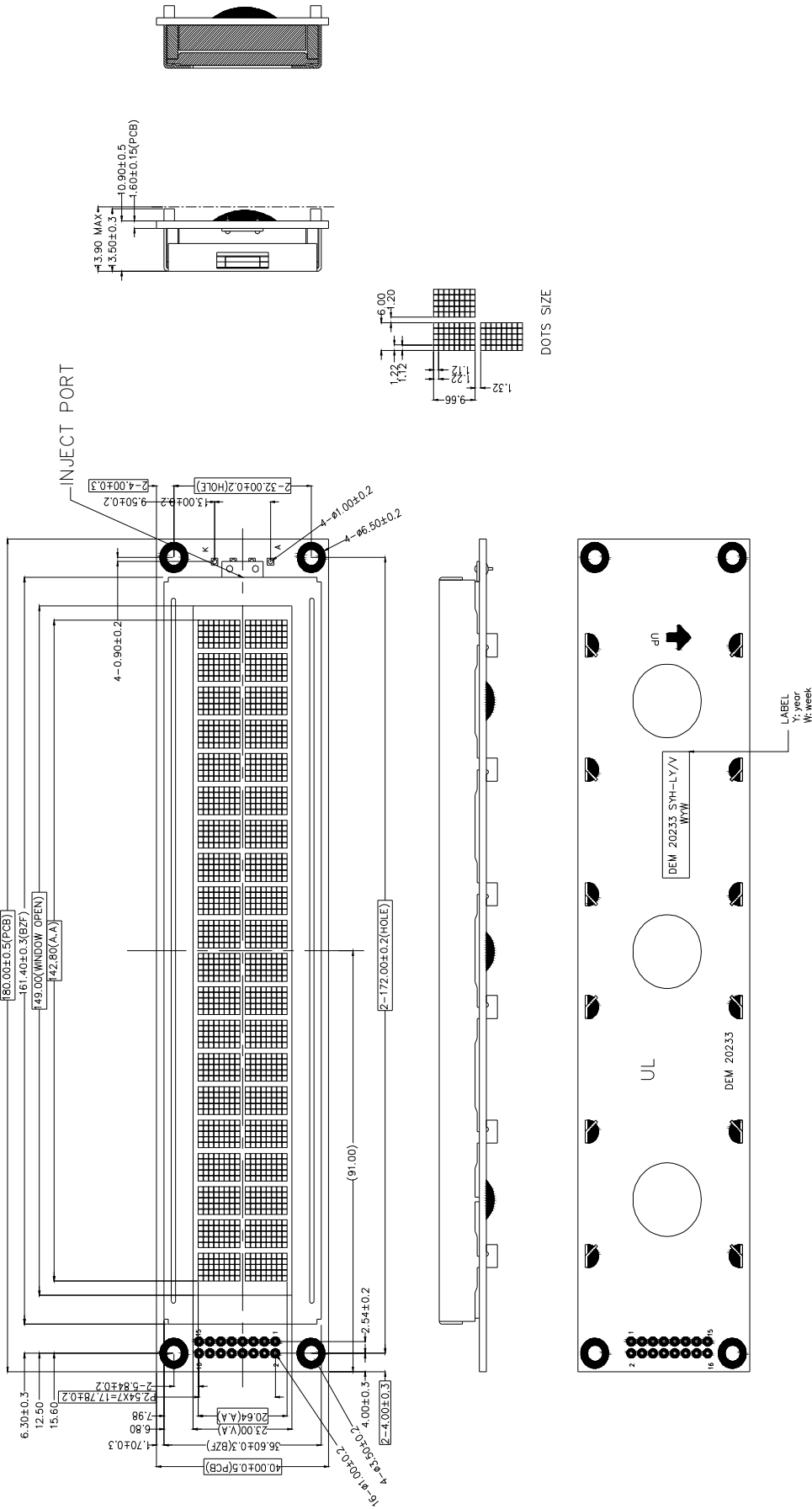

Remarks:

- 1. Unmarked tolerance is ±0.3
- 2. All materials comply with RoHS
- 3. □: critical dimension.

CONSTANT VOLTAGE: 5.0V, ≤580mA
 BACKLIGHT DRIVER CIRCUIT DIAGRAM

5. PIN DESCRIPTION

Pin No.	Symbol	Function
1	Vss	Ground of Chip(0V)
2	VDD	Power Supply(+5V)
3	V0	Power Supply for LCD Driver
4	RS	Registers Selection (H:Data register,L:Instruction register)
5	R/W	Read/ Write Selection (H: Read L: Write)
6	E	Enable Signal for LCM
7~14	DB0~DB7	Data Bus Lines
15	LED+(A)	Power Supply for Backlight (Voltage +5.0V,Current < 580mA)
16	LED-(K)	Power Supply for Backlight (0V)

6. PCB DRAWING AND DESCRIPTION

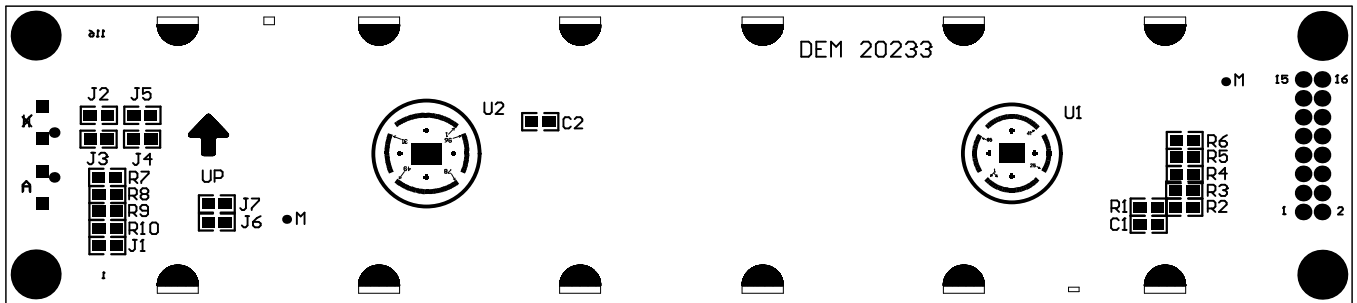

DESCRIPTION:

6-1-1. The polarity of the pin 15 and the pin 16:

J3.J5	J2.J4	LED Polarity	
		15 Pin	16 Pin
Each Open	Each Closed	Anode	Cathode
Each Closed	Each Open	Cathode	Anode

In application module, J2= J4= closed and J3= J5= open

6-1-2. The metal-bezel is set be ground when the J6 is closed

In application module, J6= closed

6-1-3. The LED resistor should be bridged when the J1 is open

In application module, J1= open

6-1-4. The mounting-hole is set be ground when the J7 is closed

In application module, J7= closed

6-1-5. The R7, the R8, the R9 and the R10 are the LED resistor.

In application module, R7= 10 Ohm, R8= 10 Ohm, R9= 10 Ohm R10= 10 Ohm

7. BACKLIGHT ELECTRICAL/OPTICAL SPECIFICATIONS

Item	Symbol	MIN.	TYP.	MAX.	Unit	Condition
Forward Voltage	Vf	4	4.4	4.8	V	T=25°C If= 580 mA
Reverse Current	IR	-	-	10	uA	
Wave length (Without LCD)	λ_p	569	572	575	nm	
Luminance(Without LCD)	Lv	165	220	/	cd/m ²	
Uniformity	Avg	70			%	
Color	Bottom YG					



Remarks:

- 1.Unmarked tolerance is ±0.3
- 2.All materials comply with RoHs
3. .:critical dimension.

8. MAXIMUM ABSOLUTE POWER RATINGS

Item	Symbol	Min	Max	Unit
Power Supply Voltage	V _{DD}	-0.3	6.0	V
LCD Driver Voltage	V _{LCD}	V _{DD} -10.0	V _{DD} +0.3	V
Input Voltage	V _{in}	-0.3	V _{DD} +0.3	V
Operating Temperature	T _{op}	-20	+70	□
Storage Temperature	T _{st}	-30	+80	□

9. ELECTRICAL CHARACTERISTICS

9-1. DC Characteristics

Item	Symbol	Standard Value			Unit
		MIN	TYP	MAX	
Operating Voltage	V _{DD}	4.7	5.0	5.3	V
LCD Voltage	V _{OP}	3.5	3.8	4.1	V
Supply Current	I _{DD}	----	TBD	----	mA

9-2 .AC Characteristics

9-2-1 Write Mode

T _C	Enable Cycle Time	Pin E	1200	-	-	ns
T _{PW}	Enable Pulse Width	Pin E	140	-	-	ns
T _R ,T _F	Enable Rise/Fall Time	Pin E	-	-	25	ns
T _{AS}	Address Setup Time	Pins: RS,RW,E	0	-	-	ns
T _{AH}	Address Hold Time	Pins: RS,RW,E	10	-	-	ns
T _{DSW}	Data Setup Time	Pins: DB0 - DB7	40	-	-	ns
T _H	Data Hold Time	Pins: DB0 - DB7	10	-	-	ns

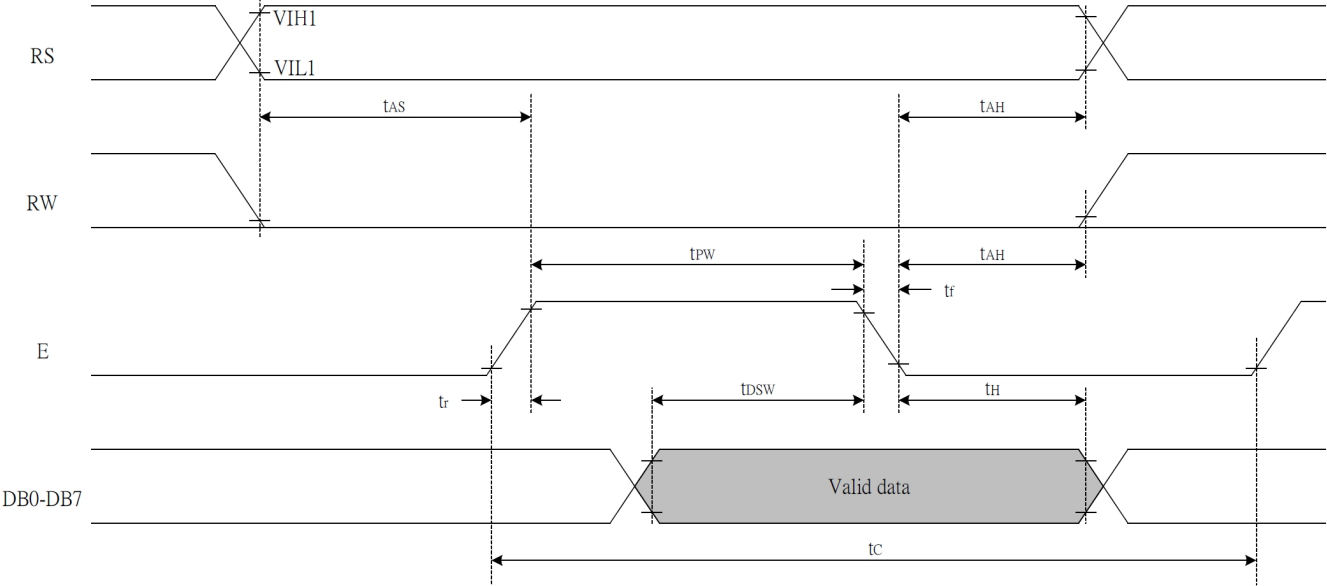

9-2-2 Read Mode

T_C	Enable Cycle Time	Pin E	1200	-	-	ns
T_{PW}	Enable Pulse Width	Pin E	140	-	-	ns
T_R, T_F	Enable Rise/Fall Time	Pin E	-	-	25	ns
T_{AS}	Address Setup Time	Pins: RS,RW,E	0	-	-	ns
T_{AH}	Address Hold Time	Pins: RS,RW,E	10	-	-	ns
T_{DDR}	Data Setup Time	Pins: DB0 - DB7	-	-	100	ns
T_H	Data Hold Time	Pins: DB0 - DB7	10	-	-	ns

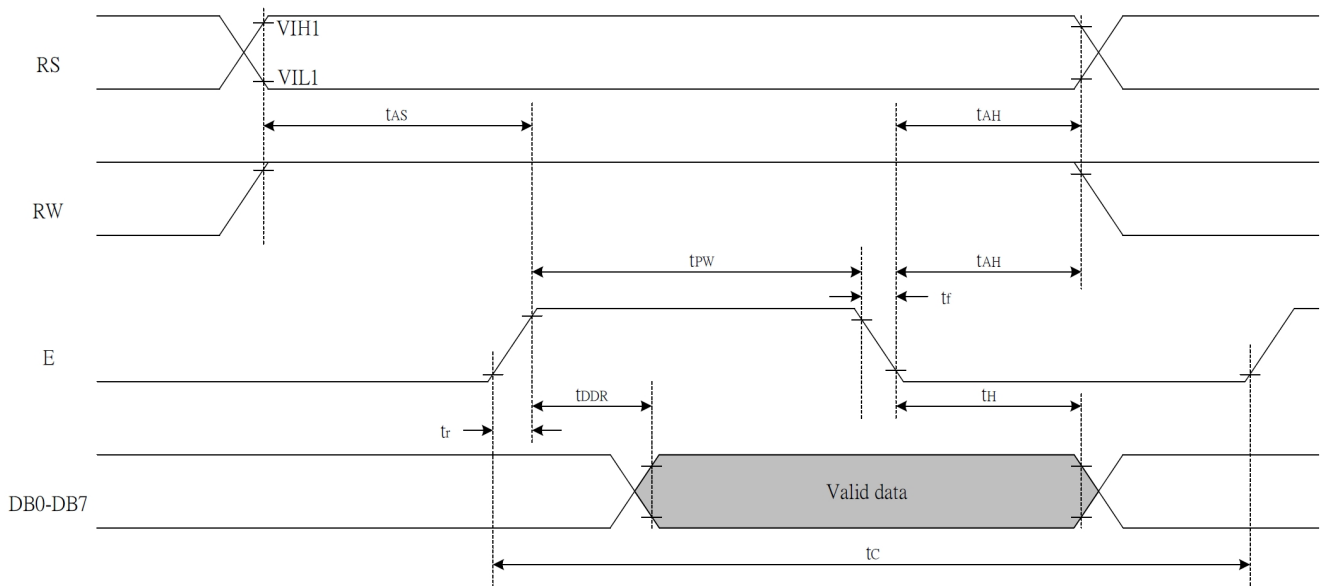

10. CONTOL AND DISPLAY COMMAND

There are four categories of instructions that:

- I Designate ST7066U functions, such as display format, data length, etc.
- I Set internal RAM addresses
- I Perform data transfer with internal RAM
- I Others

Instruction	Instruction Code										Description	Description Time (270KHz)	
	RS	R/W	DB7	DB6	DB5	DB4	DB3	DB2	DB1	DB0			
Clear Display	0	0	0	0	0	0	0	0	0	0	1	Write "20H" to DDRAM. and set DDRAM address to "00H" from AC	1.52 ms
Return Home	0	0	0	0	0	0	0	0	0	1	x	Set DDRAM address to "00H" from AC and return cursor to its original position if shifted. The contents of DDRAM are not changed.	1.52 ms
Entry Mode Set	0	0	0	0	0	0	0	0	1	I/D	S	Sets cursor move direction and specifies display shift. These operations are performed during data write and read.	37 us
Display ON/OFF	0	0	0	0	0	0	0	1	D	C	B	D=1:entire display on C=1:cursor on B=1:cursor position on	37 us
Cursor or Display Shift	0	0	0	0	0	0	1	S/C	R/L	x	x	Set cursor moving and display shift control bit, and the direction, without changing DDRAM data.	37 us
Function Set	0	0	0	0	1	DL	N	F	x	x		DL:interface data is 8/4 bits N:number of line is 2/1 F:font size is 5x11/5x8	37 us
Set CGRAM address	0	0	0	1	AC5	AC4	AC3	AC2	AC1	AC0		Set CGRAM address in address counter	37 us
Set DDRAM address	0	0	1	AC6	AC5	AC4	AC3	AC2	AC1	AC0		Set DDRAM address in address counter	37 us
Read Busy flag and address	0	1	BF	AC6	AC5	AC4	AC3	AC2	AC1	AC0		Whether during internal operation or not can be known by reading BF. The contents of address counter can also be read.	0 us
Write data to RAM	1	0	D7	D6	D5	D4	D3	D2	D1	D0		Write data into internal RAM (DDRAM/CGRAM)	37 us
Read data from RAM	1	1	D7	D6	D5	D4	D3	D2	D1	D0		Read data from internal RAM (DDRAM/CGRAM)	37 us

Note:

Be sure the ST7066U is not in the busy state (BF = 0) before sending an instruction from the MPU to the ST7066U. If an instruction is sent without checking the busy flag, the time between the first instruction and next instruction will take much longer than the instruction time itself. Refer to Instruction Table for the list of each instruction execution time.

11. STANDARD CHARACTER PATTERN (ST7066U-0A)

Upper8bit																	
Lower8bit		0000	0001	0010	0011	0100	0101	0110	0111	1000	1001	10010	1011	1100	1101	1110	1111
0000	CG RAM (1)																
0001	(2)																
0010	(3)																
0011	(4)																
0100	(5)																
0101	(6)																
0110	(7)																
0111	(8)																
1000	(1)																
1001	(2)																
1010	(3)																
1011	(4)																
1100	(5)																
1101	(6)																
1110	(7)																
1111	(8)																

12. ELECTRO-OPTICAL DEFINITION

Optical Characteristics

Item	Symbol	Description	Condition	Min	Typ	Max	Unt
Operating Voltage of LCD	V _{OP}	---	T _a = -20°C	3.8	4.0	4.2	V
		---	T _a = 25°C	3.6	3.8	4.0	
		---	T _a = 70°C	3.3	3.5	3.7	
Response Time	T _r	Rise	25°C	---	---	250	ms
	T _f	Fall	25°C	---	---	250	ms
Contrast	Cr		VDD= 5.0V, 25°C	---	3	---	
Viewing Angle	θ	6 o'clock axis	Cr≥2.0 VDD= 5.0V, 25°C	---	35	---	
		12 o'clock axis	VDD= 5.0V, 25°C	---	30	---	
		3 o'clock axis	VDD= 5.0V, 25°C	---	30	---	
		9 o'clock axis	VDD= 5.0V, 25°C	---	30	---	

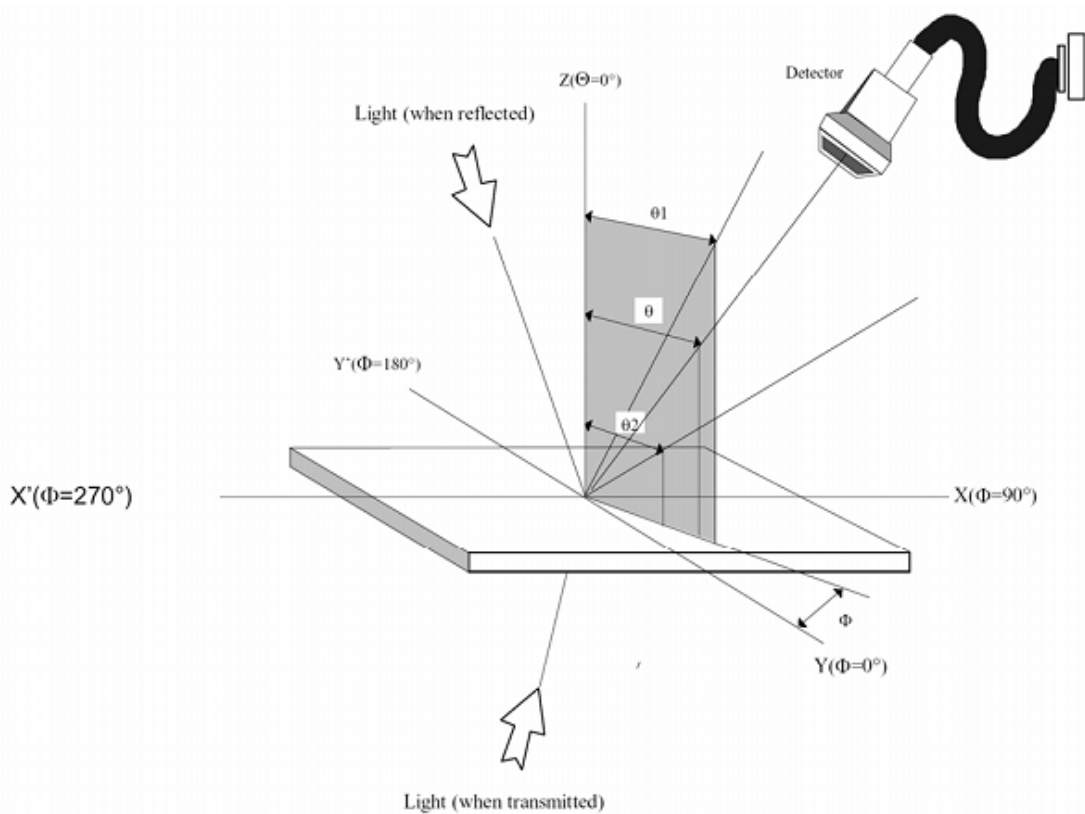

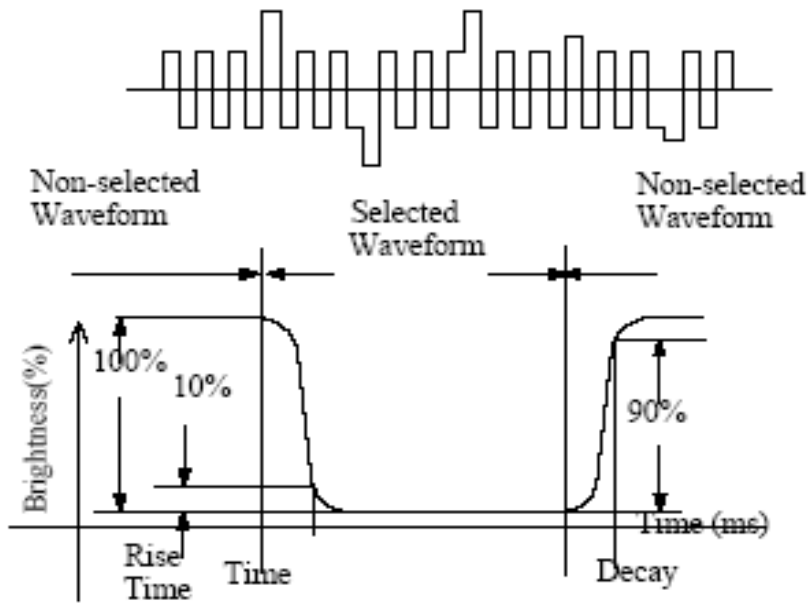

Definition of contrast $Cr. = \frac{B2}{B1} = \frac{\text{Bright curve of not selected segment}}{\text{Bright curve of selected segment}}$

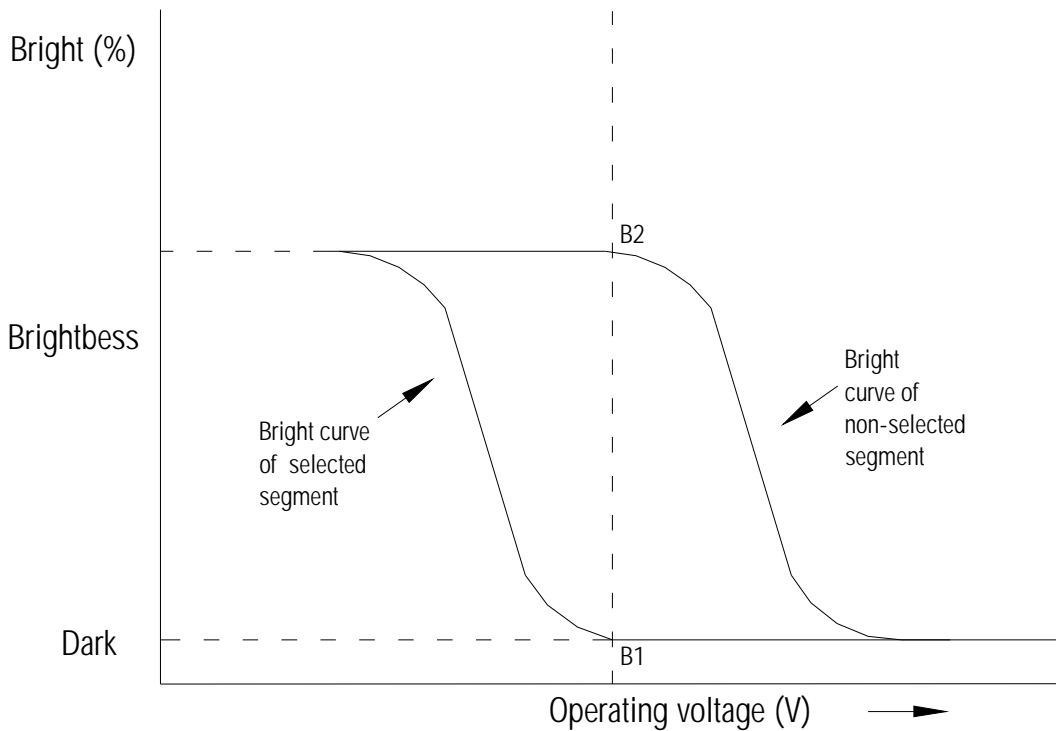

13. QUALITY DESCRIPTION

DEFECT SPECIFICATION:

Specific type-related items are covered in this sheet.

a: Table for Cosmetic defects
 (Note: nc = not counted).
 Sizes and number of defects
 (Max. Qty)

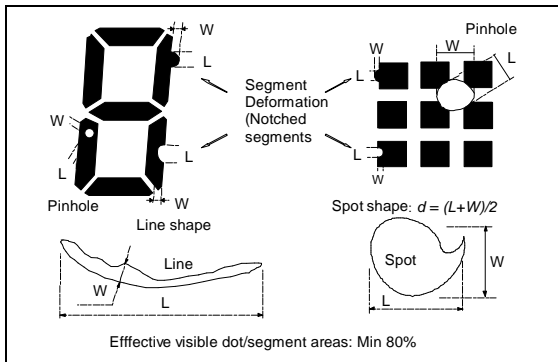

Shapes

b: Glass defects
 b1: Glass defects at contact ledge

b2: Glass chipping in other areas shall not be in conflict with the product's function.

Defect Type	Max. defect size [mm] d or L W	Max. Quantity.
Black or White Spots	$d \leq 100$	nc
	$100 < d \leq 200$	5
Black or White Lines	-- $W \leq 10$	nc
	$L \leq 5000$ $W \leq 30$	3
Pinhole	$L \leq 2000$ $W \leq 50$	2
	$d \leq 100$ $100 < d \leq 200$	nc 1/segment
(Total defects)		(5)
Segment Deformation	$W \leq 100$	nc
Bubble (e.g. under pola)	$d \leq 150$	nc
	$200 < d \leq 400$	3
	$400 < d \leq 600$	1

Examples/

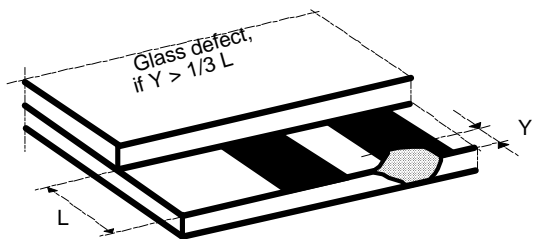

14. RELIABILITY TEST

Operating life time: Longer than 50000 Hours (at room temperature without direct irradiation of sunlight)

Reliability characteristics shall meet following requirements.

TEMPERATURE TESTS	NORMAL GRADE
High Temperature Storage	+80°C *96hrs
Low Temperature Storage	-30°C * 96hrs
High Temperature Operation	+70°C *96hrs
Low Temperature Operation	-20°C *96hrs
High Temperature, High Humidity	+60°C * 95%RH *96hrs
Thermal Shock	-20°C *30min. ← 10s ↓ 5Cycles +70°C *30min. —
Vibration Test	Frequency *Swing * Time 40Hz * 4mm * 4hrs
Drop Test	Drop height*Times 1.0m * 6times

15. LCD MODULES HANDLING PRECAUTIONS

- n Please remove the protection foil of polarizer before using.
- n The display panel is made of glass. Do not subject it to a mechanical shock by dropping it from a high place, etc.
- n If the display panel is damaged and the liquid crystal substance inside it leaks out, do not get any in your mouth. If the substance come into contact with your skin or clothes promptly wash it off using soap and water.
- n Do not apply excessive force to the display surface or the adjoining areas since this may cause the color tone to vary.
- n The polarizer covering the display surface of the LCD module is soft and easily scratched. Handle this polarize carefully.
- n To prevent destruction of the elements by static electricity, be careful to maintain an optimum work environment.
 - Be sure to ground the body when handling the LCD module.
 - Tools required for assembly, such as soldering irons, must be properly grounded.
 - To reduce the amount of static electricity generated, do not conduct assembly and other work under dry conditions.
 - The LCD module is coated with a film to protect the display surface. Exercise care when peeling off this protective film since static electricity may be generated.
- n Storage precautions

When storing the LCD modules, avoid exposure to direct sunlight or to the light of fluorescent lamps. Keep the modules in bags designed to prevent static electricity charging under low temperature / normal humidity conditions (avoid high temperature / high humidity and low temperatures below 0°C).Whenever possible, the LCD modules should be stored in the same conditions in which they were shipped from our company.

16. OTHERS

- n** Liquid crystals solidify at low temperature (below the storage temperature range) leading to defective orientation of liquid crystal or the generation of air bubbles (black or white). Air bubbles may also be generated if the module is subjected to a strong shock at a low temperature.

- n** If the LCD modules have been operating for a long time showing the same display patterns may remain on the screen as ghost images and a slight contrast irregularity may also appear. Abnormal operating status can be resumed to be normal condition by suspending use for some time. It should be noted that this phenomena does not adversely affect performance reliability.

- n** To minimize the performance degradation of the LCD modules resulting from caused by static electricity, etc. exercise care to avoid holding the following sections when handling the modules:
 - Exposed area of the printed circuit board
 - Terminal electrode sections