

Display Elektronik GmbH

# DATA SHEET

***LCD-MODULE***

## **DEM 240128F FGH-PW**

Product Specification

Ver.: 1

29.08.2017

## **Revision History**

<b>VERSION</b>	<b>DATE</b>	<b>Note</b>
0	01.08.2016	First Issue
1	29.08.2017	Correct FPC. Modify IDD.

# **Contents**

1. General Specification
2. Interface Pin Function
3. Counter Drawing &Block Diagram
4. Optical Characteristics
5. Absolute Maximum Ratings
6. Electrical Characteristics
7. Backlight Information
8. Reliability
9. Inspection specification
10. Precautions in use of LCD Modules
11. Initial Code

# **1. General Specification**

The Features is described as follow:

- Module Dimension: 122.20 x 79.80 x 6.50 mm
- Viewing Area: 114.00 x 64.00 mm
- Active Area: 107.98 x 57.58 mm
- Number of Dots: 240 x 128
- Dot Size: 0.43 x 0.43 mm
- Dot Pitch: 0.45 x 0.45 mm
- LCD Type: FSTN Positive Transflective
- Duty: 1/128Duty , 1/12Bias
- View Direction: 6 o'clock
- Backlight Type: LED White
- IC: ST7586S (Sitronix)

## 2. Interface Pin Function

Pin No.	Symbol	Description																				
1	ESD GND	Electro-Static discharge																				
2	VG	VG is the power of SEG-drivers																				
3	XV0	Negative operating voltage of COM-drivers																				
4	V0	Positive operating voltage of COM-drivers																				
5	VM	VM is the non-select voltage level of COM-drivers																				
6	VDDA	Power supply																				
7	VSS	Ground																				
8	VD1	Digital power source selection																				
9	VDDI	VDD1 is the power of interface I/O circuit																				
10	CSB	Chip select input pin CSB="L": This chip is selected and the MPU interface is active CSB="H": This chip is not selected and the MPU interface is disabled (D[7:0] are high impedance)																				
11	IF3	These pins select interface operation mode																				
12	IF2	<table border="1"> <thead> <tr> <th>IF3</th> <th>IF2</th> <th>IF1</th> <th>MPU interface type</th> </tr> </thead> <tbody> <tr> <td>H</td> <td>H</td> <td>L</td> <td>80 series 8-bit parallel</td> </tr> <tr> <td>H</td> <td>L</td> <td>L</td> <td>68 series 8-bit parallel</td> </tr> <tr> <td>L</td> <td>H</td> <td>H</td> <td>8-bit serial (4-Line)</td> </tr> <tr> <td>L</td> <td>H</td> <td>L</td> <td>9-bit serial (3-Line)</td> </tr> </tbody> </table>	IF3	IF2	IF1	MPU interface type	H	H	L	80 series 8-bit parallel	H	L	L	68 series 8-bit parallel	L	H	H	8-bit serial (4-Line)	L	H	L	9-bit serial (3-Line)
IF3	IF2	IF1	MPU interface type																			
H	H	L	80 series 8-bit parallel																			
H	L	L	68 series 8-bit parallel																			
L	H	H	8-bit serial (4-Line)																			
L	H	L	9-bit serial (3-Line)																			
13	IF1	Note: Refer to "Interface Selection" for detailed information																				
14	RSTB	Reset input pin. When RSTB is "L", internal initialization procedure is executed																				

15	/RD(E)	Read / Write execution control pin. (This pin is only used in parallel interface)						
		MPU Type	ERD	Description	6800-series	E	Read / Write control input pin. R/W = "H": When E is "H", data bus is in output status. R/W = "L": The data are latched at the falling edge of the E signal.	8080-series
MPU Type	ERD	Description						
6800-series	E	Read / Write control input pin. R/W = "H": When E is "H", data bus is in output status. R/W = "L": The data are latched at the falling edge of the E signal.						
8080-series	/RD	Read enable input pin. When /RD is "L", data bus is in output status.						
		This pin is not used in serial interfaces and should be connected to VDD1						
16~23	D7~D0	<p>The bi-directional data bus of the MPU interface. When CSB is "H", they are high impedance</p> <p>If using serial interface: D0 is the SDA signal in 4-Line &amp; 3-Line interface D1 is the A0 signal in 4-Line interface</p>						
24	/WR(R/W)	Read / Write execution control pin. (This pin is only used in parallel interface)						
		MPU Type	RWR	Description	6800-series	R/W	Read / Write control input pin R/W = "H" : read R/W = "L" : write	8080-series
MPU Type	RWR	Description						
6800-series	R/W	Read / Write control input pin R/W = "H" : read R/W = "L" : write						
8080-series	/WR	Write enable clock input pin. The data are latched at the rising edge of the /WR signal.						
		This pin is not used in serial interfaces and should be connected to VDD1						
25	A0(SCL)	<p>The function of this pin is different in parallel and serial interface</p> <p>In parallel interface: A0 is register selection input A0 = "H": inputs on data bus are display data A0 = "L": inputs on data bus are command</p> <p>In serial interface: this pad will be used as SCL (serial-clock) input</p>						
26	ESD GND	Electro-Static discharge						

### 3. Counter Drawing & Block Diagram

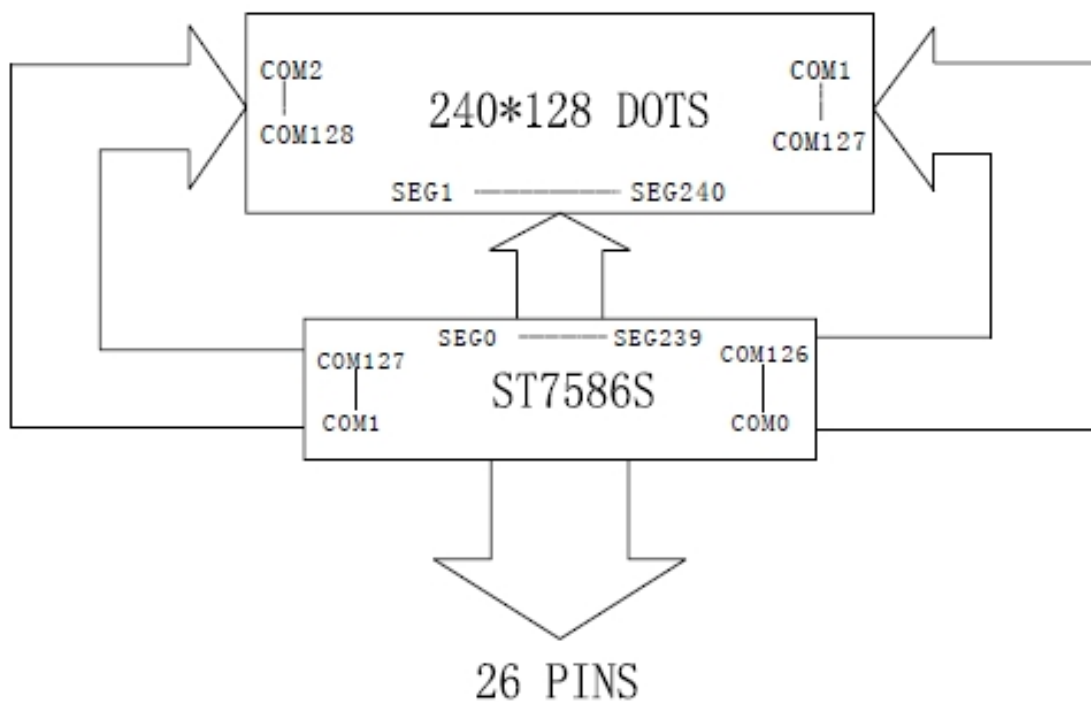
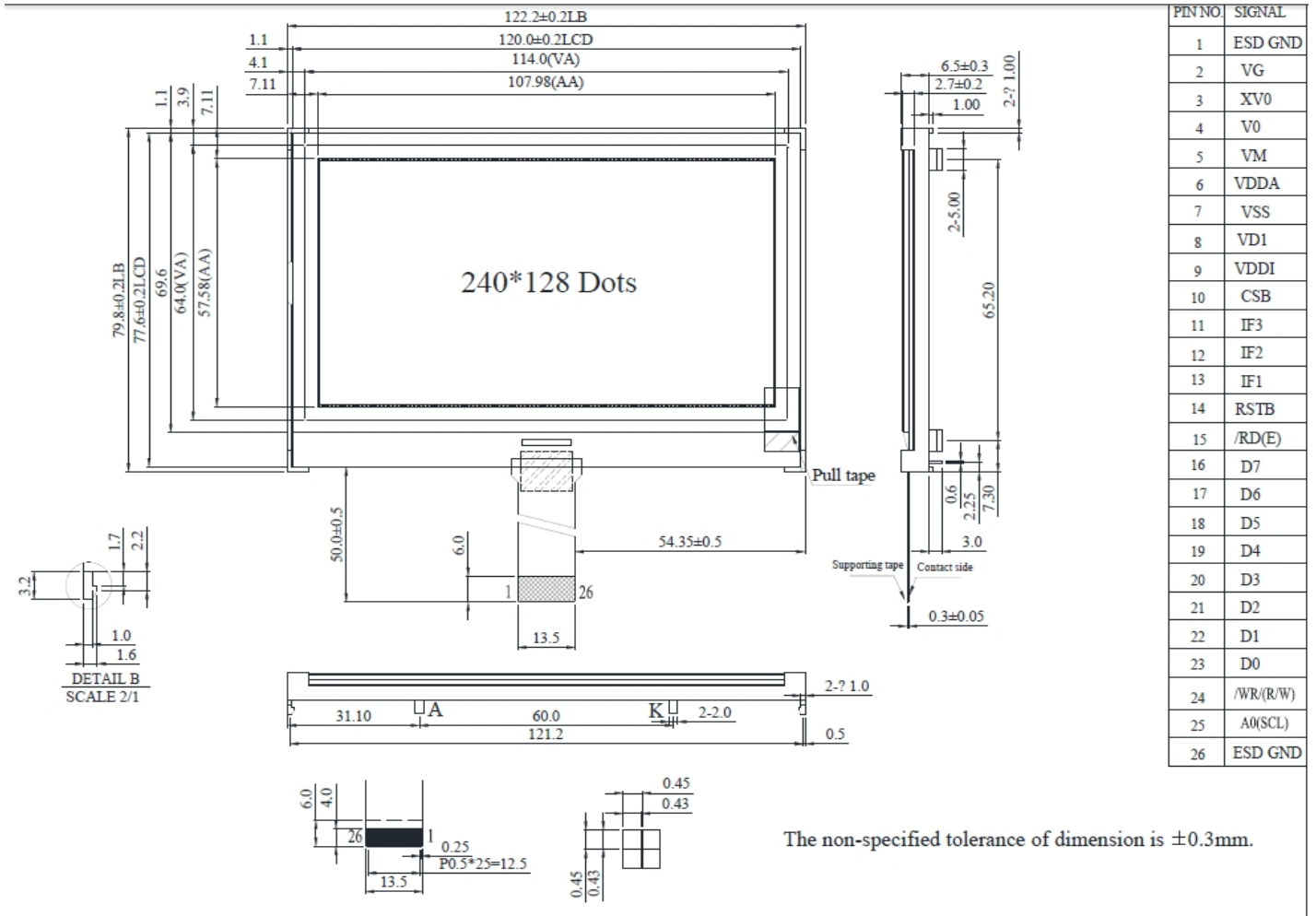

### 4. Optical Characteristics

Item	Symbol	Condition	Min	Typ	Max	Unit
View Angle	$\theta$	$CR \geq 2$	0	—	30	$\psi = 180^\circ$
	$\theta$	$CR \geq 2$	0	—	60	$\psi = 0^\circ$
	$\theta$	$CR \geq 2$	0	—	45	$\psi = 90^\circ$
	$\theta$	$CR \geq 2$	0	—	45	$\psi = 270^\circ$
Contrast Ratio	CR	—	—	5	—	—
Response Time	T rise	—	—	200	300	ms
	T fall	—	—	250	350	ms

Definition of Operation Voltage (Vop)

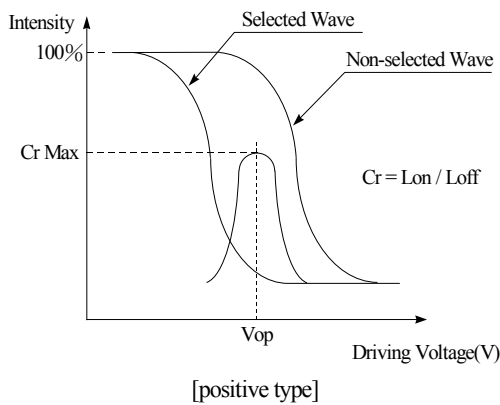

Definition of Response Time (Tr, Tf)

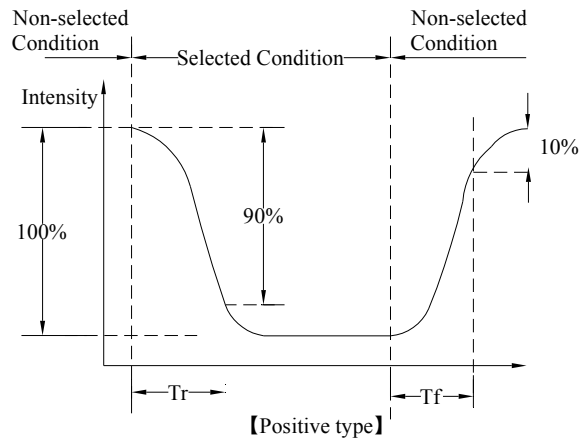

**Conditions :**

Operating Voltage : Vop      Viewing Angle( $\theta, \varphi$ ) :  $0^\circ, 0^\circ$   
 Frame Frequency : 64 HZ    Driving Waveform : 1/N duty , 1/a bias

**Definition of viewing angle( $CR \geq 2$ )**

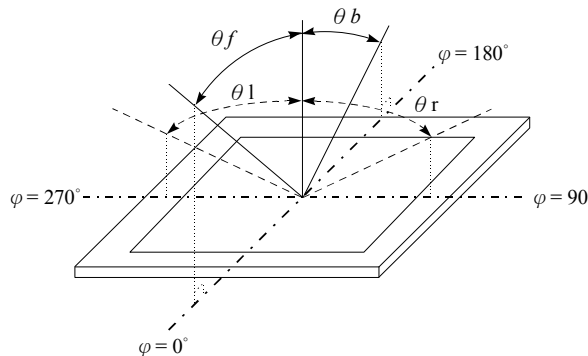



## 5. Absolute Maximum Ratings

Item	Symbol	Min	Typ	Max	Unit
Operating Temperature	T <sub>OP</sub>	-20	—	+70	°C
Storage Temperature	T <sub>ST</sub>	-30	—	+80	°C
Digital Power Supply Voltage	VDDI	-0.3	—	3.6	V
Analog Power Supply Voltage	VDDA	-0.3	—	3.6	V
LCD Power Supply Voltage	V0-XV0	-0.3	—	19	V
LCD Power Supply Voltage	VG	-0.3	—	5.5	V

## 6. Electrical Characteristics

Item	Symbol	Condition	Min	Typ	Max	Unit
Supply Voltage For Logic	$V_{DD}-V_{SS}$	—	3.0	3.3	3.6	V
Supply Voltage For LCM	VOP	Ta=-20°C	—	—	—	V
		Ta=25°C	14.8	15.0	15.2	V
		Ta=+70°C	—	—	—	V
Input High Voltage	$V_{IH}$	—	$0.7V_{DD}$	—	$V_{DD}$	V
Input Low Voltage	$V_{IL}$	—	VSS	—	$0.3 V_{DD}$	V
Output High Voltage	$V_{OH}$	—	$0.8 V_{DD}$	—	$V_{DD}$	V
Output Low Voltage	$V_{OL}$	—	VSS	—	$0.2V_{DD}$	V
Supply Current	$I_{DD}$	$V_{DD}=3.3V$	—	2.0	4.0	mA

Please kindly consider to design the Vop to be adjustable while programing the software to match LCD contrast tolerance.

## 7. Backlight Information

PARAMETER	SYMBOL	MIN	TYP	MAX	UNIT	TEST CONDITION
Supply Current	I <sub>LED</sub>	—	144	180	mA	V=3.5V
Supply Voltage	V	3.4	3.5	3.6	V	—
Reverse Voltage	V <sub>R</sub>	—	—	5	V	—
Color Coordinate	X	0.244	0.264	0.284		I <sub>LED</sub> =144mA
	Y	0.264	0.284	0.304		
Luminance (without LCD)	I <sub>V</sub>	750	940	—	Cd/m <sup>2</sup>	I <sub>LED</sub> =144mA
LED Lifetime (For reference only)	—	—	50000	—	Hr.	I <sub>LED</sub> =144mA 25°C, 50%RH-60%RH, (Note 1)
Color	White					

Note: The LED of B/L is drive by current only, drive voltage is for reference only. drive voltage can make driving current under safety area (current between minimum and maximum).

Note 1: 50000 hours is only an estimate for reference.

### LED B/L Drive Method

#### 1. Drive from A, K

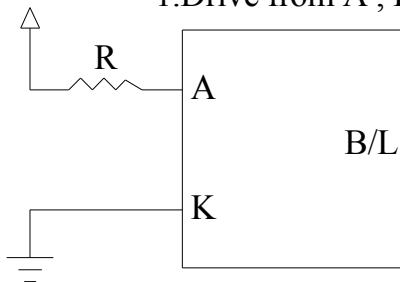

## 8. Reliability

### Content of Reliability Test (Wide temperature, -20°C~70°C)

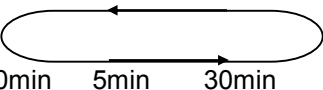
Environmental Test			
Test Item	Content of Test	Test Condition	Note
High Temperature storage	Endurance test applying the high storage temperature for a long time.	80°C 96hrs	2
Low Temperature storage	Endurance test applying the low storage temperature for a long time.	-30°C 96hrs	1,2
High Temperature Operation	Endurance test applying the electric stress (Voltage & Current) and the thermal stress to the element for a long time.	70°C 96hrs	—
Low Temperature Operation	Endurance test applying the electric stress under low temperature for a long time.	-20°C 96hrs	1
High Temperature/ Humidity storage	The module should be allowed to stand at 60□,90%RH max For 96hrs under no-load condition excluding the polarizer, Then taking it out and drying it at normal temperature.	60°C,90%RH 96hrs	1,2
Thermal shock resistance	The sample should be allowed stand the following 10 cycles of operation -20°C    25°C    70°C  1 cycle	-20°C/70°C 10 cycles	—
Vibration test	Endurance test applying the vibration during transportation and using.	Total fixed amplitude : 1.5mm Vibration Frequency : 10~55Hz One cycle 60 seconds to 3 directions of X,Y,Z for Each 15 minutes	3
Static electricity test	Endurance test applying the electric stress to the terminal.	VS=±600V (Contact), ±800V(Air), RS=330Ω CS=150pF 10 times	—

Note1: No dew condensation to be observed.

Note2: The function test shall be conducted after 4 hours storage at the normal Temperature and humidity after remove from the test chamber.

Note3: The packing have to including into the vibration testing.

### 9. Inspection specification

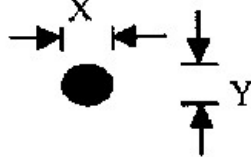
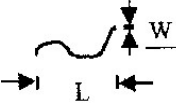
NO	Item	Criterion	AQL													
01	Electrical Testing	1.1 Missing vertical, horizontal segment, segment contrast defect. 1.2 Missing character , dot or icon. 1.3 Display malfunction. 1.4 No function or no display. 1.5 Current consumption exceeds product specifications. 1.6 LCD viewing angle defect. 1.7 Mixed product types. 1.8 Contrast defect.	0.65													
02	Black or white spots on LCD (display only)	2.1 White and black spots on display $\leq 0.25\text{mm}$ , no more than three white or black spots present. 2.2 Densely spaced: No more than two spots or lines within 3mm	2.5													
03	LCD black spots, white spots, contamination (non-display)	3.1 Round type : As following drawing  $\Phi = (x + y) / 2$  <table border="1" data-bbox="805 981 1332 1236"> <thead> <tr> <th>SIZE</th> <th>Acceptable Q TY</th> </tr> </thead> <tbody> <tr> <td><math>\Phi \leq 0.10</math></td> <td>Accept no dense</td> </tr> <tr> <td><math>0.10 &lt; \Phi \leq 0.20</math></td> <td>2</td> </tr> <tr> <td><math>0.20 &lt; \Phi \leq 0.25</math></td> <td>1</td> </tr> <tr> <td><math>0.25 &lt; \Phi</math></td> <td>0</td> </tr> </tbody> </table>	SIZE	Acceptable Q TY	$\Phi \leq 0.10$	Accept no dense	$0.10 < \Phi \leq 0.20$	2	$0.20 < \Phi \leq 0.25$	1	$0.25 < \Phi$	0	2.5			
		SIZE	Acceptable Q TY													
$\Phi \leq 0.10$	Accept no dense															
$0.10 < \Phi \leq 0.20$	2															
$0.20 < \Phi \leq 0.25$	1															
$0.25 < \Phi$	0															
3.2 Line type : (As following drawing)   <table border="1" data-bbox="699 1321 1332 1579"> <thead> <tr> <th>Length</th> <th>Width</th> <th>Acceptable Q TY</th> </tr> </thead> <tbody> <tr> <td>---</td> <td><math>W \leq 0.02</math></td> <td>Accept no dense</td> </tr> <tr> <td><math>L \leq 3.0</math></td> <td><math>0.02 &lt; W \leq 0.03</math></td> <td rowspan="2">2</td> </tr> <tr> <td><math>L \leq 2.5</math></td> <td><math>0.03 &lt; W \leq 0.05</math></td> </tr> <tr> <td>---</td> <td><math>0.05 &lt; W</math></td> <td>As round type</td> </tr> </tbody> </table>	Length	Width	Acceptable Q TY	---	$W \leq 0.02$	Accept no dense	$L \leq 3.0$	$0.02 < W \leq 0.03$	2	$L \leq 2.5$	$0.03 < W \leq 0.05$	---	$0.05 < W$	As round type	2.5	
Length	Width	Acceptable Q TY														
---	$W \leq 0.02$	Accept no dense														
$L \leq 3.0$	$0.02 < W \leq 0.03$	2														
$L \leq 2.5$	$0.03 < W \leq 0.05$															
---	$0.05 < W$	As round type														
04	Polarizer bubbles	If bubbles are visible, judge using black spot specifications, not easy to find, must check in specify direction.	<table border="1" data-bbox="826 1691 1332 1993"> <thead> <tr> <th>Size <math>\Phi</math></th> <th>Acceptable Q TY</th> </tr> </thead> <tbody> <tr> <td><math>\Phi \leq 0.20</math></td> <td>Accept no dense</td> </tr> <tr> <td><math>0.20 &lt; \Phi \leq 0.50</math></td> <td>3</td> </tr> <tr> <td><math>0.50 &lt; \Phi \leq 1.00</math></td> <td>2</td> </tr> <tr> <td><math>1.00 &lt; \Phi</math></td> <td>0</td> </tr> <tr> <td>Total Q TY</td> <td>3</td> </tr> </tbody> </table>	Size $\Phi$	Acceptable Q TY	$\Phi \leq 0.20$	Accept no dense	$0.20 < \Phi \leq 0.50$	3	$0.50 < \Phi \leq 1.00$	2	$1.00 < \Phi$	0	Total Q TY	3	2.5
Size $\Phi$	Acceptable Q TY															
$\Phi \leq 0.20$	Accept no dense															
$0.20 < \Phi \leq 0.50$	3															
$0.50 < \Phi \leq 1.00$	2															
$1.00 < \Phi$	0															
Total Q TY	3															

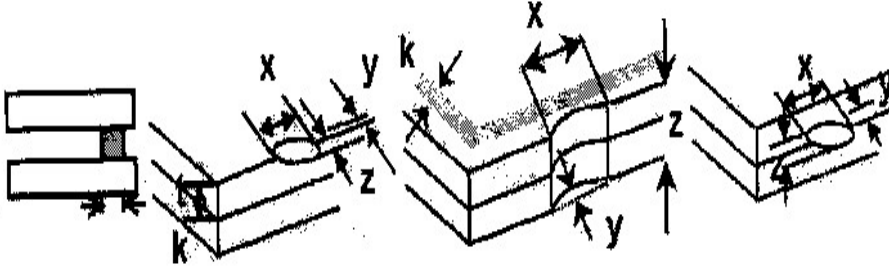
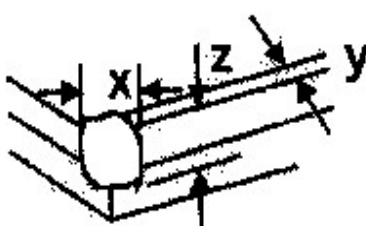
NO	Item	Criterion	AQL																		
05	Scratches	Follow NO.3 LCD black spots, white spots, contamination																			
06	Chipped glass	<p>Symbols Define:                      x: Chip length      y: Chip width      z: Chip thickness                      k: Seal width      t: Glass thickness      a: LCD side length                      L: Electrode pad length:</p> <p>6.1 General glass chip :                      6.1.1 Chip on panel surface and crack between panels:</p>  <table border="1" data-bbox="443 925 1353 1133"> <thead> <tr> <th>z: Chip thickness</th> <th>y: Chip width</th> <th>x: Chip length</th> </tr> </thead> <tbody> <tr> <td><math>Z \leq 1/2t</math></td> <td>Not over viewing area</td> <td><math>x \leq 1/8a</math></td> </tr> <tr> <td><math>1/2t &lt; z \leq 2t</math></td> <td>Not exceed 1/3k</td> <td><math>x \leq 1/8a</math></td> </tr> </tbody> </table> <p>⊙ If there are 2 or more chips, x is total length of each chip.</p> <p>6.1.2 Corner crack:</p>  <table border="1" data-bbox="443 1568 1353 1776"> <thead> <tr> <th>z: Chip thickness</th> <th>y: Chip width</th> <th>x: Chip length</th> </tr> </thead> <tbody> <tr> <td><math>Z \leq 1/2t</math></td> <td>Not over viewing area</td> <td><math>x \leq 1/8a</math></td> </tr> <tr> <td><math>1/2t &lt; z \leq 2t</math></td> <td>Not exceed 1/3k</td> <td><math>x \leq 1/8a</math></td> </tr> </tbody> </table> <p>⊙ If there are 2 or more chips, x is the total length of each chip.</p>	z: Chip thickness	y: Chip width	x: Chip length	$Z \leq 1/2t$	Not over viewing area	$x \leq 1/8a$	$1/2t < z \leq 2t$	Not exceed 1/3k	$x \leq 1/8a$	z: Chip thickness	y: Chip width	x: Chip length	$Z \leq 1/2t$	Not over viewing area	$x \leq 1/8a$	$1/2t < z \leq 2t$	Not exceed 1/3k	$x \leq 1/8a$	2.5
z: Chip thickness	y: Chip width	x: Chip length																			
$Z \leq 1/2t$	Not over viewing area	$x \leq 1/8a$																			
$1/2t < z \leq 2t$	Not exceed 1/3k	$x \leq 1/8a$																			
z: Chip thickness	y: Chip width	x: Chip length																			
$Z \leq 1/2t$	Not over viewing area	$x \leq 1/8a$																			
$1/2t < z \leq 2t$	Not exceed 1/3k	$x \leq 1/8a$																			

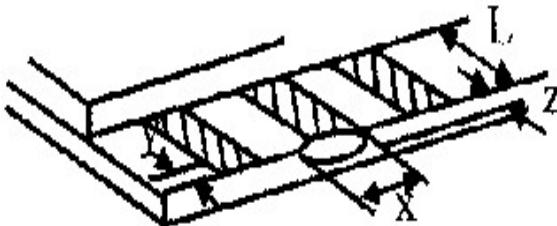
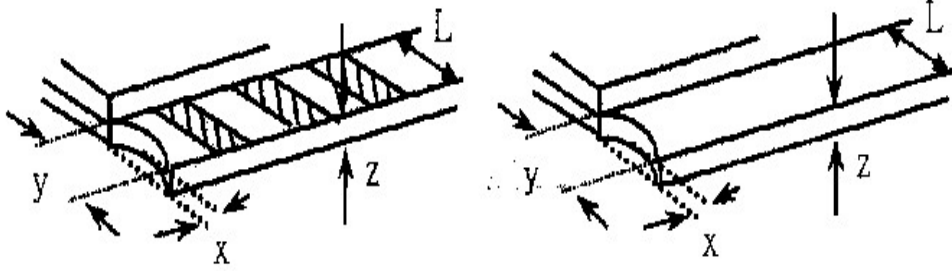
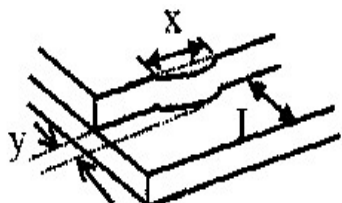
NO	Item	Criterion	AQL							
06	Glass crack	<p>Symbols :</p> <p>x: Chip length      y: Chip width      z: Chip thickness</p> <p>k: Seal width      t: Glass thickness      a: LCD side length</p> <p>L: Electrode pad length</p> <p>6.2 Protrusion over terminal :</p> <p>6.2.1 Chip on electrode pad :</p>  <table border="1" data-bbox="363 801 1284 902"> <thead> <tr> <th>y: Chip width</th> <th>x: Chip length</th> <th>z: Chip thickness</th> </tr> </thead> <tbody> <tr> <td><math>y \leq 0.5\text{mm}</math></td> <td><math>x \leq 1/8a</math></td> <td><math>0 &lt; z \leq t</math></td> </tr> </tbody> </table>	y: Chip width	x: Chip length	z: Chip thickness	$y \leq 0.5\text{mm}$	$x \leq 1/8a$	$0 < z \leq t$	2.5	
		y: Chip width	x: Chip length	z: Chip thickness						
$y \leq 0.5\text{mm}$	$x \leq 1/8a$	$0 < z \leq t$								
<p>6.2.2 Non-conductive portion:</p>  <table border="1" data-bbox="434 1288 1260 1400"> <thead> <tr> <th>y: Chip width</th> <th>x: Chip length</th> <th>z: Chip thickness</th> </tr> </thead> <tbody> <tr> <td><math>y \leq L</math></td> <td><math>x \leq 1/8a</math></td> <td><math>0 &lt; z \leq t</math></td> </tr> </tbody> </table> <p>⊙ If the chipped area touches the ITO terminal, over 2/3 of the ITO must remain and be inspected according to electrode terminal specifications.</p> <p>⊙ If the product will be heat sealed by the customer, the alignment mark not be damaged.</p> <p>6.2.3 Substrate protuberance and internal crack.</p>  <table border="1" data-bbox="774 1702 1332 1803"> <thead> <tr> <th>y: width</th> <th>x: length</th> </tr> </thead> <tbody> <tr> <td><math>y \leq 1/3L</math></td> <td><math>x \leq a</math></td> </tr> </tbody> </table>	y: Chip width	x: Chip length	z: Chip thickness	$y \leq L$	$x \leq 1/8a$	$0 < z \leq t$	y: width	x: length	$y \leq 1/3L$	$x \leq a$
y: Chip width	x: Chip length	z: Chip thickness								
$y \leq L$	$x \leq 1/8a$	$0 < z \leq t$								
y: width	x: length									
$y \leq 1/3L$	$x \leq a$									

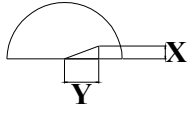
NO	Item	Criterion	AQL
07	Cracked glass	The LCD with extensive crack is not acceptable.	2.5
08	Backlight elements	8.1 Illumination source flickers when lit. 8.2 Spots or scratched that appear when lit must be judged. Using LCD spot, lines and contamination standards. 8.3 Backlight doesn't light or color wrong.	0.65 2.5 0.65
09	Bezel	9.1 Bezel may not have rust, be deformed or have fingerprints, stains or other contamination. 9.2 Bezel must comply with job specifications.	2.5 0.65
10	PCB · COB	10.1 COB seal may not have pinholes larger than 0.2mm or contamination. 10.2 COB seal surface may not have pinholes through to the IC. 10.3 The height of the COB should not exceed the height indicated in the assembly diagram. 10.4 There may not be more than 2mm of sealant outside the seal area on the PCB. And there should be no more than three places. 10.5 No oxidation or contamination PCB terminals. 10.6 Parts on PCB must be the same as on the production characteristic chart. There should be no wrong parts, missing parts or excess parts. 10.7 The jumper on the PCB should conform to the product characteristic chart. 10.8 If solder gets on bezel tab pads, LED pad, zebra pad or screw hold pad, make sure it is smoothed down. 10.9 The Scraping testing standard for Copper Coating of PCB  $X * Y \leq 2\text{mm}^2$	2.5 2.5 0.65 2.5 2.5 0.65 0.65 2.5 2.5
11	Soldering	11.1 No un-melted solder paste may be present on the PCB. 11.2 No cold solder joints, missing solder connections, oxidation or icicle. 11.3 No residue or solder balls on PCB. 11.4 No short circuits in components on PCB.	2.5 2.5 2.5 0.65



NO	Item	Criterion	AQL
12	General appearance	12.1 No oxidation, contamination, curves or, bends on interface Pin (OLB) of TCP.	2.5
		12.2 No cracks on interface pin (OLB) of TCP.	0.65
		12.3 No contamination, solder residue or solder balls on product.	2.5
		12.4 The IC on the TCP may not be damaged, circuits.	2.5
		12.5 The uppermost edge of the protective strip on the interface pin must be present or look as if it cause the interface pin to sever.	2.5
		12.6 The residual rosin or tin oil of soldering (component or chip component) is not burned into brown or black color.	2.5
		12.7 Sealant on top of the ITO circuit has not hardened.	0.65
		12.8 Pin type must match type in specification sheet.	0.65
		12.9 LCD pin loose or missing pins.	0.65
		12.10 Product packaging must the same as specified on packaging specification sheet.	0.65
		12.11 Product dimension and structure must conform to product specification sheet.	0.65
		12.12 Visual defect outside of VA is not considered to be rejection.	

## **10. Precautions in use of LCD Modules**

- (1) Avoid applying excessive shocks to the module or making any alterations or modifications to it.
- (2) Don't make extra holes on the printed circuit board, modify its shape or change the components of LCD module.
- (3) Don't disassemble the LCM.
- (4) Don't operate it above the absolute maximum rating.
- (5) Don't drop, bend or twist LCM.
- (6) Soldering: only to the I/O terminals.
- (7) Storage: please storage in anti-static electricity container and clean environment.
- (8) DISPLAY have the right to change the passive components, including R3,R6 & backlight adjust resistors. (Resistors,capacitors and other passive components will have different appearance and color caused by the different supplier.)
- (9) DISPLAY have the right to change the PCB Rev. (In order to satisfy the supplying stability, management optimization and the best product performance...etc, under the premise of not affecting the electrical characteristics and external dimensions, DISPLAY have the right to modify the version.)
- (10) To ensure the stability of the display screen, please apply screen saver after showing 30 mins of fixed display content.

**10. Initial Code**

//For FSTN White

```
void initial()
{

    RES=1;
    delay(200);
    RES=0;
    delay(200);
    RES=1;
    delay(200);

    write_com(0xD7);    // Disable Auto Read
    write_dat(0x9F);
    write_com(0xE0);    // Enable OTP Read
    write_dat(0x00);
    delay(20);
    write_com(0xE3);    // OTP Up-Load
    delay(20);
    write_com(0xE1);    // OTP Control Out
    write_com(0x11);    // Sleep Out
    write_com(0x28);    // Display OFF
    delay(50);

    write_com(0xC0);    //----- Vop = 0X11Dh -----
    write_dat(0x1D);    //
    write_dat(0x01);    //

    write_com(0xC3);    // BIAS = 1/12 -----
    write_dat(0x02);    //

    write_com(0xC4);    // Set Booster
    write_dat(0x07);

    write_com(0xD0);    // Enable Analog Circuit
    write_dat(0x1D);

    write_com(0xB5);    // N-Line = 0 ; Frame inversion
```

```
write_dat(0x00);

write_com(0x39); //Display Mode : Monochrome mode(B/W Mode)

//----- FSTN White Temperature Compensation
write_com(0xF1); // Frame Rate (Monochrome Mode)
write_dat(0x06); //
write_dat(0x0B); //
write_dat(0x0D);
write_dat(0x12); //
//----- FSTN White Temperature Compensation
write_com(0xF4); //Temperature Gradient Compensation
write_dat(0x7F); //MT1 , MT0
write_dat(0x22); //MT3 , MT2
write_dat(0x11); //MT5 , MT4
write_dat(0x02); //MT7 , MT6
write_dat(0x00); //MT9 , MT8
write_dat(0x32); //MTB , MTA
write_dat(0x82); //MTD , MTC
write_dat(0xB6); //MTF , MTE
//-----

write_com(0x3A); // Enable DDRAM Interface
write_dat(0x02);

write_com(0x36); // Scan Direction Setting/Display Control
write_dat(0x00);

write_com(0xB0); // Duty Setting -----
write_dat(0x7F); // 1/128Duty
//////////
write_com(0x20); // Normal display

write_com(0x37); // Start Line
write_dat(0x00); //

write_com(0xB1); // First Output COM
write_dat(0x00); //
//////////
```

```
write_com(0xB3);    //FOSC Divider
write_dat(0x00);    //

write_com(0x2A);    // Column Address Setting
write_dat(0x00);
write_dat(0x00);
write_dat(0x00);
write_dat(79);      //

write_com(0x2B);    // Row Address Setting
write_dat(0x00);
write_dat(0x00);
write_dat(0x00);
write_dat(127);    //

write_com(0x29);    // Display ON
}
```