

Display Elektronik GmbH

DATA SHEET

LCD MODULE

DEM 240160B SBH-PW-N

Product Specification

Ver.: 1

13/Jan./2017

DOCUMENT REVISION HISTORY

Version	DATE	DESCRIPTION	CHANGED BY
0	Oct-30-2009	First issue	MH
1	Jan-13-2017	Updated dimensional outline at page 3.	MHO

CONTENTS

1. Functions & Features	2
2. Mechanical specifications	2
3. Block diagram	2
4. Dimensional outline	3
5. Pin description	4
6. Maximum absolute limit	6
7. Electrical characteristics	6
8. Timing characteristics	7
9. Control and display command	9
10. Electro-Optical characteristics	11
11. Backlight characteristics	11
12. Precaution for using LCD/LCM	12

1. FUNCTIONS & FEATURES

Format	: 240*160 Dots
LCD mode	: STN /Negative /Transmissive/Blue Mode
Viewing direction	: 6 o'clock
Driving scheme	: 1/160 Duty cycle, 1/12 Bias
Power supply voltage (V _{DD})	: 3.3 Volt (typ.)
LCD driving voltage (VLCD)	: 16.0 Volt (typ.) (Reference voltage)
Driver IC	: UC1698u (Ultrachip) (or compatible)
Operation temp	: -20°C to +70°C
Storage temp	: -30°C to +80°C
Back light	: LED, White, Lightguide, 7 LEDs
RoHS	: Compliant.

2. MECHANICAL SPECIFICATIONS

Module size	: 105.50 x 67.20 x 4.20 mm
Viewing area	: 99.00 x 57.50 mm
Dot pitch	: 0.35 x 0.32 mm
Dot size	: 0.33 x 0.30 mm

3. BLOCK DIAGRAM

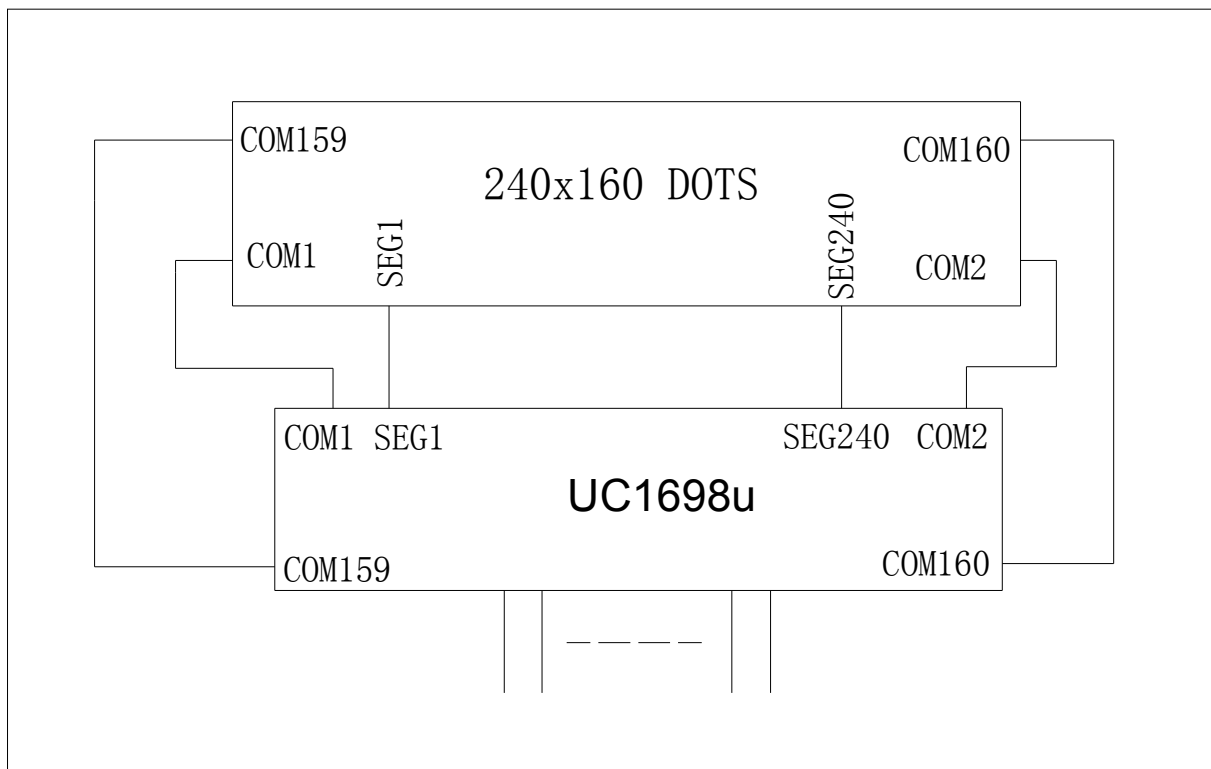

4. DIMENSIONAL OUTLINE

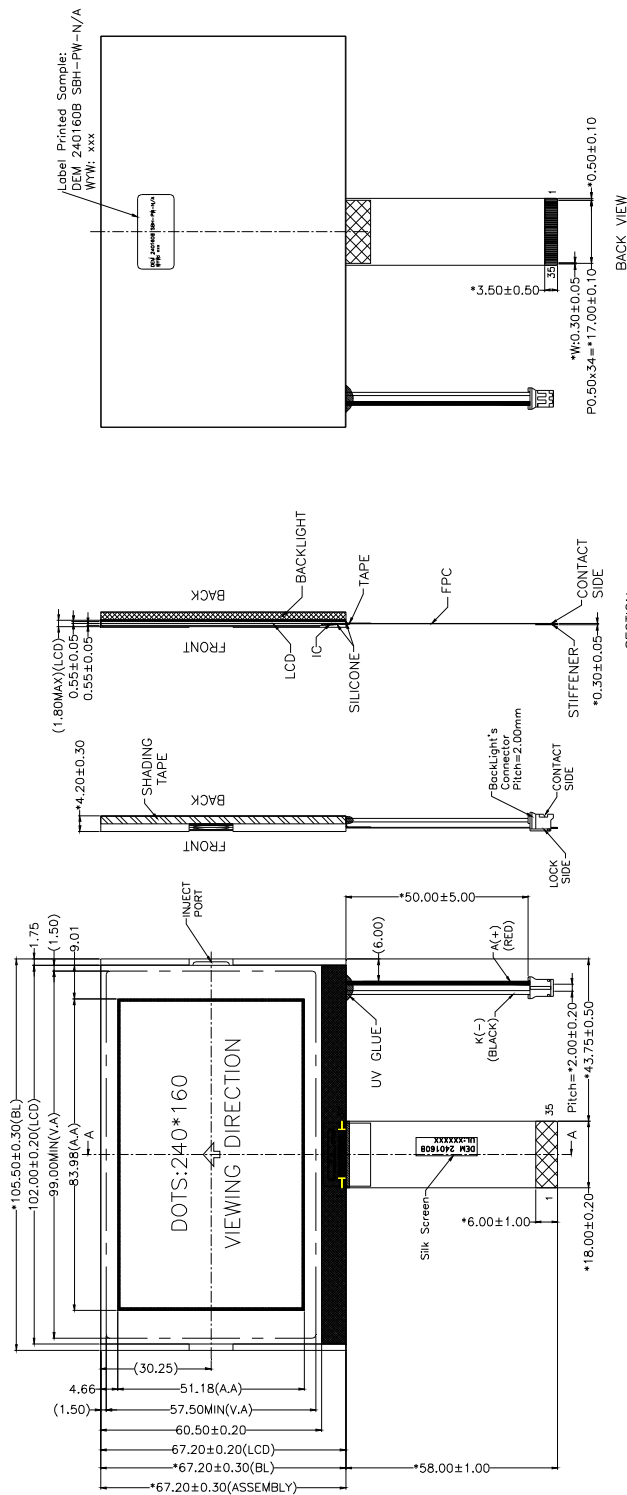

FPC INTERFACE															
PIN	1	2	3	4	5	6	7	8	9						
CONNECTION	VLCD	VS+	VS-	VBO-	VBI+	VBO+	VOD	VSS							
PIN	10	11	12	13	14	15	16	17	18						
CONNECTION	ID1	100	TST4	BMT	BMO	CSD	CD	WR1	WR0						
PIN	19	20	21	22	23	24	25	26	27						
CONNECTION	RST	DO	D1	D2	D3	D4	D5	D6	D7						
PIN	28	29	30	31	32	33	34	35							
CONNECTION	DB	D9	D10	D11	D12	D13	D14	D15							

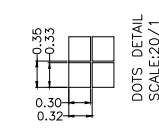
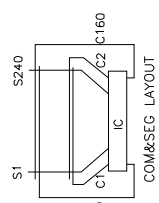
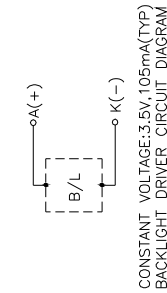

5. PIN DESCRIPTION

1	VLCD	Power supply for LCD voltage																								
2~7	VS+, VS-, VB0-, VB1-, VB1+, VB0+	LCD SEG driving voltages.																								
8	VDD	Power supply for logic(+3.3V)																								
9	VSS	Ground																								
10	ID1	Selects Input Data set for 8-bit mode. ID1=0 : 8-bit input data are D[0,2,4,6,8,10,12,14] ID1=1 : 8-bit input data are D[0:7] The wiring status of ID pins is available in PID[1:0] with command <code>Get Status</code> . Other than 8-bit mode, connect ID1 to V _{DD} for "H", or V _{SS} for "L".																								
11	ID0	ID0 pin can be used for production control. Connect ID0 pin to V _{DD} for "H" or V _{SS} for "L".																								
12	TST4	Test control. This pin has on-chip pull-up resistor. Leave it open during normal operation. TST4 is also used as one of the high voltage power supply for MTP programming operation. For COG designs, please wire out TST4 with trace resistance between 30~50 Ω.																								
13,14	BM1, BM0	Bus mode: The interface bus mode is determined by BM[1:0] and {DB15, DB13} by the following relationship: <table border="1" data-bbox="563 1265 1355 1709"> <thead> <tr> <th>BM[1:0]</th> <th>{DB15, DB13}</th> <th>Mode</th> </tr> </thead> <tbody> <tr> <td>11</td> <td>Data</td> <td>6800/16-bit</td> </tr> <tr> <td>10</td> <td>Data</td> <td>8080/16-bit</td> </tr> <tr> <td>01</td> <td>0x</td> <td>6800/8-bit</td> </tr> <tr> <td>00</td> <td>0x</td> <td>8080/8-bit</td> </tr> <tr> <td>00</td> <td>10</td> <td>4-wire SPI w/ 8-bit token (S8: conventional)</td> </tr> <tr> <td>00</td> <td>11</td> <td>3/4-wire SPI w/ 8-bit token (S8uc: Ultra-Compact)</td> </tr> <tr> <td>01</td> <td>10</td> <td>3-wire SPI w/ 9-bit taken (S9: conventional)</td> </tr> </tbody> </table>	BM[1:0]	{DB15, DB13}	Mode	11	Data	6800/16-bit	10	Data	8080/16-bit	01	0x	6800/8-bit	00	0x	8080/8-bit	00	10	4-wire SPI w/ 8-bit token (S8: conventional)	00	11	3/4-wire SPI w/ 8-bit token (S8uc: Ultra-Compact)	01	10	3-wire SPI w/ 9-bit taken (S9: conventional)
BM[1:0]	{DB15, DB13}	Mode																								
11	Data	6800/16-bit																								
10	Data	8080/16-bit																								
01	0x	6800/8-bit																								
00	0x	8080/8-bit																								
00	10	4-wire SPI w/ 8-bit token (S8: conventional)																								
00	11	3/4-wire SPI w/ 8-bit token (S8uc: Ultra-Compact)																								
01	10	3-wire SPI w/ 9-bit taken (S9: conventional)																								
15	CS0	Chip select signal																								
16	CD	Selects Control data or Display data for read/write operation. In S9 mode, CD pin is not used. Connect to V _{SS} when not used. "L": Control data "H": Display data																								

17,18	WR1 ,WR0	<p>WR[1:0] control the read/write operation of the host interface. See section <i>Host Interface</i> for more detail.</p> <p>In parallel mode, the meaning of WR[1:0] depends on whether the interface is in the 6800 mode or the 8080 mode. In serial interface modes, these two pins are not used, connect them to V_{SS}.</p>																																																																																																						
19	RST	The RESET signal																																																																																																						
20~35	D0~D15	<p>Bi-directional bus for parallel host interfaces.</p> <p>In serial modes, connect DB[0] to SCK, DB[8] to SDA.</p> <table border="1" data-bbox="560 600 1428 1305"> <thead> <tr> <th></th> <th>BM=1x (16-bit)</th> <th>BM=0x (8-bit) ID1=0</th> <th>BM=0x (8-bit) ID1=1</th> <th>BM=00 (S8/S8uc)</th> <th>BM=01 (S9)</th> </tr> </thead> <tbody> <tr><td>DB0</td><td>D0</td><td>D0/D8</td><td>D0/D8</td><td>SCK</td><td>SCK</td></tr> <tr><td>DB1</td><td>D1</td><td>-</td><td>D1/D9</td><td>-</td><td>-</td></tr> <tr><td>DB2</td><td>D2</td><td>D1/D9</td><td>D2/D10</td><td>-</td><td>-</td></tr> <tr><td>DB3</td><td>D3</td><td>-</td><td>D3/D11</td><td>-</td><td>-</td></tr> <tr><td>DB4</td><td>D4</td><td>D2/D10</td><td>D4/D12</td><td>-</td><td>-</td></tr> <tr><td>DB5</td><td>D5</td><td>-</td><td>D5/D13</td><td>-</td><td>-</td></tr> <tr><td>DB6</td><td>D6</td><td>D3/D11</td><td>D6/D14</td><td>-</td><td>-</td></tr> <tr><td>DB7</td><td>D7</td><td>-</td><td>D7/D15</td><td>-</td><td>-</td></tr> <tr><td>DB8</td><td>D8</td><td>D4/D12</td><td>-</td><td>SDA</td><td>SDA</td></tr> <tr><td>DB9</td><td>D9</td><td>-</td><td>-</td><td>-</td><td>-</td></tr> <tr><td>DB10</td><td>D10</td><td>D5/D13</td><td>-</td><td>-</td><td>-</td></tr> <tr><td>DB11</td><td>D11</td><td>-</td><td>-</td><td>-</td><td>-</td></tr> <tr><td>DB12</td><td>D12</td><td>D6/D14</td><td>-</td><td>-</td><td>-</td></tr> <tr><td>DB13</td><td>D13</td><td>-</td><td>-</td><td>0:S8/1:S8uc</td><td>0</td></tr> <tr><td>DB14</td><td>D14</td><td>D7/D15</td><td>-</td><td>-</td><td>-</td></tr> <tr><td>DB15</td><td>D15</td><td>0</td><td>0</td><td>1</td><td>1</td></tr> </tbody> </table> <p>Always connect unused pins to either V_{SS} or V_{DD}.</p>		BM=1x (16-bit)	BM=0x (8-bit) ID1=0	BM=0x (8-bit) ID1=1	BM=00 (S8/S8uc)	BM=01 (S9)	DB0	D0	D0/D8	D0/D8	SCK	SCK	DB1	D1	-	D1/D9	-	-	DB2	D2	D1/D9	D2/D10	-	-	DB3	D3	-	D3/D11	-	-	DB4	D4	D2/D10	D4/D12	-	-	DB5	D5	-	D5/D13	-	-	DB6	D6	D3/D11	D6/D14	-	-	DB7	D7	-	D7/D15	-	-	DB8	D8	D4/D12	-	SDA	SDA	DB9	D9	-	-	-	-	DB10	D10	D5/D13	-	-	-	DB11	D11	-	-	-	-	DB12	D12	D6/D14	-	-	-	DB13	D13	-	-	0:S8/1:S8uc	0	DB14	D14	D7/D15	-	-	-	DB15	D15	0	0	1	1
	BM=1x (16-bit)	BM=0x (8-bit) ID1=0	BM=0x (8-bit) ID1=1	BM=00 (S8/S8uc)	BM=01 (S9)																																																																																																			
DB0	D0	D0/D8	D0/D8	SCK	SCK																																																																																																			
DB1	D1	-	D1/D9	-	-																																																																																																			
DB2	D2	D1/D9	D2/D10	-	-																																																																																																			
DB3	D3	-	D3/D11	-	-																																																																																																			
DB4	D4	D2/D10	D4/D12	-	-																																																																																																			
DB5	D5	-	D5/D13	-	-																																																																																																			
DB6	D6	D3/D11	D6/D14	-	-																																																																																																			
DB7	D7	-	D7/D15	-	-																																																																																																			
DB8	D8	D4/D12	-	SDA	SDA																																																																																																			
DB9	D9	-	-	-	-																																																																																																			
DB10	D10	D5/D13	-	-	-																																																																																																			
DB11	D11	-	-	-	-																																																																																																			
DB12	D12	D6/D14	-	-	-																																																																																																			
DB13	D13	-	-	0:S8/1:S8uc	0																																																																																																			
DB14	D14	D7/D15	-	-	-																																																																																																			
DB15	D15	0	0	1	1																																																																																																			

6. MAXIMUM ABSOLUTE LIMIT

Maximum Ratings (Voltage Reference to VSS) (for IC)

ABSOLUTE MAXIMUM RATINGS

In accordance with IEC134, Note 1 and 2

Symbol	Parameter	Min.	Max.	Unit
V _{DD}	Logic Supply voltage	-0.3	+4.0	V
V _{DD2}	LCD Generator Supply voltage	-0.3	+4.0	V
V _{DD3}	Analog Circuit Supply voltage	-0.3	+4.0	V
V _{DD2/3} -V _{DD}	Voltage difference between V _{DD} and V _{DD2/3}	--	1.6	V
V _{LCD}	LCD Driving voltage (-25°C ~ +75°C)	-0.3	+19.8	V
V _{IN}	Digital input signal	-0.4	V _{DD} + 0.5	V
T _{OPR}	Operating temperature range	-30	+85	°C
T _{STR}	Storage temperature	-55	+125	°C

NOTE:

- V_{DD} is based on V_{SS} = 0V
- Stress beyond ranges listed above may cause permanent damages to the device.

7. ELECTRICAL CHARACTERISTICS

DC CHARACTERISTICS

DC CHARACTERISTICS

Symbol	Parameter	Conditions	Min.	Typ.	Max.	Unit
V _{DD}	Supply for digital circuit		1.65		3.3	V
V _{DD2/3}	Supply for bias & pump		2.7		3.3	V
V _{LCD}	Charge pump output	V _{DD2/3} = 2.8V, 25°C		15.2	18	V
V _D	LCD data voltage	V _{DD2/3} = 2.8V, 25°C	1.09		1.95	V
V _{IL}	Input logic LOW				0.2V _{DD}	V
V _{IH}	Input logic HIGH		0.8V _{DD}			V
V _{OL}	Output logic LOW				0.2V _{DD}	V
V _{OH}	Output logic HIGH		0.8V _{DD}			V
I _{IL}	Input leakage current				1.5	μA
I _{SB}	Standby current	V _{DD} = V _{DD2/3} = 3.3V, Temp = 85°C			50	μA
C _{IN}	Input capacitance			5	10	PF
C _{OUT}	Output capacitance			5	10	PF
R _{ON(SEG)}	SEG output impedance	V _{LCD} = 16.5V		850	1100	Ω
R _{ON(COM)}	COM output impedance	V _{LCD} = 16.5V		950	1100	Ω
f _{LINE}	Average line rate	LC[4:3] = 10b, 25°C	-10%	37.0	+10%	Klps

8. TIMING CHARACTERISTICS

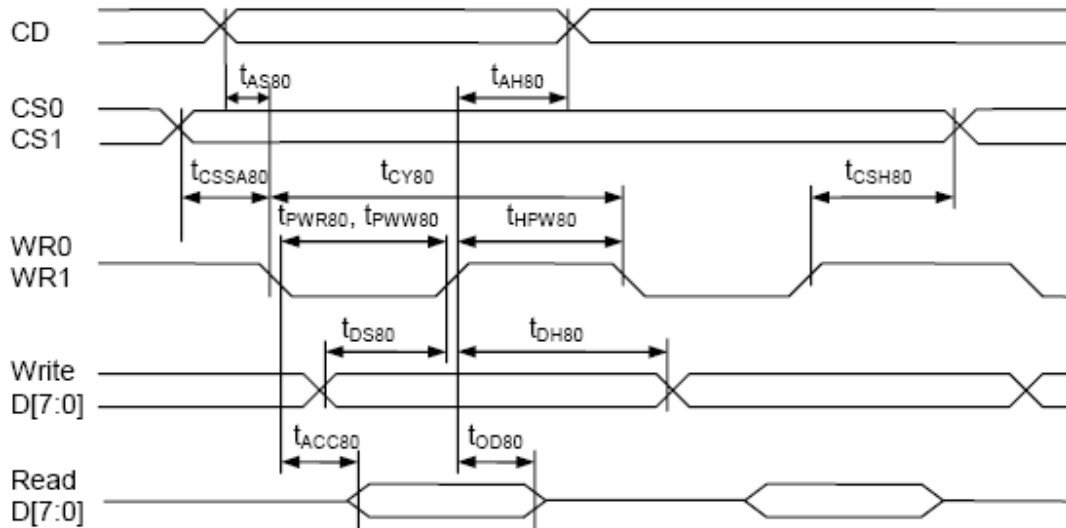

Parallel Bus Timing Characteristics (for 8080 MCU)

(2.5V ≤ V_{DD} < 3.3V, Ta = -30 to +85°C)

Symbol	Signal	Description	Condition	Min.	Max.	Units
t _{AS80}	CD	Address setup time		0	-	nS
t _{AH80}		Address hold time		0	-	nS
t _{CY80}		System cycle time				nS
		16-bit bus (read)		170		
		(write)		130		
		8-bit bus (read)	LC[7:6]=10b	100		
		(write)	LC[7:6]=01b	80		
				90		
t _{PWR80}	WR1	Pulse width 16-bit (read)		85	-	nS
		8-bit		50		
t _{PWW80}	WR0	Pulse width 16-bit (write)		65	-	nS
		8-bit	LC[7:6]=10b	40		
			LC[7:6]=01b	45		
t _{HPW80}	WR0, WR1	High pulse width				nS
		16-bit bus (read)		85		
		(write)		65		
		8-bit bus (read)	LC[7:6]=10b	50		
		(write)	LC[7:6]=01b	40		
				45		
t _{DS80}	D0~D15	Data setup time		30	-	nS
t _{DH80}		Data hold time		0		
t _{ACC80}		Read access time	C _L = 100pF	-	60	nS
t _{OD80}		Output disable time		15	30	
t _{CSSA80}	CS1/CS0	Chip select setup time		5		nS
t _{CSh80}				5		

RESET TIMING

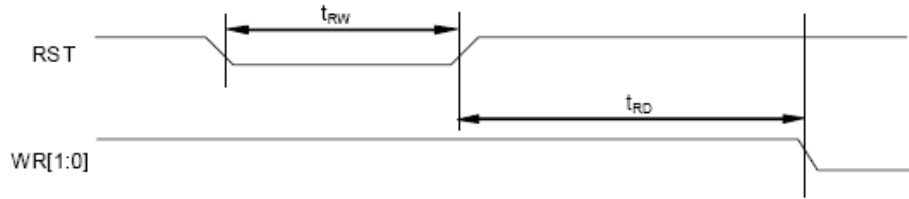

Reset Characteristics

($1.65V \leq V_{DD} < 3.3V$, $T_a = -30$ to $+85^\circ C$)

Symbol	Signal	Description	Condition	Min.	Max.	Units
t_{RW}	RST	Reset low pulse width		3	–	μS
t_{RD}	RST, WR	Reset to WR pulse delay		10	–	mS

9. CONTROL AND DISPLAY INSTRUCTION

The following is a list of host commands supported by UC1698u

C/D: 0: Control, 1: Data
 W/R: 0: Write Cycle, 1: Read Cycle
 #: Useful Data bits -: Don't Care

	Command	C/D	W/R	D7	D6	D5	D4	D3	D2	D1	D0	Action	Default	
1	Write Data Byte	1	0	#	#	#	#	#	#	#	#	Write 1 byte	N/A	
2	Read Data Byte	1	1	#	#	#	#	#	#	#	#	Read 1 byte	N/A	
3	Get Status & PM	0	1	GE	MX	MY	WA	DE	WS	MD	MS	Get {Status, Ver, PMO, Product Code, PID, MID}	N/A	
				PMO[6:0]										
4	Set Column Address LSB	0	0	0	0	0	0	#	#	#	#	Set CA[3:0]	0	
	Set Column Address MSB	0	0	0	0	0	1	0	#	#	#	Set CA[6:4]	0	
5	Set Temp. Compensation	0	0	0	0	1	0	0	1	#	#	Set TC[1:0]	0	
6	Set Power Control	0	0	0	0	1	0	1	0	#	#	Set PC[1:0]	10b	
7	Set Adv. Program Control (double-byte command)	0	0	0	0	1	1	0	0	0	R	Set APC[R][7:0], R = 0 or 1	N/A	
		0	0	#	#	#	#	#	#	#	#			
8	Set Scroll Line LSB	0	0	0	1	0	0	#	#	#	#	Set SL[3:0]	0	
	Set Scroll Line MSB	0	0	0	1	0	1	#	#	#	#	Set SL[7:4]	0	
9	Set Row Address LSB	0	0	0	1	1	0	#	#	#	#	Set RA[3:0]	0	
	Set Row Address MSB	0	0	0	1	1	1	#	#	#	#	Set RA[7:4]	0	
10	Set V _{BIAS} Potentiometer (double-byte command)	0	0	1	0	0	0	0	0	0	1	Set PM[7:0]	40H	
		0	0	#	#	#	#	#	#	#	#			
11	Set Partial Display Control	0	0	1	0	0	0	0	1	0	#	Set LC[8]	0	
12	Set RAM Address Control	0	0	1	0	0	0	1	#	#	#	Set AC[2:0]	001b	
13	Set Fixed Lines	0	0	1	0	0	1	0	0	0	0	Set {FLT, FLB}	0	
		0	0	#	#	#	#	#	#	#	#			
14	Set Line Rate	0	0	1	0	1	0	0	0	#	#	Set LC[4:3]	10b	
15	Set All-Pixel-ON	0	0	1	0	1	0	0	1	0	#	Set DC[1]	0	
16	Set Inverse Display	0	0	1	0	1	0	0	1	1	#	Set DC[0]	0	
17	Set Display Enable	0	0	1	0	1	0	1	#	#	#	Set DC[4:2]	110b	
18	Set LCD Mapping Control	0	0	1	1	0	0	0	#	#	#	Set LC[2:0]	0	
19	Set N-Line Inversion	0	0	1	1	0	0	1	0	0	0	Set NIV[4:0]	1DH	
		0	0	-	-	-	#	#	#	#	#			
20	Set Color Pattern	0	0	1	1	0	1	0	0	0	#	Set LC[5]	0 (BGR)	
21	Set Color Mode	0	0	1	1	0	1	0	1	#	#	Set LC[7:6]	10b	
22	Set COM Scan Function	0	0	1	1	0	1	1	#	#	#	Set CSF[2:0]	000b	
23	System Reset	0	0	1	1	1	0	0	0	1	0	System Reset	N/A	
24	NOP	0	0	1	1	1	0	0	0	1	1	No operation	N/A	
25	Set Test Control (double-byte command)	0	0	1	1	1	0	0	1	TT		For testing only. Do not use.	N/A	
		0	0	#	#	#	#	#	#	#	#			
26	Set LCD Bias Ratio	0	0	1	1	1	0	1	0	#	#	Set BR[1:0]	11b: 12	
27	Set COM End	0	0	1	1	1	1	0	0	0	1	Set CEN[6:0]	159	
		0	0	-	#	#	#	#	#	#	#			
28	Set Partial Display Start	0	0	1	1	1	1	0	0	1	0	Set DST[6:0]	0	
		0	0	-	#	#	#	#	#	#	#			
29	Set Partial Display End	0	0	1	1	1	1	0	0	1	1	Set DEN[6:0]	159	
		0	0	-	#	#	#	#	#	#	#			
30	Set Window Program Starting Column Address	0	0	1	1	1	1	0	1	0	0	Shared with MTP commands	Set WPC0	0
		0	0	-	#	#	#	#	#	#	#		Set WPP0	0
31	Set Window Program Starting Row Address	0	0	1	1	1	1	0	1	0	1	Shared with MTP commands	Set WPC1	127
		0	0	#	#	#	#	#	#	#	#		Set WPP1	159
32	Set Window Program Ending Column Address	0	0	1	1	1	1	0	1	1	0	Shared with MTP commands	Set WPC1	127
		0	0	-	#	#	#	#	#	#	#		Set WPP1	159
33	Set Window Program Ending Row Address	0	0	1	1	1	1	0	1	1	1	Shared with MTP commands	Set WPC1	127
		0	0	#	#	#	#	#	#	#	#		Set WPP1	159
34	Window Program Mode	0	0	1	1	1	1	1	0	0	#	Set AC[3]	0: Inside	
35	Set MTP Operation control	0	0	1	0	1	1	1	0	0	0	Set MTPC[4:0]	10H	
		0	0	-	-	-	#	#	#	#	#			

	Command	C/D	W/R	D7	D6	D5	D4	D3	D2	D1	D0	Action	Default	
36	Set MTP Write Mask	0 0 0	0 0 0	1 - -	0 # -	1 # -	1 # -	1 # -	0 # -	0 # -	1 # -	Set MTPM[6:0] MTPM1[1:0]	0	
37	Set V _{MTP1} Potentiometer	0 0	0 0	1 #	1 #	1 #	1 #	0 #	1 #	0 #	0 #	Shared with Window Program commands	Set MTP1	N/A
38	Set V _{MTP2} Potentiometer	0 0	0 0	1 #	1 #	1 #	1 #	0 #	1 #	0 #	1 #		Set MTP2	N/A
39	Set MTP Write Timer	0 0	0 0	1 #	1 #	1 #	1 #	0 #	1 #	1 #	0 #		Set MTP3	N/A
40	Set MTP Read Timer	0 0	0 0	1 #	1 #	1 #	1 #	0 #	1 #	1 #	1 #		Set MTP4	N/A

NOTE:

- All other bit patterns other than commands listed above may result in undefined behavior.
- The interpretation of commands (36)~(40) depends on the setting of register MTPC[3].
 - Commands (37)~(40) are shared with commands (30)~(33). These two sets of commands share exactly the same code and control registers. When MTPC[3]=0, they are interpreted as Window Program commands and registers. When MTPC[3]=1, they function as MTP Control commands and registers.
- After MTP ERASE or PROGRAM operation, before resuming normal operation, please always
 - a) Remove TST4 power source,
 - b) Do a full V_{DD} ON-OFF-ON cycle.
- Under 16-bit bus mode and CD=0, D[15:8] is ignored and only D[7:0] is used. As a result, the bus cycles for commands under 16-bit bus and 8-bit bus are the same, and double-byte commands still need two bus cycles under 16-bit bus mode.

Example:

8-bit bus mode:

Set PL[1:0] = 2'b11 : D[7:0] = 0010 1011

Set PM[7:0] = 8'h8b : 1st D[7:0] = 1000 0001

2nd D[7:0] = 1000 1011

16-bit bus mode:

Set PL[1:0] = 2'b11: D[15:0] = 0000 0000 0010 1011

Set PM[7:0] = 8'h8b: 1st D[15:0] = 0000 0000 1000 0001

2nd D[15:0] = 0000 0000 1000 1011

10. ELECTRO-OPTICAL CHARACTERISTICS

(V_{DD} = 3.3V, Ta = 25°C)

Item	Symbol	Condition	Min	Typ	Max	Unit
Operating Voltage for LCD	V _{op}	Ta = -20°C	16.2	16.5	16.8	V
		Ta = 25°C	15.7	16.0	16.3	
		Ta = 70°C	15.2	15.5	15.8	
Response Time	Tr	Ta = 25°C	---	250	500	ms
	Tf		---	300	600	ms
Contrast	Cr	Ta = 25°C	2	4	---	---
Viewing Angle Range	θ	Cr ≥ 2	-35	---	+35	deg
	Φ		-35	---	+40	deg

The following charts is for your reference of the data in the above form.

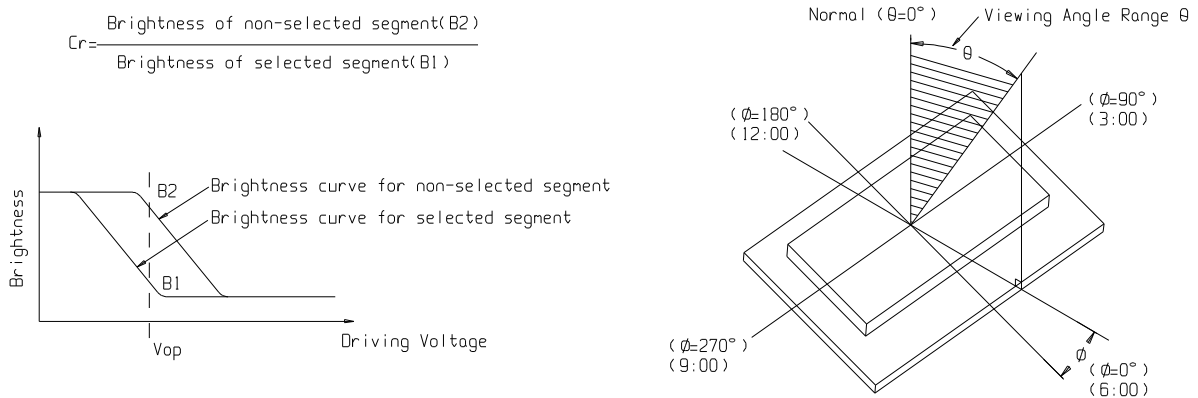

11. BACK LIGHT CHARACTERISTICS

LCD Module with edge LED Backlight. Electrical ratings. Ta = 25°C

Item	Symbol	Condition	Min	Typ	Max	Unit
Forward Current	IF	VF=3.5V		105	140	mA
Reverse Current	IR	VR=5.0V	---	---	70	uA
Luminous Intensity (With LCD dots off)	Lv	VF=3.5V	250	300	---	cd/m ²
Wave Length	λp	VF=3.5V	X=0.26 Y=0.26	---	X=0.30 Y=0.30	
Color			white			

Note:

when the temperature exceed 25°C, the approved current decrease rate for Backlight change as the temperature increase is: -0.36*7mA/°C (below 25°C, the current refer to constant, which would not change with temperature).

12. PRECAUTION FOR USING LCD/LCM

After reliability test, recovery time should be 24 hours minimum. Moreover, functions, performance and appearance shall be free from remarkable deterioration within 50,000 hours (average) under ordinary operating and storage conditions room temperature ($20\pm 8^{\circ}\text{C}$), normal humidity (below 65% RH), and in the area not exposed to direct sun light. Using LCM beyond these conditions will shorten the life time.

Precaution for using LCD/LCM

LCD/LCM is assembled and adjusted with a high degree of precision. Do not attempt to make any alteration or modification. The followings should be noted.

General Precautions:

1. LCD panel is made of glass. Avoid excessive mechanical shock or applying strong pressure onto the surface of display area.
2. The polarizer used on the display surface is easily scratched and damaged. Extreme care should be taken when handling. To clean dust or dirt off the display surface, wipe gently with cotton, or other soft material soaked with isopropyl alcohol, ethyl alcohol or trichlorotrifluoroethane, do not use water, ketone or aromatics and never scrub hard.
3. Do not tamper in any way with the tabs on the metal frame.
4. Do not make any modification on the PCB without consulting DISPLAY.
5. When mounting a LCM, make sure that the PCB is not under any stress such as bending or twisting. Elastomer contacts are very delicate and missing pixels could result from slight dislocation of any of the elements.
6. Avoid pressing on the metal bezel, otherwise the elastomer connector could be deformed and lose contact, resulting in missing pixels and also cause rainbow on the display.
7. Be careful not to touch or swallow liquid crystal that might leak from a damaged cell. Any liquid crystal adheres to skin or clothes, wash it off immediately with soap and water.

Static Electricity Precautions:

1. CMOS-LSI is used for the module circuit; therefore operators should be grounded whenever he/she comes into contact with the module.
2. Do not touch any of the conductive parts such as the LSI pads; the copper leads on the PCB and the interface terminals with any parts of the human body.
3. Do not touch the connection terminals of the display with bare hand; it will cause disconnection or defective insulation of terminals.
4. The modules should be kept in anti-static bags or other containers resistant to static for storage.
5. Only properly grounded soldering irons should be used.
6. If an electric screwdriver is used, it should be grounded and shielded to prevent sparks.

7. The normal static prevention measures should be observed for work clothes and working benches.
8. Since dry air is inductive to static, a relative humidity of 50-60% is recommended.

Soldering Precautions:

1. Soldering should be performed only on the I/O terminals.
2. Use soldering irons with proper grounding and no leakage.
3. Soldering temperature: $350^{\circ}\text{C}\pm 10^{\circ}\text{C}$
4. Soldering time: 3 to 4 second.
5. Use eutectic solder with resin flux filling.
6. If flux is used, the LCD surface should be protected to avoid spattering flux.
7. Flux residue should be removed.

Operation Precautions:

1. The viewing angle can be adjusted by varying the LCD driving voltage V_o .
2. Since applied DC voltage causes electro-chemical reactions, which deteriorate the display, the applied pulse waveform should be a symmetric waveform such that no DC component remains. Be sure to use the specified operating voltage.
3. Driving voltage should be kept within specified range; excess voltage will shorten display life.
4. Response time increases with decrease in temperature.
5. Display color may be affected at temperatures above its operational range.
6. Keep the temperature within the specified range usage and storage. Excessive temperature and humidity could cause polarization degradation, polarizer peel-off or generate bubbles.
7. For long-term storage over 40°C is required, the relative humidity should be kept below 60%, and avoid direct sunlight.

Limited Warranty

DISPLAY LCDs and modules are not consumer products, but may be incorporated by DISPLAY's customers into consumer products or components thereof, DISPLAY does not warrant that its LCDs and components are fit for any such particular purpose.

1. The liability of DISPLAY is limited to repair or replacement on the terms set forth below. DISPLAY will not be responsible for any subsequent or consequential events or injury or damage to any personnel or user including third party personnel and/or user. Unless otherwise agreed in writing between DISPLAY and the customer, DISPLAY will only replace or repair any of its LCD which is found defective electrically or visually when inspected in accordance with DISPLAY general LCD inspection standard . (Copies available on request)
2. No warranty can be granted if any of the precautions state in handling liquid crystal display above has been disregarded. Broken glass, scratches on polarizer mechanical damages as well as defects that are caused accelerated environment tests are excluded from warranty.
3. In returning the LCD/LCM, they must be properly packaged; there should be detailed description of the failures or defect.