

Display Elektronik GmbH

DATA SHEET

TFT MODULE

**DEM 800480U TMH-PW-N
(C-TOUCH)**

5,0“ TFT + PCT

Product Specification

Ver.: 2.1.1

22.10.2019

Revision History

VERSION	DATE	REVISED PAGE NO.	Note
0	23.10.2017		First Issue
1	02.11.2017		Add LED Lifetime
2	30.01.2018		Modify Temperature
2.1.0	27.06.2019		General Change
2.1.1	22.10.2019		Modify Electrical Characteristics (Note2&IDD)

Contents

1. Summary
2. General Specification
3. Interface
4. Counter Drawing
5. Absolute Maximum Ratings
6. Electrical Characteristics
7. DC Characteristics
8. Optical Characteristics
9. Reliability

1. Summary

TFT 5.0" is a TN transmissive type color active matrix TFT liquid crystal display that use amorphous silicon TFT as switching devices. This module is a composed of a TFT LCD module. It is usually designed for industrial application and this module follows RoHS.

2. General Specifications

- n Size: 5.0 Inch
- n Dot Matrix: 800 x RGB x 480 Dots
- n Module Dimension: 120.70 x 75.80 x 23.20 mm
- n Active Area: 108.00 x 64.80 mm
- n Dot Pitch: 0.045 x 0.135 mm
- n LCD Type: TFT, Normally White TN, Transmissive
- n View Direction: 12 O'Clock
- n Gray Scale Inversion Direction: 6 O'Clock
- n Aspect Ratio: 16:9
- n Backlight Type: LED, Normally White
- n Controller IC: TFP401
- n Interface: HDMI
- n With /Without TP: With Capacitive Touch
- n CTP IC: FT5426 Or Equal
- n CTP Interface: USB
- n CTP FW Version: 2
- n Surface: Glare

*Color tone slight changed by temperature and driving voltage.

3. Interface

3.1. LCM PIN Definition (CON5)

Pin	Symbol	Function	Remark
1	3.3V	TFT Module Power limit can only output 3.3V,100mA	NOTE1
2	5V	Raspberry Pi:Power 5V	
3	GPIO02	Raspberry Pi:GPIO02	
4	5V	Raspberry Pi:Power 5V	
5	GPIO03	Raspberry Pi:GPIO03	
6	GND	Raspberry Pi:GND	
7	GPIO04	Raspberry Pi:GPIO04	
8	GPIO14	Raspberry Pi:GPIO14	
9	GND	Raspberry Pi:GND	
10	GPIO15	Raspberry Pi:GPIO15	
11	GPIO17	Raspberry Pi:GPIO17	
12	GPIO18	Raspberry Pi:GPIO18 (Backlight Enable)	
13	GPIO27	Raspberry Pi:GPIO27	
14	GND	Raspberry Pi:GND	
15	GPIO22	Raspberry Pi:GPIO22	
16	GPIO23	Raspberry Pi:GPIO23	
17	3.3V	TFT Module Power limit can only output 3.3V,100mA	NOTE1
18	GPIO24	Raspberry Pi:GPIO24	
19	GPIO10	Raspberry Pi:GPIO10	
20	GND	Raspberry Pi:GND	
21	GPIO09	Raspberry Pi:GPIO09	
22	GPIO25	Raspberry Pi:GPIO25	
23	GPIO11	Raspberry Pi:GPIO11	
24	GPIO08	Raspberry Pi:GPIO08	
25	GND	Raspberry Pi:GND	
26	GPIO07	Raspberry Pi:GPIO07	
27	ID_SD	Raspberry Pi:ID_SD	
28	ID_SC	Raspberry Pi:ID_SC	
29	GPIO05	Raspberry Pi:GPIO05	
30	GND	Raspberry Pi:GND	
31	GPIO06	Raspberry Pi:GPIO06	
32	GPIO12	Raspberry Pi:GPIO12	
33	GPIO13	Raspberry Pi:GPIO13	
34	GND	Raspberry Pi:GND	
35	GPIO19	Raspberry Pi:GPIO19	
36	GPIO16	Raspberry Pi:GPIO16	
37	GPIO26	Raspberry Pi:GPIO26	
38	GPIO20	Raspberry Pi:GPIO20	
39	GND	Raspberry Pi:GND	
40	GPIO21	Raspberry Pi:GPIO21	

Note1: The 3.3V supply current is limited; please pay special attention to use

3.2 LCM PIN Definition (CON4)

Pin	Symbol	Function	Remark
1	NC	No connection	
2	5V	Raspberry Pi:Power 5V	
3	GPIO02	Raspberry Pi:GPIO02	
4	5V	Raspberry Pi:Power 5V	
5	GPIO03	Raspberry Pi:GPIO03	
6	GND	Raspberry Pi:GND	
7	GPIO04	Raspberry Pi:GPIO04	
8	GPIO14	Raspberry Pi:GPIO14	
9	GND	Raspberry Pi:GND	
10	GPIO15	Raspberry Pi:GPIO15	
11	GPIO17	Raspberry Pi:GPIO17	
12	GPIO18	Raspberry Pi:GPIO18 (Backlight Enable)	
13	GPIO27	Raspberry Pi:GPIO27	
14	GND	Raspberry Pi:GND	
15	GPIO22	Raspberry Pi:GPIO22	
16	GPIO23	Raspberry Pi:GPIO23	
17	NC	No connection	
18	GPIO24	Raspberry Pi:GPIO24	
19	GPIO10	Raspberry Pi:GPIO10	
20	GND	Raspberry Pi:GND	
21	GPIO09	Raspberry Pi:GPIO09	
22	GPIO25	Raspberry Pi:GPIO25	
23	GPIO11	Raspberry Pi:GPIO11	
24	GPIO08	Raspberry Pi:GPIO08	
25	GND	Raspberry Pi:GND	
26	GPIO07	Raspberry Pi:GPIO07	
27	ID_SD	Raspberry Pi:ID_SD	
28	ID_SC	Raspberry Pi:ID_SC	
29	GPIO05	Raspberry Pi:GPIO05	
30	GND	Raspberry Pi:GND	
31	GPIO06	Raspberry Pi:GPIO06	
32	GPIO12	Raspberry Pi:GPIO12	
33	GPIO13	Raspberry Pi:GPIO13	
34	GND	Raspberry Pi:GND	
35	GPIO19	Raspberry Pi:GPIO19	
36	GPIO16	Raspberry Pi:GPIO16	
37	GPIO26	Raspberry Pi:GPIO26	
38	GPIO20	Raspberry Pi:GPIO20	
39	GND	Raspberry Pi:GND	
40	GPIO21	Raspberry Pi:GPIO21	

3.3. CTP USB PIN Definition (CON3)

Pin	Symbol	Function	Remark
1	5V	Power 5V	
2	D-	Data line -	
3	D+	Data line +	
4	NC	No connection	
5	GND	Power Ground	

3.4. HDMI

Pin No.	Symbol	I/O	Function	Remark
1	Rx2+	I	+LVDS Differential Data Input	
2	GND	P	Ground	
3	Rx2-	I	-LVDS Differential Data Input	
4	Rx1+	I	+LVDS Differential Data Input	
5	GND	P	Ground	
6	Rx1-	I	-LVDS Differential Data Input	
7	Rx0+	I	+LVDS Differential Data Input	
8	GND	P	Ground	
9	Rx0-	I	-LVDS Differential Data Input	
10	RxC+	I	+LVDS Differential Clock Input	
11	GND	P	Ground	
12	RxC-	I	-LVDS Differential Clock Input	
13-14	NC	-	No connection	
15	SCL	I/O	DDC(Data Display Channel) Clock	
16	SDA	I/O	DDC(Data Display Channel) Data	
17	GND	P	Ground	
18	5V	P	Power Supply	
19	Detect	I/O	Hot plug detect	

I: input, O: output, P: Power

4. Counter Drawing

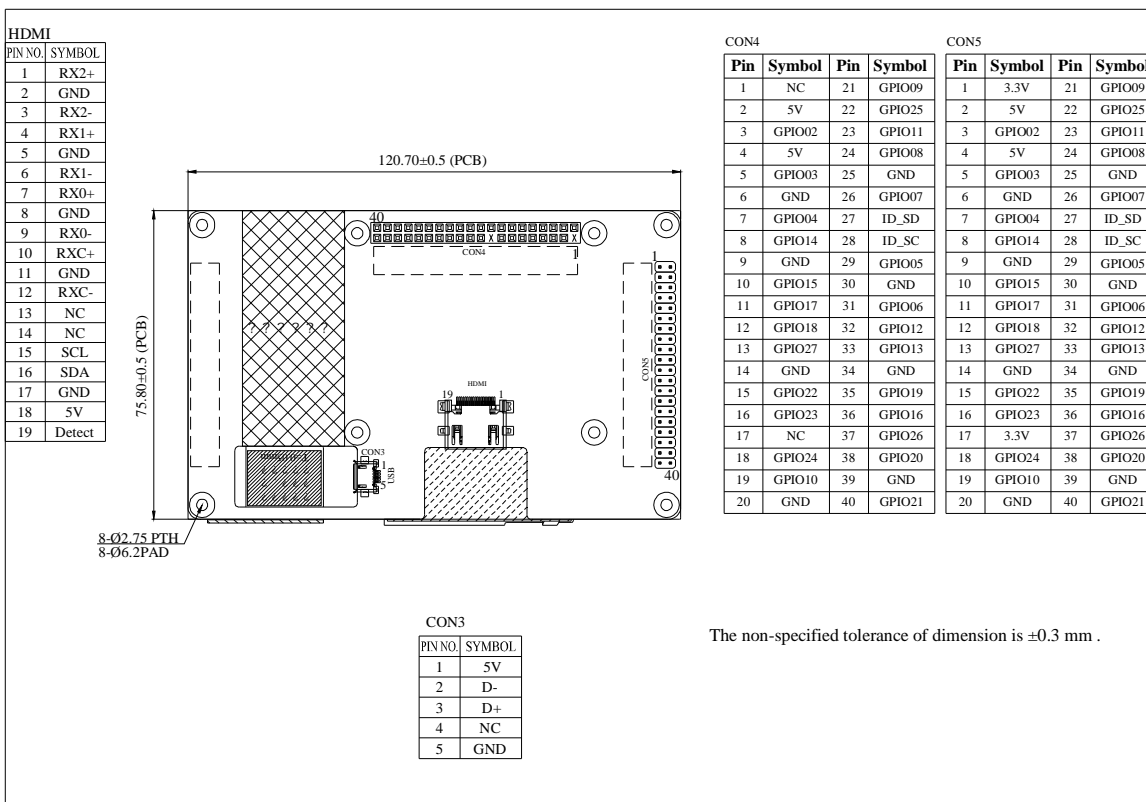
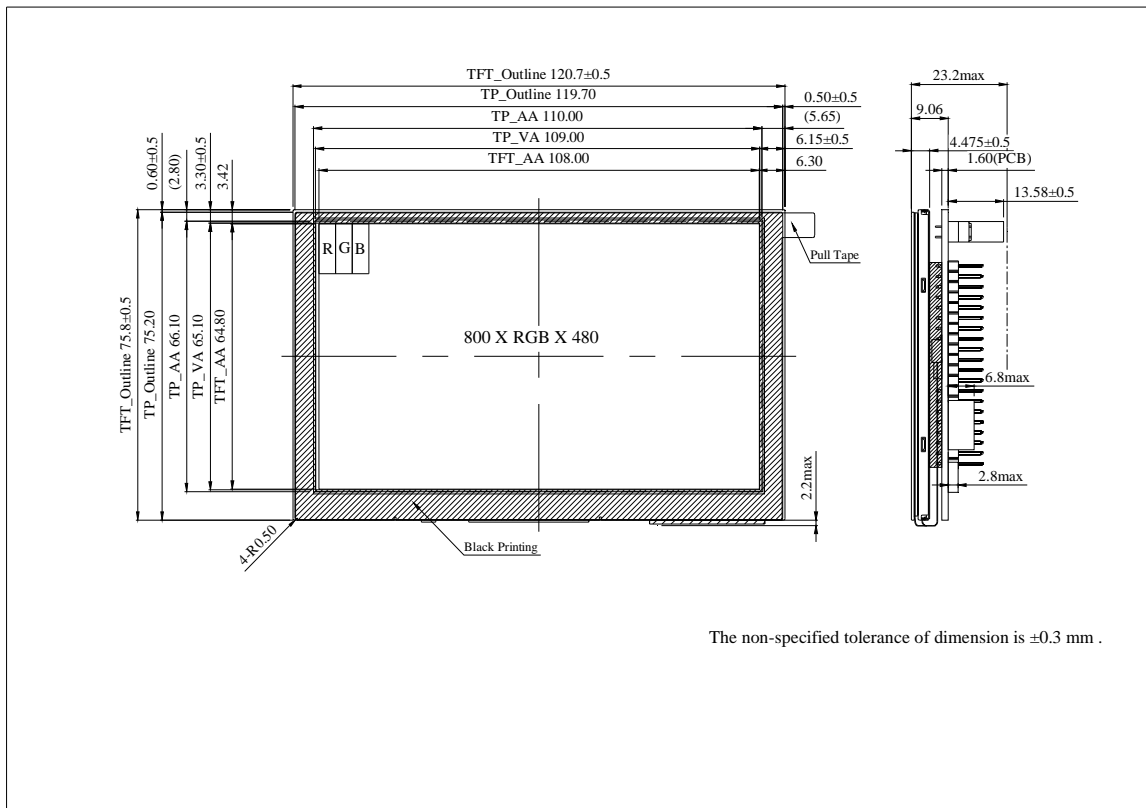

5. Absolute Maximum Ratings

Item	Symbol	Min	Typ	Max	Unit
Operating Temperature	T _{OP}	-20	-	+70	°C
Storage Temperature	T _{ST}	-30	-	+80	°C

Note: Device is subject to be damaged permanently if stresses beyond those absolute maximum ratings listed above

1. Temp. $\leq +60^{\circ}\text{C}$, 90% RH MAX. Temp. $> +60^{\circ}\text{C}$, Absolute humidity shall be less than 90% RH at $+60^{\circ}\text{C}$

6. Electrical Characteristics

6.1. Operating conditions:

Item	Symbol	Condition	Min	Typ	Max	Unit	Remark
Supply Voltage For LCM	VDD	-	4.9	5	5.1	V	-
Supply Current For LCM	IDD	-	-	450	680	mA	Note 1
LED Lifetime	-	-	-	50,000	-	Hr	Note 4

Note 1: This value is test for VDD =5.0V, Ta=+25°C only

Note 2: Please make sure to support enough current.

Note 3: CTP driver is base on the mouse driver program and through USB port connect to PC or embedded board. Can only support the single touch.

Note 4: Note 4: The “LED life time” is defined as the module brightness decrease to 50% original brightness at Ta=25°C and IL =60mA. The LED lifetime could be decreased if operating IL is larger than 60mA.

7. DC CHARATERISTICS

Parameter	Symbol	Rating			Unit	Condition
		Min	Typ	Max		
Low Level Input Voltage	V_{IL}	0	-	0.3VDD	V	
High Level Input Voltage	V_{IH}	0.7VDD	-	VDD	V	

8. Optical Characteristics

Item	Symbol	Condition.	Min	Typ.	Max.	Unit	Remark	
Response Time	Tr	$\theta=0^\circ, \Phi=0^\circ$	-	10	20	.ms	Note 3	
	Tf		-	15	30	.ms		
Contrast Ratio	CR	At optimized viewing angle	400	500	-	-	Note 4	
Color Chromaticity	White	Wx	$\theta=0^\circ, \Phi=0^\circ$	0.26	0.31	0.36		Note 2,6,7
		Wy		0.28	0.33	0.38		
Viewing Angle (Gray Scale Inversion Direction)	Hor.	Θ_R	$CR \geq 10$	60	70	-	Deg.	Note 1
		Θ_L		60	70	-		
	Ver.	Φ_T		40	50	-		
		Φ_B		60	70	-		
Brightness	-	-	300	400	-	cd/m ²	Center of display	
Uniformity	(U)	-	75	-	-	%	Note 5	

Ta=+25°C±2°C

Note 1: Definition of viewing angle range

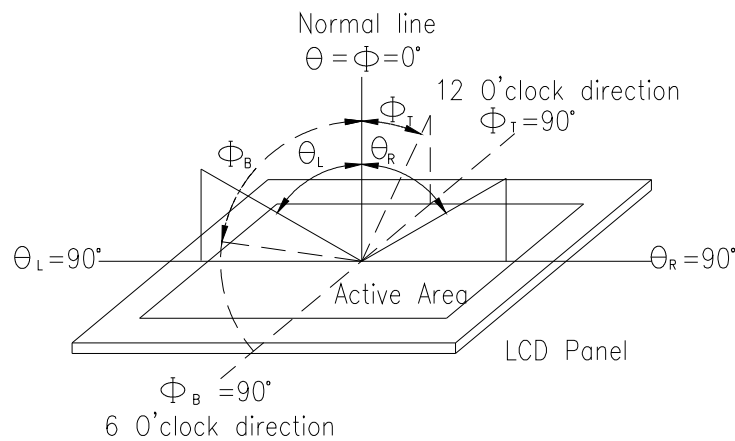

Fig. 8.1. Definition of viewing angle

Note 2: Test equipment setup:

After stabilizing and leaving the panel alone at a driven temperature for 10 minutes, the measurement should be executed. Measurement should be executed in a stable, windless, and dark room. Optical specifications are measured by Topcon BM-7or BM-5 luminance meter 1.0° field of view at a distance of 50cm and normal direction.

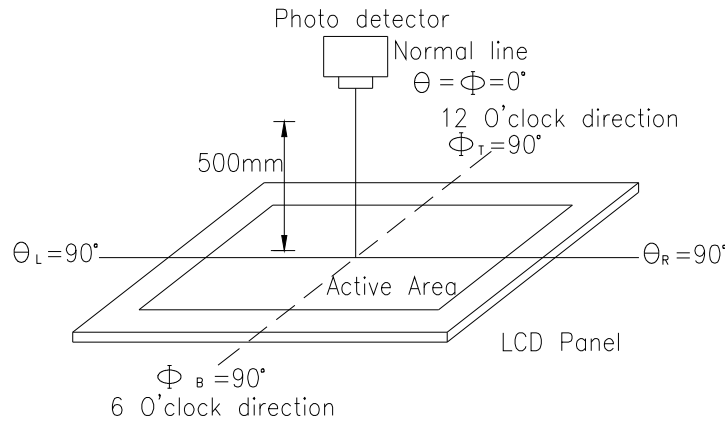
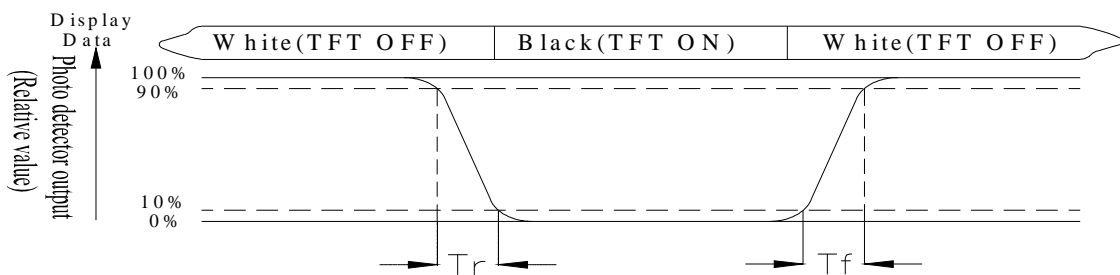

Fig. 8.2. Optical measurement system setup

Note 3: Definition of Response time:

The response time is defined as the LCD optical switching time interval between “White” state and “Black” state. Rise time, Tr, is the time between photo detector output intensity changed from 90%to 10%. And fall time, Tf, is the time between photo detector output intensity changed from 10%to 90%



Note 4: Definition of contrast ratio:

The contrast ratio is defined as the following expression.

$$\text{Contrast ratio (CR)} = \frac{\text{Luminance measured when LCD on the "White" state}}{\text{Luminance measured when LCD on the "Black" state}}$$

Note 5: Definition of Luminance Uniformity

Active area is divided into 9 measuring areas (reference the picture in below). Every measuring point is placed at the center of each measuring area.

$$\text{Luminance Uniformity (U)} = L_{\text{min}}/L_{\text{max}} \times 100\%$$

L = Active area length

W = Active area width

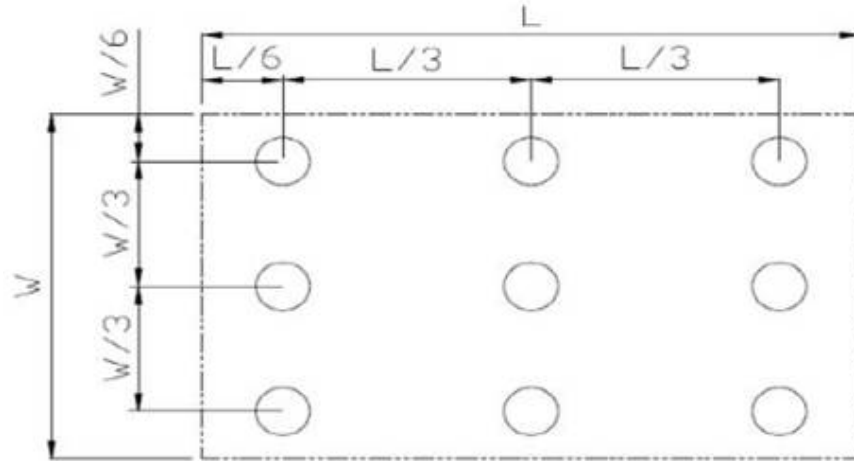

Fig. 8.3. Definition of uniformity

Note 6: Definition of color chromaticity (CIE 1931)

Color coordinates measured at the center point of LCD

Note 7: Measured at the center area of the panel when all the input terminals of LCD panel are electrically opened.

9. Reliability

Content of Reliability Test (Wide temperature, -20°C~+70°C)

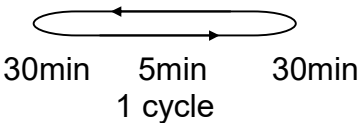
Environmental Test			
Test Item	Content of Test	Test Condition	Note
High Temperature storage	Endurance test applying the high storage temperature for a long time.	+80°C 200hrs	2
Low Temperature storage	Endurance test applying the low storage temperature for a long time.	-30°C 200hrs	1,2
High Temperature Operation	Endurance test applying the electric stress (Voltage & Current) and the thermal stress to the element for a long time.	+70°C 200hrs	—
Low Temperature Operation	Endurance test applying the electric stress under low temperature for a long time.	-20°C 200hrs	1
High Temperature/ Humidity Operation	The module should be allowed to stand at +60°C,90%RH max	+60°C,90%RH 96hrs	1,2
Thermal shock resistance	The sample should be allowed stand the following 10 cycles of operation <div style="text-align: center;">  <p>30min 5min 30min 1 cycle</p> </div>	-20°C/+70°C 10 cycles	—
Vibration test	Endurance test applying the vibration during transportation and using.	Total fixed amplitude : 1.5mm Vibration Frequency : 10~55Hz One cycle 60 seconds to 3 directions of X,Y,Z for Each 15 minutes	3
Static electricity test	Endurance test applying the electric stress to the terminal.	VS=±600V(Contact) ±800V(Air), RS=330Ω CS=150pF 10 times	—

Note1: No dew condensation to be observed.

Note2: The function test shall be conducted after 4 hours storage at the normal Temperature and humidity after remove from the test chamber.

Note3: The packing have to including into the vibration testing.