

**FEATURES**

- Output: 4 channels
- BUS+SEQUENCER+FADER+DIMMER+DRIVER
- Input: DC 12/24/48 Vdc
- BUS Command: DMX512-A+RDM, DALI, MODBUS
- LOCAL Command: 4x N.O. push button (with or without memory), 0-10V, 1-10V and Potentiometer 10KOhm
- Controls: Dimmer, Dim to Warm, Tunable White, RGB, RGBW
- Control outputs and Current outputs for R-L-C loads
- Typical efficiency > 95%
- Adjusting the brightness up to completed off (Dim to Dark)
- Level minimum of brightness: 0.1% (1% in push)
- D-PWM Modulation
- Adjusting D-PWM frequency: 300 / 600 / 1200 Hz
- Adjusting output curve: Linear / Quadratic / Exponential
- Soft start and soft stop
- Soft dimming regulation
- Master / Slave Function (DMX variant)
- Extended temperature range
- 100% Functional test – 5 years warranty

→ For the whole and update Device Manual refer to producer's website: <http://www.dalcnet.com>

➤ **CONSTANT CURRENT VARIANTS (common anode)**

Application (4 – channels output): Dimmer, Dim to warm, Tunable White, RGB, RGBW

CODE	Supply Voltage	Output	Channels	Command	
DLD1248-4CC-DMX	12-48V DC	1x1000-2800 mA	4	DMX N.O. push button / 0-10 / 1-10 / Pot 10kΩ	PROFESSIONAL
		4x250-700 mA			
DLD1248-4CC-MODBUS	12-48V DC	1x1000-2800 mA	4	MODBUS RTU N.O. push button / 0-10 / 1-10 / Pot 10kΩ	PROFESSIONAL
		4x250-700 mA			
DLD1248-4CC-DALI	12-48V DC	1x1000-2800 mA	4	DALI N.O. push button / 0-10 / 1-10 / Pot 10kΩ	PROFESSIONAL
		4x250-700 mA			

➤ **CONSTANT VOLTAGE VARIANTS (common anode)**

Application (4 – channels output): Dimmer, Dim to warm, Tunable White, RGB, RGBW

CODE	Supply Voltage	Output	Channels	Command	
DLD1248-4CV-DMX	12-48V DC	1x20A max	4	DMX N.O. push button / 0-10 / 1-10 / Pot 10kΩ	PROFESSIONAL
		4x5A max			
DLD1248-4CV-MODBUS	12-48V DC	1x20A max	4	MODBUS RTU N.O. push button / 0-10 / 1-10 / Pot 10kΩ	PROFESSIONAL
		4x5A max			
DLD1248-4CV-DALI	12-48V DC	1x20A max	4	DALI N.O. push button / 0-10 / 1-10 / Pot 10kΩ	PROFESSIONAL
		4x5A max			

## ➤ PROTECTIONS

		DLD1248-4CV	DLD1248-4CC
<b>OTP</b>	Over temperature protection <sup>1</sup>	✓	✓
<b>OVP</b>	Over voltage protection <sup>2</sup>	✓	✓
<b>UVP</b>	Under voltage protection <sup>2</sup>	✓	✓
<b>RVP</b>	Reverse polarity protection <sup>2</sup>	✓	✓
<b>IFP</b>	Input fuse protection <sup>2</sup>	✓	✓
<b>SCP</b>	Short circuit protection	✓	✗
<b>OCP</b>	Open circuit protection	✗	✓
<b>CLP</b>	Current limit protection	✓	✓

## ➤ REFERENCE STANDARDS

EN 61347-1	Lamp controlgear - Part 1: General and safety requirements
EN 55015	Limits and methods of measurement of radio disturbance characteristics of electrical lighting and similar equipment
EN 61547	Equipment for general lighting purposes - EMC immunity requirements
EN 50581	Technical documentation for the assessment of electrical and electronic products with respect to the restriction of hazardous substances
IEC/EN 62386-101	Digital addressable lighting interface - Part 101: General requirements - System
IEC/EN 62386-102	Digital addressable lighting interface - Part 102: General requirements - Control gear
IEC/EN 62386-207	Digital addressable lighting interface - Part 207: Particular requirements for control gear – LED modules (device type 6)
IEC 60929-E.2.1	Control interface for controllable ballasts - control by d.c. voltage - functional specification
ANSI E 1.3	Entertainment Technology - Lighting Control Systems - 0 to 10V Analog Control Specification
ANSI E1.11	Entertainment Technology - USITT DMX512-A - Asynchronous Serial Digital Data Transmission Standard for Controlling Lighting Equipment and Accessories
ANSI E1.20	Entertainment Technology-RDM-Remote Device Management over USITT DMX512 Networks
-	MODBUS APPLICATION PROTOCOL SPECIFICATION V1.1b

<sup>1</sup> Thermal Protection on the output channel in case of high temperature. The thermal intervention is detected by transistor (>150°C) or current regulation (depending of the booster variant).

<sup>2</sup> Only control logic protection

## ➤ TECHNICAL SPECIFICATION CONSTANT VOLTAGE OUTPUT

		Variant Constant Voltage	
Supply Voltage		DC min: 10.8 Vdc .. max: 52.8 Vdc	
Output Voltage		= Vin	
Input Current		max 20A	
Output Current <sup>3</sup>		@ch	Total
		4x max 5 A	// 1 x max 20 A
Nominal Power <sup>3</sup>	@12V	60 W/ch	240 W tot
	@24V	120 W/ch	480 W tot
	@48V	240 W/ch	960 W tot

## ➤ TECHNICAL SPECIFICATION CONSTANT VOLTAGE OUTPUT

		Variant Constant Current									
Supply Voltage		DC min: 10.8 Vdc .. max: 52.8 Vdc									
Output Voltage		min: Vin/4 – max: Vin-0,9V									
Input Current		max 2,8 A									
Output Current <sup>3</sup>		@ch					Total				
		4x max 700 mA					// 1 x max 2,8 A				
Nominal Power @ at canna <sup>3</sup>	Current [mA]	250	300	350	400	450	500 <sup>4</sup>	550 <sup>4</sup>	600 <sup>4</sup>	650 <sup>4</sup>	700 <sup>4</sup>
	@12V	3W	3,6W	4,2W	4,8W	5,4W	6W	6,6W	7,2W	7,8W	8,4W
	@24V	6W	7,2W	8,4W	9,6W	10,8W	12W	13,2W	14,4W	15,6W	16,8W
	@48V	12W	14,4W	16,8W	19,2W	21,6W	24W	26,4W	28,8W	31,2W	33,6W
Single Output	Current [mA]	250	300	350	400	450	500	550	600	650	700
	@12V	12W	14,4W	16,8W	19,2W	21,6W	24W	26,4W	28,8W	31,2W	33,6W
	@24V	24W	28,8W	33,6W	38,4W	43,2W	48W	52,8W	57,6W	62,4W	67,2W
	@48V	48W	57,6W	67,2W	76,8W	86,4W	96W	105,6W	115,2W	124,8W	134,4W
Nominal Power <sup>3</sup>	Current [mA]	250	300	350	400	450	500	550	600	650	700
	@12V	12W	14,4W	16,8W	19,2W	21,6W	24W	26,4W	28,8W	31,2W	33,6W
	@24V	24W	28,8W	33,6W	38,4W	43,2W	48W	52,8W	57,6W	62,4W	67,2W
	@48V	48W	57,6W	67,2W	76,8W	86,4W	96W	105,6W	115,2W	124,8W	134,4W
Total Output	Current [mA]	250	300	350	400	450	500	550	600	650	700
	@12V	12W	14,4W	16,8W	19,2W	21,6W	24W	26,4W	28,8W	31,2W	33,6W
	@24V	24W	28,8W	33,6W	38,4W	43,2W	48W	52,8W	57,6W	62,4W	67,2W
	@48V	48W	57,6W	67,2W	76,8W	86,4W	96W	105,6W	115,2W	124,8W	134,4W

## ➤ TECHNICAL SPECIFICATION CONSTANT VOLTAGE OUTPUT

Power loss in standby mode	<500mW
Type Load	R – L – C
Thermal Shutdown <sup>5</sup>	150 °C
D-PWM Dimming Frequency	300Hz – 600Hz – 1200Hz
D-PWM Resolution	16 bit
D-PWM Range	0,1% - 100%
Storage Temperature	min: -40 max: +60 °C
Ambient Temperature	min: -40 max: +60 °C
Wiring	Buttons & Bus: 1.5 mm <sup>2</sup> solid - 1mm <sup>2</sup> stranded - 30/14 AWG Power & Leds: 2.5 mm <sup>2</sup> solid – 1.5mm <sup>2</sup> stranded - 30/12 AWG
Wire preparation length	Buttons & Bus: 6 mm Power & Leds: 7,5 mm
Protection Grade	IP10
Casing material	Plastic
Packaging unit (pieces/unit)	Single Carton Box - 1pz      Carton Box 4 pz
Mechanical Dimension	72 x 92 x 62 mm – DIN RAIL 4mod.
Packaging Dimension	124 x 85 x 71 mm      263 x 178 x 82 mm
Weight	125g      800g

<sup>3</sup> Maximum value, dependent on the ventilation conditions<sup>4</sup> The maximum output current depends on the operating conditions and the ambient temperature of the installation. For the correct configuration, check the maximum power that can be delivered in the ["Technical Specifications"](#).<sup>5</sup> Thermal Protection on the output channel in case of high temperature. The thermal intervention is detected by transistor (>150°C) or current regulation (depending of the booster variant).

➤ **INSTALLATION**

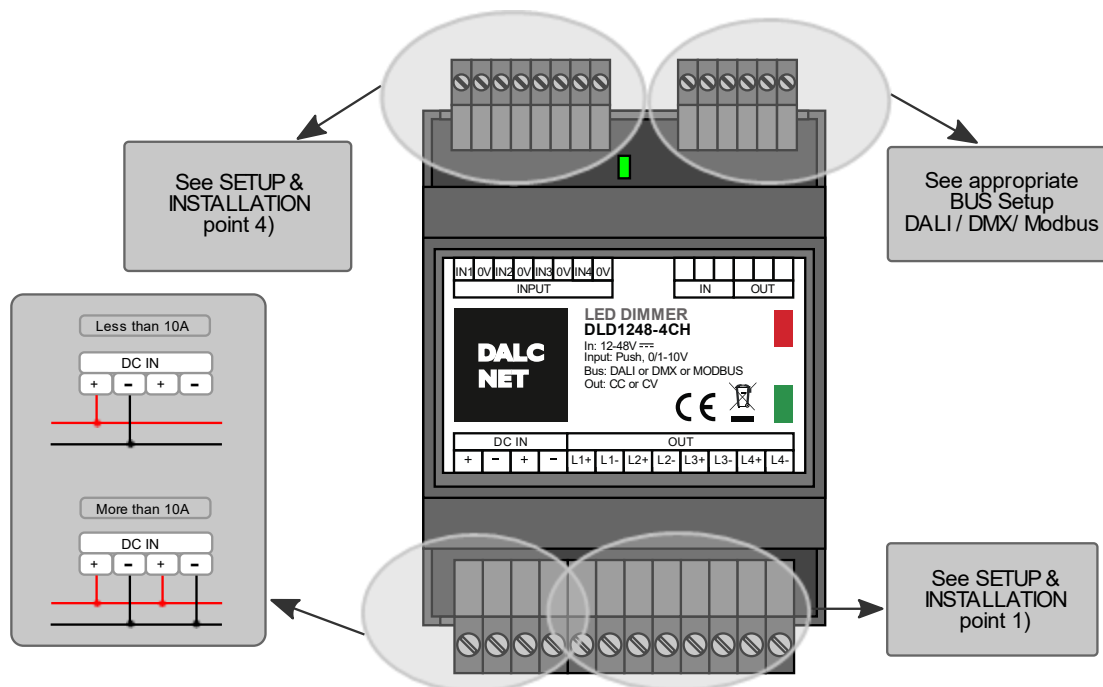

➤ **MECHANICAL DIMENSION**  
(without connector)

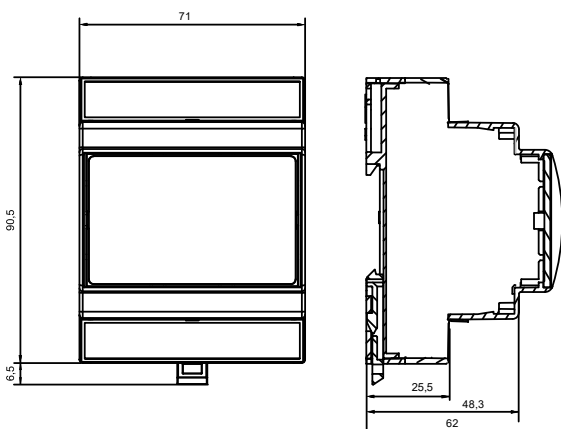

➤ **OPENING THE COVER**

For the Dip-switch and selectors configuration it is necessary to pull up the cover of the device. See the picture.

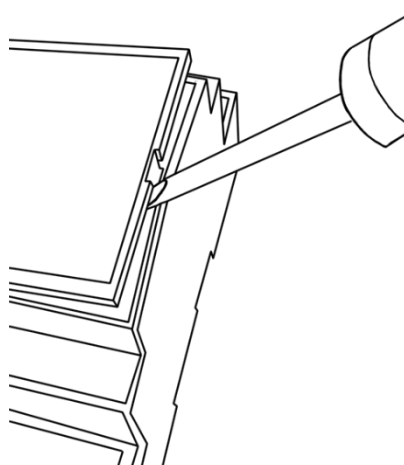

### ➤ OPERATING WINDOWS (Only Constant Current)

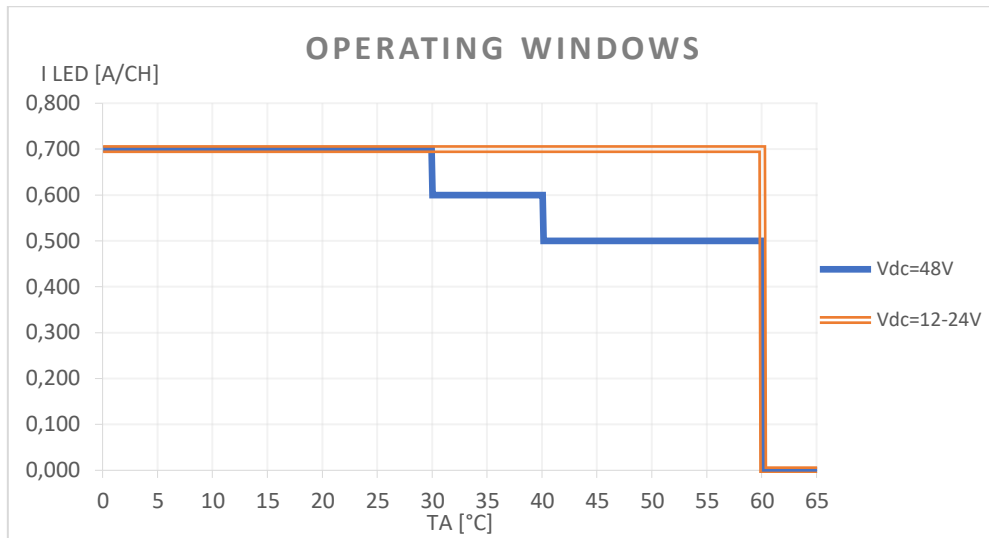

### ➤ TECHNICAL NOTES

#### Installation:

- Installation and maintenance must be performed only by qualified personnel in compliance with current regulations.
- The product must be installed inside an electrical panel protected against overvoltages.
- The product must be installed in a vertical or horizontal position with the cover / label upwards or vertically; Other positions are not permitted. It is not permitted to bottom-up position (with the cover / label down).
- Keep separated the circuits at 230V (LV) and the circuits not SELV from circuits to low voltage (SELV) and from any connection with this product. It is absolutely forbidden to connect, for any reason whatsoever, directly or indirectly, the 230V mains voltage to the bus or to other parts of the circuit.

#### Power supply:

- For the power supply use only a SELV power supplies with limited current, short circuit protection and the power must be dimensioned correctly. In case of using power supply with ground terminals, all points of the protective earth (PE = Protection Earth) must be connected to a valid and certified protection earth.
- The connection cables between the power source "low voltage" and the product must be dimensioned correctly and they should be isolated from every wiring or parts at voltage not SELV. Use double insulated cables.
- In the event of higher than 10A total output current to plug into both power input pairs "V+" and "V-".
- Dimension the power supply for the load connected to the device. If the power supply is oversized compared with the maximum absorbed current, insert a protection against over-current between the power supply and the device.
- For the constant current output, the voltage of LED module (Vf) must be less of 5V at the voltage of power supply.

#### Command:

- The length of the connection cables between the local commands (N.O. Push button, 0-10V, 1-10V, Potentiometer or other) and the product must be less than 10m; the cables must be dimensioned correctly and they should be isolated from every wiring or parts at voltage not SELV. Use double insulated shielded and twisted cables.
- The length and type of the connection cables at the BUS (DMX512, Modbus, DALI, Ethernet, or other) use cables as per specification of the respective protocols and regulations and they should be isolated from every wiring or parts at voltage not SELV. It is suggested to use double insulated shielded and twisted cables.
- All devices a related control signal to the bus (DMX512, Modbus, DALI, Ethernet or other) and at the local command (N.O. Push button, 0-10V, 1-10V, Potentiometer or other) must be SELV (the devices connected must be SELV or supply a SELV signal)

#### Outputs:

- It is suggesting the length of the connection cables between the product and the LED module must be less than 10m; the cables must be dimensioned correctly and they should be isolated from every wiring or parts at voltage not SELV. It is suggested to use double insulated shielded and twisted cables. In case you want to connection the product to LED modules with cables longer than 10m, the installer must guarantee the correct functioning of the system. In any case, do not exceed 30m of the connection between the product and the LED modules.



## ➤ SETUP & INSTALLATION

A 12 way dip-switch (under the cover) can provide a rich set of possible configurations:

Note: Factory positions = all OFF











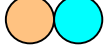











Function		<ul style="list-style-type: none"> <li>• Switches from 1 to 2: <b>Load Type</b></li> <li>• Switch 3: <b>Parallel Outputs</b></li> <li>• Switches from 4 to 6: <b>Map</b></li> <li>• Switches from 7 to 8: <b>Curve</b></li> <li>• Switches from 9 to 10: <b>Input Type</b></li> <li>• Switches from 11 to 12: <b>Output frame rate (freq.)</b></li> </ul>
----------	--	-----------------------------------------------------------------------------------------------------------------------------------------------------------------------------------------------------------------------------------------------------------------------------------------------------------------------------------------------------------

1) Select Load Type and Parallel Out depending on output connections: Switches from 1 to 2 and Switch 3





Load Type	Description	Connections (Total current 0 - 10A max)	Connections (Total current 0 - 20A max)	Settings
	White, up to 4 loads			
	White, parallel outputs with increased current (Macro dimmer)			
	Tunable White, up to 2 loads			
	Tunable White, parallel output pairs with increased current			
	RGB			
	RGBW			

Note: Set the "Select Map" according to the connected load and the function you want. See "Map Setting" page 7.

2) Select Map: Switches from 4 to 6

White Load 	Tunable White Load 	RGB Load 	RGBW Load 
Dimmer 	Dimmer 	Dimmer 	Dimmer 
	Dim to Warm 	Dim to Warm 	Dim to Warm 
	Tunable White 	Tunable White 	Tunable White 
		Smart HSV Intensity, temperature correction, color hue & rotation, saturation and strobe 	Smart HSV Intensity, temperature correction, color hue & rotation, saturation and strobe 
		RGB 	RGB Convert RGB→RGBW 
		RGBW Convert RGBW→RGB 	RGBW 
		Master+RGB+Strobe 	Master+RGB+Strobe Convert RGB→RGBW 
		Master+RGBW+Strobe Convert RGBW→RGB 	Master+RGBW+Strobe 

3) Select Dimming Curve: Switches from 7 to 8

Default (by bus type) 	Quadratic 	Exponential 	Linear 
-----------------------------------------------------------------------------------------------------------------	--------------------------------------------------------------------------------------------------	----------------------------------------------------------------------------------------------------	------------------------------------------------------------------------------------------------

4) Select Local Input Type: Switches from 9 to 10

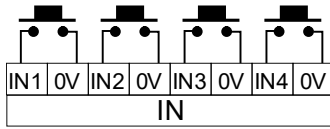
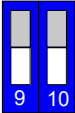
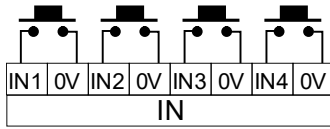
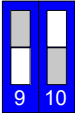
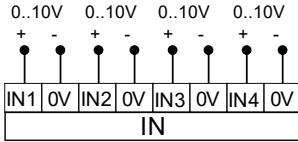
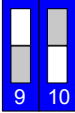
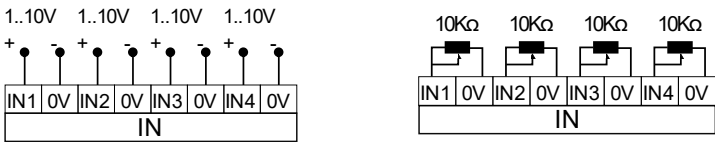
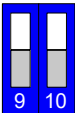
In Type	Description	Connections	Setting
Push	N.O. Pushbutton, NO memory		
	N.O. Pushbutton, MEMORY		
0-10V	Analogic 0-10V		
1-10V	Analogic 1-10V & Potentiometer		



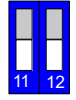
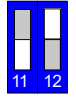
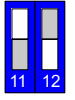
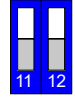

5) Set Output Frequency: Switches from 11 to 12





300Hz		600Hz		1200Hz		Reserved	
-------	-------------------------------------------------------------------------------------	-------	-------------------------------------------------------------------------------------	--------	-------------------------------------------------------------------------------------	----------	--------------------------------------------------------------------------------------

➤ **OUTPUT CURRENT REGULATION**

Function implementation only for current variant: DLD1248-4CC-DMX; DLD1248-4CC-MODBUS; DLD1248-4CC-DALI.





























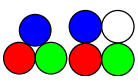







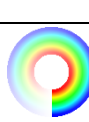
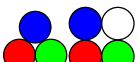

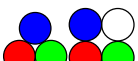

To set the Trimmer it is necessary to open the front panel of the device. See figure pag5.

	Trimmer Setting	Current Value
Position 1		250mA
Position 2		300mA
Position 3		350mA
Position 4		400mA
Position 5		450mA

	Trimmer Setting	Current Value
Position 6		500mA
Position 7		550mA
Position 8		600mA
Position 9		650mA
Position 10		700mA

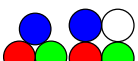

➤ **LOCAL COMMANDS FUNCTIONALITY ACCORDING TO THE SELECTED MAP**

Load Type	Map	IN 1	IN 2	IN 3	IN 4
 White Up to 4 loads	Dimmer	Dim1 	Dim2 	Dim3 	Dim4 
 White Parallel outs	Dimmer	Dimmer 			
 Tunable white Up to 2 loads	Dimmer	Dim1 	Dim2 		
 Tunable white Parallel outs	Dimmer	Dimmer 			
 Tunable white Up to 2 loads	Dim to Warm	Dim1 to Warm 	Dim2 to Warm 		
 Tunable white Parallel outs	Dim to Warm	Dimmer to Warm 			
 Tunable white Up to 2 loads	Tunable White	Dim1 	CCT1 	Dim2 	CCT2 
 Tunable white Parallel outs	Tunable White	Dimmer 	CCT 		
 RGB & RGBW	Dimmer	Dimmer 			
 RGB & RGBW	Dim to Warm	Dimmer to Warm 			
 RGB & RGBW	Tunable White	Dimmer 	CCT 		
 RGB & RGBW	Smart HSV	Dimmer 	CCT 	Colore 	Saturation 
 RGB & RGBW	RGB	Red 	Green 	Blue 	
 RGB & RGBW	RGBW	Red 	Green 	Blue 	White 
 RGB & RGBW	MRGB+	Red 	Green 	Blue 	
 RGB & RGBW	MRGBW+	Red 	Green 	Blue 	White 









EXAMPLE OF MAP SETTINGS



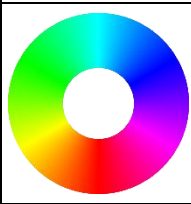
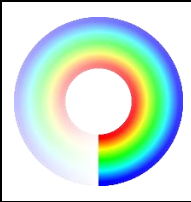

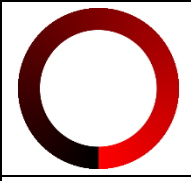
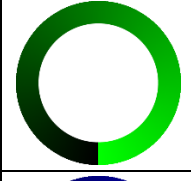
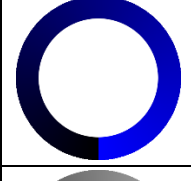

Command	Connections	Settings
White, up to 4 loads		
Group control  Command to drive all outputs in synchronous mode up to 10A total.  INPUT IN1: Simultaneous driving of the L1, L2, L3 and L4 output		
Tunable White, up to 2 loads		
RGB		
RGBW		

➤ **LOCAL INPUTS**

Available Functions: N.O. PUSH BUTTON memory / N.O. PUSH BUTTON no memory:

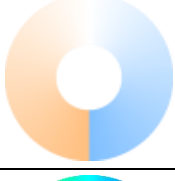
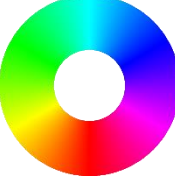
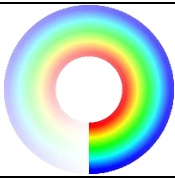
	<p><b>Dimmer</b> Dim the light following the selected dimming curve, keeping a constant color temperature. Soft Turn On with 200ms fade time, Soft Turn Off with 1s fade time.</p> <p>Click: Turn ON/OFF light. Double Click: Turn On light at 100% Long pressure (&gt;1s) from OFF: Turn on at 1% (Nighttime) Long pressure (&gt;1s) from ON: Dimmer UP/DOWN</p>										
	<p><b>Dim to Warm</b> Dim the light following the selected dimming curve. The color temperature increase with intensity. Soft Turn On with 200ms fade time, Soft Turn Off with 1s fade time.</p> <p>Click: Turn ON/OFF light. Double Click: Turn On light at 100% Long pressure (&gt;1s) from OFF: Turn on at 1% (Nighttime) Long pressure (&gt;1s) from ON: Dimmer UP/DOWN</p>										
	<p><b>CCT: Color Correction Temperature / White Balance</b> -Tunable White load: change the color temperature, keeping a constant intensity. Neutral white is 50% cold + 50% warm. -RGB load: change the equivalent color temperature. Neutral white is an equal value to R,G,B. -RGBW load: balance the white from the white output to the composite RGB output. Neutral white is 50% white + 50% R+G+B.</p> <p>Double Click: Neutral white Long pressure (&gt;1s) from OFF: Change Colour Temperature UP/DOWN (Cold ↔ Warm or White ↔ R+G+B)</p>										
	<p><b>Color rotation and selection</b> Change the colour or colour rotation speed.</p> <table border="1" data-bbox="1066 972 1490 1151"> <thead> <tr> <th>Rotation Speed</th> <th>Strobe Pulse</th> </tr> </thead> <tbody> <tr> <td>6 seconds</td> <td>10 flashes/sec.</td> </tr> <tr> <td>30 seconds</td> <td>5 flashes /sec.</td> </tr> <tr> <td>6 minutes</td> <td>2 flashes /sec.</td> </tr> <tr> <td>30 minutes</td> <td>1 flashes /sec.</td> </tr> </tbody> </table> <p>Click: Start/Stop color rotation. Double Click: Change from color (or color rotation) to white and vice-versa. Long pressure (&gt;1s) from ON: Change the rotation speed, selected from 4 predefined levels. The selected speed is visualized as a white strobe light.</p>	Rotation Speed	Strobe Pulse	6 seconds	10 flashes/sec.	30 seconds	5 flashes /sec.	6 minutes	2 flashes /sec.	30 minutes	1 flashes /sec.
Rotation Speed	Strobe Pulse										
6 seconds	10 flashes/sec.										
30 seconds	5 flashes /sec.										
6 minutes	2 flashes /sec.										
30 minutes	1 flashes /sec.										
	<p><b>Color saturation:</b> Change the color saturation: vivid color ↔ pastel color.</p> <p>Click: Toggle between white and colors. Double Click: Maximum saturation – Vivid Colors. Long pressure (&gt;1s) from white: Minimum saturation – Pastel Colors. Long pressure (&gt;1s) from colour: Change the saturation value.</p> 										
	<p><b>Red: linear change red channel.</b></p> <p>Click: Turn ON/OFF light. Double Click: Turn On light at 100% Long pressure (&gt;1s) from OFF: Turn on at 1% Long pressure (&gt;1s) from ON: Dimmer UP/DOWN</p>										
	<p><b>Green: linear change green channel.</b></p> <p>Click: Turn ON/OFF light. Double Click: Turn On light at 100% Long pressure (&gt;1s) from OFF: Turn on at 1% Long pressure (&gt;1s) from ON: Dimmer UP/DOWN</p>										
	<p><b>Blue: linear change blue channel.</b></p> <p>Click: Turn ON/OFF light. Double Click: Turn On light at 100% Long pressure (&gt;1s) from OFF: Turn on at 1% Long pressure (&gt;1s) from ON: Dimmer UP/DOWN</p>										
	<p><b>White: linear change white channel.</b></p> <p>Click: Turn ON/OFF light. Double Click: Turn On light at 100% Long pressure (&gt;1s) from OFF: Turn on at 1% Long pressure (&gt;1s) from ON: Dimmer UP/DOWN</p>										

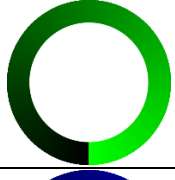
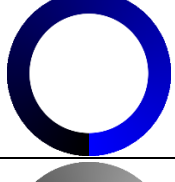
Available functions: 0-10V / 1-10V / potentiometer:

	<p><b>Dimmer</b> Dim the light following the selected dimming curve, keeping a constant color temperature. Minimum intensity =0.1%</p> <p>Below 1V = Turn OFF light. 10V = Maximum intensity</p>
	<p><b>Dim to Warm</b> Dim the light following the selected dimming curve. The color temperature increased with intensity. Minimum intensity =0.1%</p> <p>Below 1V = Turn OFF light. 10V = Maximum intensity</p>
	<p><b>CCT: Color Correction Temperature / White Balance</b> -Tunable White load: change the color temperature, keeping a constant intensity. Neutral white is 50% cold + 50% warm. -RGB load: change the equivalent color temperature. Neutral white is an equal value to R,G,B. -RGBW load: balance the white from the white output to the composite RGB output. Neutral white is 50% white + 50% R+G+B.</p> <p>Change the color temperature from warm (1V), to cold (10V).</p>
	<p><b>Color rotation and selection</b> Change the color.</p> <p>Select a color starting from red (1V), then yellow, green, cyan, blue, magenta and red again (10V).</p>
	<p><b>Color saturation:</b> Change the colour saturation: vivid colours ↔ pastel colours</p> <p>Change the saturation from white (1V) to vivid colours (10V).</p>
	<p><b>Red: linear change red channel.</b></p> <p>Below 1V = Turn OFF light. 10V = Maximum intensity</p>
	<p><b>Green: linear change green channel.</b></p> <p>Below 1V = Turn OFF light. 10V = Maximum intensity</p>
	<p><b>Blue: linear change blue channel.</b></p> <p>Below 1V = Turn OFF light. 10V = Maximum intensity</p>
	<p><b>White: linear change white channel.</b></p> <p>Below 1V = Turn OFF light. 10V = Maximum intensity</p>

## ➤ DALI BUS SETUP

In **DALI BUS SETUP** all the leds are controlled by an external DALI controller.

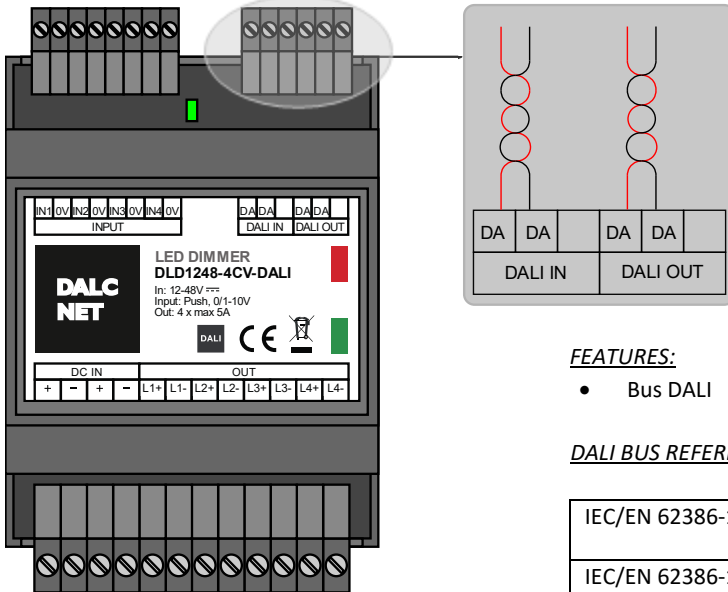

### FEATURES:

- Bus DALI

### DALI BUS REFERENCE STANDARDS

IEC/EN 62386-101	Digital addressable lighting interface - Part 101: General requirements - System
IEC/EN 62386-102	Digital addressable lighting interface - Part 102: General requirements - Control gear
IEC/EN 62386-207	Digital addressable lighting interface - Part 207: Particular requirements for control gear – LED modules (device type 6)

### ONBOARD LED:

- In the case of no bus power detected, or bus error, the led blinks fast (2 pulsed per second).
- In the case of bus power but no data, led blinks slow (1 pulse per second).
- In the case of data link active, the led stands on.

### RELATION WITH LOCAL COMMANDS:

- At power-up, in case of absence of connection to the BUS, local control is active.
- When the BUS is detected, the control passes to the BUS. It remains to the BUS until there is signal.
- In the absence of signal:
  - if the local command is N.O. PUSH BUTTON, the control passes to local command in the event of a N.O. push button pressure.
  - if the local command is 0-10V or 1-10V the control passes immediately to the local command.

### ADDRESSING

By selectors	✓
Simplified method (One ballast connected at a time)	✓
Random Address Allocation	✓

DALI	000 (Default)		Address defined by DALI
	from 001		to 064
	FFF		(reserved)

## ➤ CHANNELS MAP – DALI

 Load Type: White – up to 4 loads

Addr	Function	Map: Dimmer
+0	Dimmer 1	Dimmer (Brightness Value) 0 .. 254
+1	Dimmer 2	Dimmer (Brightness Value) 0 .. 254
+2	Dimmer 3	Dimmer (Brightness Value) 0 .. 254
+3	Dimmer 4	Dimmer (Brightness Value) 0 .. 254

 Load Type: White – Parallel outs (Macro dimmer)

Addr	Function	Map: Dimmer
+0	Dimmer	Dimmer (Brightness Value) 0 .. 254

 Load Type: Tunable White – up to 2 loads

Addr	Function	Map: Dimmer
+0	Dimmer 1	Dimmer (Brightness Value) 0 .. 254
+1	Dimmer 2	Dimmer (Brightness Value) 0 .. 254

Addr	Function	Map: Dim to Warm
+0	Dimmer 1	Dimmer (Brightness Value) 0 .. 254
+1	Dimmer 2	Dimmer (Brightness Value) 0 .. 254

Addr	Function	Map: Tunable white
+0	Dimmer 1	Dimmer (Brightness Value) 0 .. 254
+1	Color Correction 1	Color correction temperature 0 .. 254
+2	Dimmer 2	Dimmer (Brightness Value) 0 .. 254
+3	Color Correction 2	Color correction temperature 0 .. 254

 Load Type: Tunable White – Parallel outs

Addr	Function	Map: Dimmer
+0	Dimmer	Dimmer (Brightness Value) 0 .. 254

Addr	Function	Map: Dim to Warm
+0	Dimmer	Dimmer (Brightness Value) 0 .. 254

Addr	Function	Map: Tunable white
+0	Dimmer	Dimmer (Brightness Value) 0 .. 254
+1	Color Correction	Color correction temperature 0 .. 254

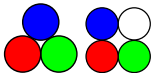

Load Type: RGB & RGBW

Addr	Function	Map: Dimmer
+0	Master Dimmer	Dimmer (Brightness Value) 0 .. 254

Addr	Function	Map: Dim to Warm
+0	Master Dimmer	Dimmer (Brightness Value) 0 .. 254

Addr	Function	Map: Tunable white
+0	Master Dimmer	Dimmer (Brightness Value) 0 .. 254
+1	Color Correction	Color correction temperature 0 .. 254

Addr	Function	Map: Smart HSV																																
+0	Master Dimmer	Dimmer (Brightness Value) 0 .. 254																																
+1	Color Correction	Color correction temperature 0 .. 254																																
+2	Hue	Hue 0 .. 254																																
+3	Hue Rotation (rainbow) Time	<table border="1" style="font-size: small;"> <tr> <th>Hue Fine</th> <th>Hold</th> <th>30min</th> <th>15min</th> <th>6min</th> <th>3min</th> <th>1min</th> <th>30s</th> <th>15s</th> <th>6s</th> <th>3s</th> </tr> <tr> <td>0 ... 15</td> <td>16 ... 25</td> <td>26 .. 51</td> <td>52 .. 76</td> <td>77 .. 102</td> <td>103..127</td> <td>128..153</td> <td>154..179</td> <td>180..204</td> <td>205..230</td> <td>231..254</td> </tr> </table>	Hue Fine	Hold	30min	15min	6min	3min	1min	30s	15s	6s	3s	0 ... 15	16 ... 25	26 .. 51	52 .. 76	77 .. 102	103..127	128..153	154..179	180..204	205..230	231..254										
Hue Fine	Hold	30min	15min	6min	3min	1min	30s	15s	6s	3s																								
0 ... 15	16 ... 25	26 .. 51	52 .. 76	77 .. 102	103..127	128..153	154..179	180..204	205..230	231..254																								
+4	Saturation	Saturation 0 .. 254																																
+5	Strobo Rate	<table border="1" style="font-size: x-small;"> <tr> <th>fix</th> <th>blackout</th> <th>1fps</th> <th>2fps</th> <th>3fps</th> <th>4fps</th> <th>5fps</th> <th>6fps</th> <th>7fps</th> <th>8fps</th> <th>9fps</th> <th>10fps</th> <th>12fps</th> <th>14fps</th> <th>16fps</th> <th>fix</th> </tr> <tr> <td>0..15</td> <td>16..31</td> <td>32..47</td> <td>48..63</td> <td>64..79</td> <td>80..95</td> <td>96..111</td> <td>112..127</td> <td>128..143</td> <td>144..159</td> <td>160..175</td> <td>176..191</td> <td>192..207</td> <td>208..223</td> <td>224..239</td> <td>240..254</td> </tr> </table>	fix	blackout	1fps	2fps	3fps	4fps	5fps	6fps	7fps	8fps	9fps	10fps	12fps	14fps	16fps	fix	0..15	16..31	32..47	48..63	64..79	80..95	96..111	112..127	128..143	144..159	160..175	176..191	192..207	208..223	224..239	240..254
fix	blackout	1fps	2fps	3fps	4fps	5fps	6fps	7fps	8fps	9fps	10fps	12fps	14fps	16fps	fix																			
0..15	16..31	32..47	48..63	64..79	80..95	96..111	112..127	128..143	144..159	160..175	176..191	192..207	208..223	224..239	240..254																			

Addr	Function	Map: RGB
+0	R	R 0 .. 254
+1	G	G 0 .. 254
+2	B	B 0 .. 254

Addr	Function	Map: RGBW
+0	R	R 0 .. 254
+1	G	G 0 .. 254
+2	B	B 0 .. 254
+3	W	W 0 .. 254

Addr	Function	Map: MRGB+																
+0	Master Dimmer	Master Dimmer (Brightness Value) 0 .. 254																
+1	R	R 0 .. 254																
+2	G	G 0 .. 254																
+3	B	B 0 .. 254																
+4	Strobo Rate	<table border="1" style="font-size: x-small;"> <tr> <th>Fix</th> <th>blackout</th> <th>1fps</th> <th>2fps</th> <th>3fps</th> <th>4fps</th> <th>5fps</th> <th>6fps</th> <th>7fps</th> <th>8fps</th> <th>9fps</th> <th>10fps</th> <th>12fps</th> <th>14fps</th> <th>16fps</th> <th>fix</th> </tr> </table>	Fix	blackout	1fps	2fps	3fps	4fps	5fps	6fps	7fps	8fps	9fps	10fps	12fps	14fps	16fps	fix
Fix	blackout	1fps	2fps	3fps	4fps	5fps	6fps	7fps	8fps	9fps	10fps	12fps	14fps	16fps	fix			

Addr	Function	Map: MRGBW+																
+0	Master Dimmer	Master Dimmer (Brightness Value) 0 .. 254																
+1	R	R 0 .. 254																
+2	G	G 0 .. 254																
+3	B	B 0 .. 254																
+4	W	W 0 .. 254																
+5	Strobo Rate	<table border="1" style="font-size: x-small;"> <tr> <th>Fix</th> <th>blackout</th> <th>1fps</th> <th>2fps</th> <th>3fps</th> <th>4fps</th> <th>5fps</th> <th>6fps</th> <th>7fps</th> <th>8fps</th> <th>9fps</th> <th>10fps</th> <th>12fps</th> <th>14fps</th> <th>16fps</th> <th>fix</th> </tr> </table>	Fix	blackout	1fps	2fps	3fps	4fps	5fps	6fps	7fps	8fps	9fps	10fps	12fps	14fps	16fps	fix
Fix	blackout	1fps	2fps	3fps	4fps	5fps	6fps	7fps	8fps	9fps	10fps	12fps	14fps	16fps	fix			







## ➤ DMX+RDM BUS SETUP

With the **DMX+RDM BUS** in the “slave” condition the outputs are managed by an external DMX controller.  
In the “master” condition, the DMX+RDM allows the communications between devices.

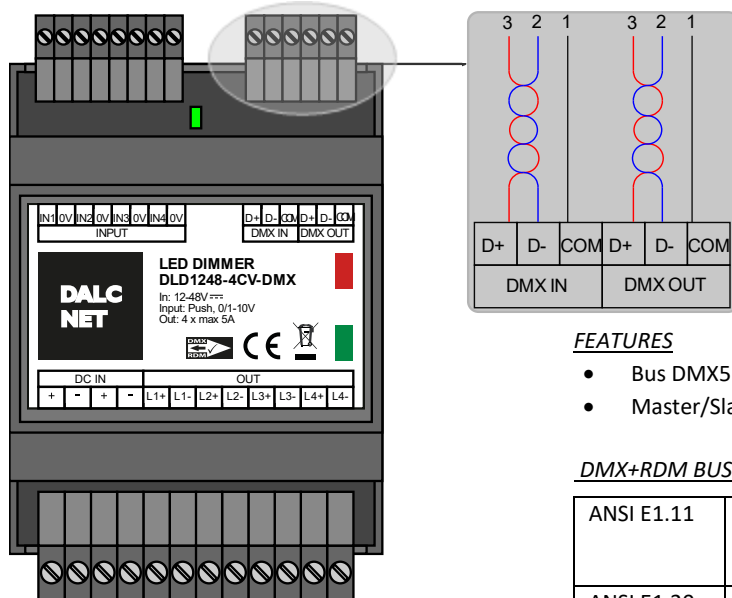

Use	3-Pin XLR Pin #	DMX512 Function
Common Reference	1	Data Link Common
Primary Data Link	2	Data 1-
	3	Data 1+
Secondary Data Link (Optional – see clause 4.8)	4	Data 2-
	5	Data 2+

### FEATURES

- Bus DMX512-A (NSC+RDM)
- Master/Slave

### DMX+RDM BUS REFERENCE STANDARDS

ANSI E1.11	Entertainment Technology - USITT DMX512-A - Asynchronous Serial Digital Data Transmission Standard for Controlling Lighting Equipment and Accessories
ANSI E1.20	Entertainment Technology-RDM-Remote Device Management over USITT DMX512 Networks

### TECHNICAL SPECIFICATIONS

Standard DMX512-A/RDM
-----------------------

### ONBOARD LED:

- In the case of bus error, the led blinks fast (2 pulsed per second).
- In the case of no bus detected, led blinks slow (1 pulse per second).
- In the case of data link active, the led stands on.

### RELATION WITH LOCAL COMMANDS:

- At power-up, in case of absence of connecting to the BUS, local control is active.
- When the BUS is detected, the control passes to the BUS. It remains to the BUS until there is signal.
- In the absence of signal:
  - if the local command is N.O. PUSH BUTTON, the control passes to local command in the event of a N.O. push button pressure.
  - if the local command is 0-10V or 1-10V the control passes immediately to the local command.

### ADDRESSING

RDM	✓
By selectors	✓

DMX	000 (Default)		Addressing set by RDM protocol
	from 001		to 512 DMX addressing from 1 to 512
	F00		MASTER

➤ **CHANNELS MAP – DMX512**

○ Load Type: White – up to 4 loads

Ch.	Function	Map: Dimmer
1	Dimmer 1	Dimmer (Brightness Value) 0 .. 255
2	Dimmer 2	Dimmer (Brightness Value) 0 .. 255
3	Dimmer 3	Dimmer (Brightness Value) 0 .. 255
4	Dimmer 4	Dimmer (Brightness Value) 0 .. 255

○ Load Type: White – Parallel outs (Macro dimmer)

Ch.	Function	Map: Dimmer
1	Dimmer	Dimmer (Brightness Value) 0 .. 255

●● Load Type: Tunable White – up to 2 loads

Ch.	Function	Map: Dimmer
1	Dimmer 1	Dimmer (Brightness Value) 0 .. 255
2	Dimmer 2	Dimmer (Brightness Value) 0 .. 255

Ch.	Function	Map: Dim to Warm
1	Dimmer 1	Dimmer (Brightness Value) 0 .. 255
2	Dimmer 2	Dimmer (Brightness Value) 0 .. 255

Ch.	Function	Map: Tunable white
1	Dimmer 1	Dimmer (Brightness Value) 0 .. 255
2	Color Correction 1	Color correction temperature 0 .. 255
3	Dimmer 2	Dimmer (Brightness Value) 0 .. 255
4	Color Correction 2	Color correction temperature 0 .. 255

●● Load Type: Tunable White – Parallel outs

Ch.	Function	Map: Dimmer
1	Dimmer	Dimmer (Brightness Value) 0 .. 255

Ch.	Function	Map: Dim to Warm
1	Dimmer	Dimmer (Brightness Value) 0 .. 255

Ch.	Function	Map: Tunable white
1	Dimmer	Dimmer (Brightness Value) 0 .. 255
2	Color Correction	Color correction temperature 0 .. 255

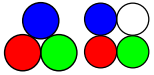

Load Type: RGB & RGBW

Ch.	Function	Map: Dimmer
1	Master Dimmer	Dimmer (Brightness Value) 0 .. 255

Ch.	Function	Map: Dim to Warm
1	Master Dimmer	Dimmer (Brightness Value) 0 .. 255

Ch.	Function	Map: Tunable white
1	Master Dimmer	Dimmer (Brightness Value) 0 .. 255
2	Color Correction	Color correction temperature 0 .. 255

Ch.	Function	Smart HSV																																
1	Master Dimmer	Dimmer (Brightness Value) 0 .. 255																																
2	Color Correction	Color correction temperature 0 .. 255																																
3	Hue	Hue 0 .. 255																																
4	Hue Rotation (rainbow) Time	<table border="1" style="font-size: small;"> <tr> <td>Hue Fine</td> <td>Hold</td> <td>30min</td> <td>15min</td> <td>6min</td> <td>3min</td> <td>1min</td> <td>30s</td> <td>15s</td> <td>6s</td> <td>3s</td> </tr> <tr> <td>0 ... 15</td> <td>16 ... 25</td> <td>26 .. 51</td> <td>52 .. 76</td> <td>77 .. 102</td> <td>103..127</td> <td>128..153</td> <td>154..179</td> <td>180..204</td> <td>205..230</td> <td>231..254</td> </tr> </table>	Hue Fine	Hold	30min	15min	6min	3min	1min	30s	15s	6s	3s	0 ... 15	16 ... 25	26 .. 51	52 .. 76	77 .. 102	103..127	128..153	154..179	180..204	205..230	231..254										
Hue Fine	Hold	30min	15min	6min	3min	1min	30s	15s	6s	3s																								
0 ... 15	16 ... 25	26 .. 51	52 .. 76	77 .. 102	103..127	128..153	154..179	180..204	205..230	231..254																								
5	Saturation	Saturation 0 .. 255																																
6	Strobo Rate	<table border="1" style="font-size: x-small;"> <tr> <td>fix</td><td>blackout</td><td>1fps</td><td>2fps</td><td>3fps</td><td>4fps</td><td>5fps</td><td>6fps</td><td>7fps</td><td>8fps</td><td>9fps</td><td>10fps</td><td>12fps</td><td>14fps</td><td>16fps</td><td>fix</td> </tr> <tr> <td>0..15</td><td>16..31</td><td>32..47</td><td>48..63</td><td>64..79</td><td>80..95</td><td>96..111</td><td>112..127</td><td>128..143</td><td>144..159</td><td>160..175</td><td>176..191</td><td>192..207</td><td>208..223</td><td>224..239</td><td>240..254</td> </tr> </table>	fix	blackout	1fps	2fps	3fps	4fps	5fps	6fps	7fps	8fps	9fps	10fps	12fps	14fps	16fps	fix	0..15	16..31	32..47	48..63	64..79	80..95	96..111	112..127	128..143	144..159	160..175	176..191	192..207	208..223	224..239	240..254
fix	blackout	1fps	2fps	3fps	4fps	5fps	6fps	7fps	8fps	9fps	10fps	12fps	14fps	16fps	fix																			
0..15	16..31	32..47	48..63	64..79	80..95	96..111	112..127	128..143	144..159	160..175	176..191	192..207	208..223	224..239	240..254																			

Ch.	Function	Map: RGB
1	R	R 0 .. 255
2	G	G 0 .. 255
3	B	B 0 .. 255

Ch.	Function	Map: RGBW
1	R	R 0 .. 255
2	G	G 0 .. 255
3	B	B 0 .. 255
4	W	W 0 .. 255

Ch.	Function	Map: MRGB+																
1	Master Dimmer	Master Dimmer (Brightness Value) 0 .. 255																
2	R	R 0 .. 255																
3	G	G 0 .. 255																
4	B	B 0 .. 255																
5	Strobo Rate	<table border="1" style="font-size: x-small;"> <tr> <td>Fix</td><td>blackout</td><td>1fps</td><td>2fps</td><td>3fps</td><td>4fps</td><td>5fps</td><td>6fps</td><td>7fps</td><td>8fps</td><td>9fps</td><td>10fps</td><td>12fps</td><td>14fps</td><td>16fps</td><td>fix</td> </tr> </table>	Fix	blackout	1fps	2fps	3fps	4fps	5fps	6fps	7fps	8fps	9fps	10fps	12fps	14fps	16fps	fix
Fix	blackout	1fps	2fps	3fps	4fps	5fps	6fps	7fps	8fps	9fps	10fps	12fps	14fps	16fps	fix			

Ch.	Function	Map: MRGBW+																
1	Master Dimmer	Master Dimmer (Brightness Value) 0 .. 255																
2	R	R 0 .. 255																
3	G	G 0 .. 255																
4	B	B 0 .. 255																
5	W	W 0 .. 255																
6	Strobo Rate	<table border="1" style="font-size: x-small;"> <tr> <td>Fix</td><td>blackout</td><td>1fps</td><td>2fps</td><td>3fps</td><td>4fps</td><td>5fps</td><td>6fps</td><td>7fps</td><td>8fps</td><td>9fps</td><td>10fps</td><td>12fps</td><td>14fps</td><td>16fps</td><td>fix</td> </tr> </table>	Fix	blackout	1fps	2fps	3fps	4fps	5fps	6fps	7fps	8fps	9fps	10fps	12fps	14fps	16fps	fix
Fix	blackout	1fps	2fps	3fps	4fps	5fps	6fps	7fps	8fps	9fps	10fps	12fps	14fps	16fps	fix			

➤ **RDM COMMANDS**

<i>REQUIRED PARAMETERS</i>	
DISC_UNIQUE_BRANCH	✓
DISC_UN_MUTE	✓
SUPPORTED_PARAMETERS	✓
PARAMETERS_DESCRIPTION	✓
DEVICE_INFO	✓
SOFTWARE_VERSION_LABEL	✓
DMX_START_ADDRESS	✓
IDENTIFY_DEVICE	✓

<i>SUPPORTED PARAMETERS</i>	
PRODUCT_DETAIL_ID_LIST	✓
DEVICE_MODEL_DESCRIPTION	✓
MANUFACTURER_LABEL	✓
DEVIDE_LABEL	✓
BOOT_SOFTWARE_VERSION_ID	✓
BOOT_SOFTWARE_VERSION_LABEL	✓
DMX_PERSONALITY	✓
DMX_PERSONALITY_DESCRIPTION	✓
SLOT_INFO	✓
SLOT_DESCRIPTION	✓
DEFAULT_SLOT_VALUE	✓

➤ **DMX MASTER / SLAVE**

Example to Master / Slave connection

More DLD1248-4CH-DMX device can be connected following a master/slave configuration. Master and Slave must be the same DIP-SWITCH configuration. To select the desired local command, DIP-SWITCH need to be set as explained in **Setup DMX MASTER/SLAVE** on page 21 and 22.

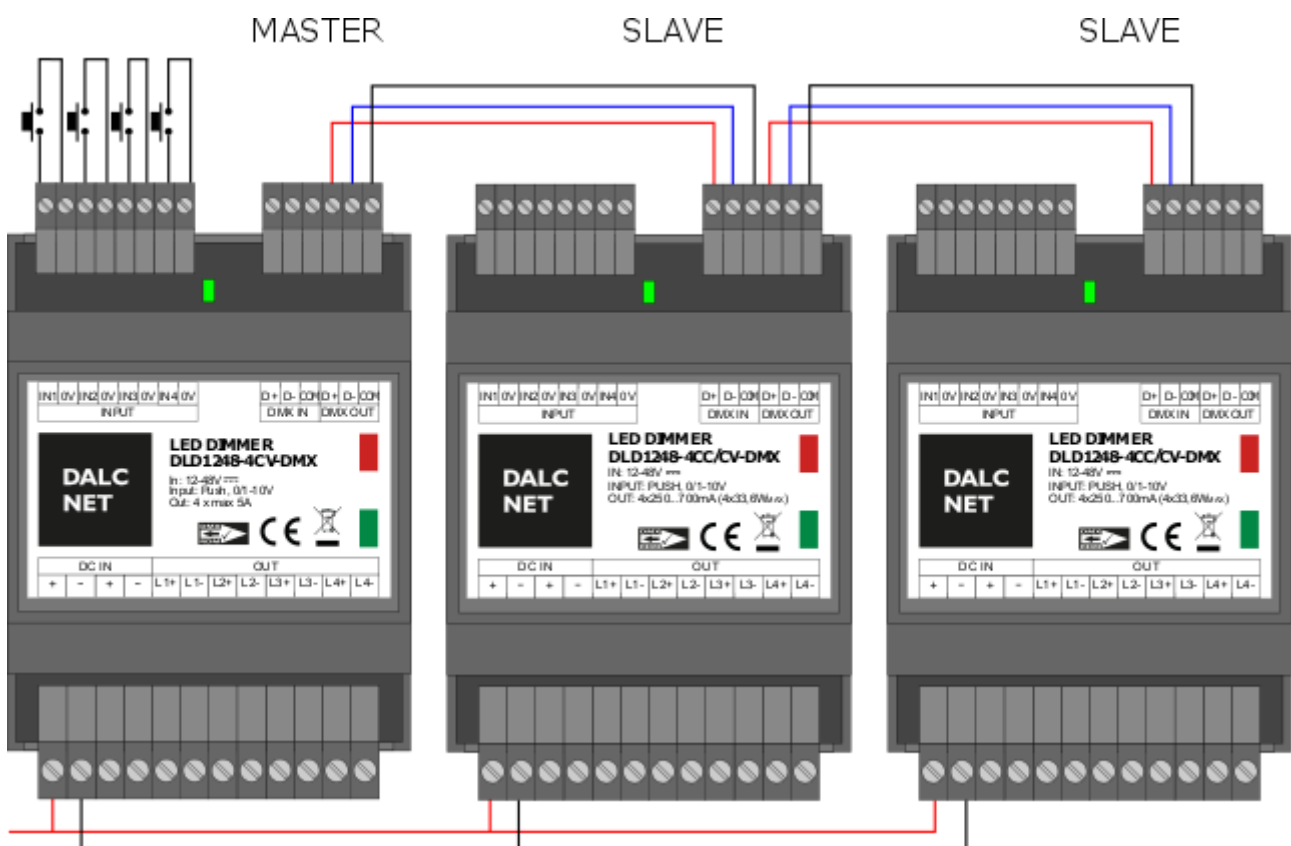



➤ **SETUP DMX Master/Slave**

**MASTER:**

Note: Master and Slave must have set the same map, (switches from 4 to 6).

Default Master:

F00		MASTER
-----	--	--------

Master with FADE UP / FADE DOWN:

from F00		to FFF		<p>MASTER with Fade: Selector "x10" = UP fade time Selector "x1" = DOWN fade time</p> <p>0 = no Fade, F=60 seconds (see table)</p>
-------------	--	-----------	--	--------------------------------------------------------------------------------------------------------------------------------------------

Fades times:

0	1	2	3	4	5	6	7	8	9	A	B	C	D	E	F
NO fade	0.5s	1s	2s	3s	4s	5s	6s	7s	8s	9s	10s	15s	20s	30s	60s

Examples:

Turn on/off without fade (no Fade UP/DOWN): F00

Turn on without fade (no fade UP) and turn off fade of 5 seconds (fade DOWN): F06

Turn on fade of 1 seconds (fade UP) and turn off fade of 10 seconds (fade DOWN): F2B

Notes:

This function is available on maps: "Dimmer", "Dim to Warm", "Tunable White", "Smart Colors"

**The Slaves follow master fade ramps.**



**SLAVE:**

Note: Master and Slave must have set the same map (switches from 4 to 6).

Default Slave:

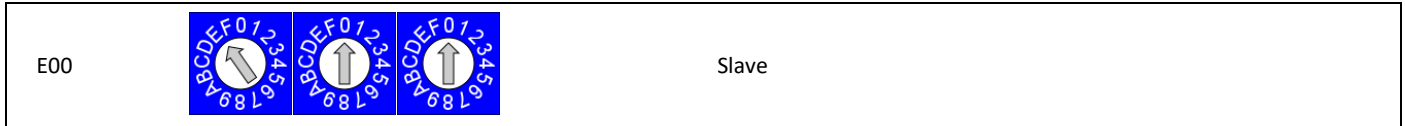

Slave: **Color Wave effect** (only in map "Smart HSV"):



Easy creates a "color wave" effect, adding a delay from the master phase synchronism. The delay is selected on each slave in step of 15°, from 0° (E00) to 345° (E23)

Slave, Color Wave effect:  
 00 = sync with master (no wave)  
 01 = 15° phase  
 ...  
 08 = 120° phase  
 ...  
 16 = 240° phase  
 ...  
 23 = 345° phase

Phase delays:

E00	E01	E02	E03	E04	E05	E06	E07	E08	E09	E10	E11
0°	15°	30°	45°	60°	75°	90°	105°	120°	135°	150°	165°
E12	E13	E14	E15	E16	E17	E18	E19	E20	E21	E22	E23
180°	195°	210°	225°	240°	255°	270°	285°	300°	315°	330°	345°

Examples:

E00 0° Sync with master	E04 60° phase delay	E08 120° phase delay R→B, G→R, B→G	E12 180° phase delay Complementary color	E16 240° phase delay R→G, G→B, B→R	E20 300° phase delay



## ➤ MODBUS SETUP

In **MODBUS SETUP** in the “slave” condition the outputs LEDs are managed by an external MODBUS RTU master controller (RS-485)

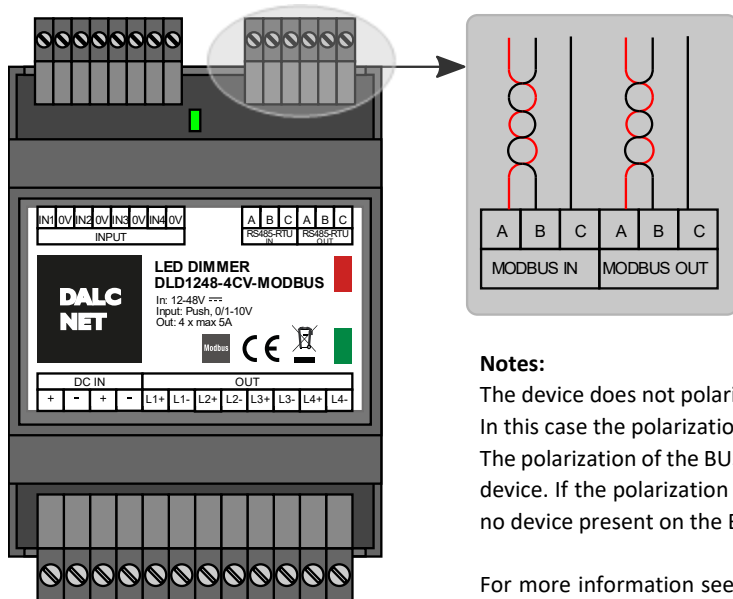

### FEATURES

- BUS MODBUS RTU SLAVE on RS485

### MODBUS REFERENCE STANDARDS

- MODBUS APPLICATION PROTOCOL SPECIFICATION V1.1b

### Notes:

The device does not polarize and there isn't implemented the ability to polarize the BUS. In this case the polarization of the BUS must be implemented externally.

The polarization of the BUS can be carried out by the Master Modbus or on the terminals of the device. If the polarization of the BUS is carried out by Master or on the terminal of the device, no device present on the BUS must implement any polarization.

For more information see the MODBUS specification **“MODBUS over serial line specification and implementation guide V1.02”**.

### ONBOARD LED:

- In the case of bus error, the led blinks fast (2 pulsed per second).
- In the case of no bus detected, led blinks slow (1 pulse per second).
- In the case of data link active, the led stands on.

### RELATION WITH LOCAL COMMANDS

- **LOCAL COMMAND SET UP AS N.O. PUSH BUTTON:**  
The local command is always active even in presence of the bus. If you use the local command, the available variables are updated in read/write to the bus. Instead if you use the bus, the status of local command is update.  
This setting allows you to control the output status whether local command or bus at the same time. The local command has always priority to bus command. The status of the device is visible from bus and can be viewed by a supervision system.
- **LOCAL COMMAND SET UP AS 0..10V, 1..10V OR POTENTIOMETER**  
At power-up, in case of absence of connection to the BUS, local control is active.  
When the BUS is detected, the control passes to the BUS. It remains to the BUS until there is signal.  
In absence of signal, the control passes immediately to the local command.

### ADDRESSING BY SELECTORS

Selectors x10, x1 (middle and right)					
Modbus	00 (Default)				Default modbus ID (1)
	from 01			to 99	Modbus ID

Selector x100 (left)								
Modbus								
	0	1	2	3	4	5	6	7
	115200 baud	115200 baud	38400 baud	38400 baud	19200 baud	19200 baud	9600 baud	9600 baud
	8N1	8E1	8N1	8E1	8N1	8E1	8N1	8E1



## ➤ CHANNELS MAP – MODBUS

○ Load Type: White – up to 4 loads

Var	Function	Map: Dimmer
0	Dimmer 1	Dimmer (Brightness Value) 0 .. 255
1	Dimmer 2	Dimmer (Brightness Value) 0 .. 255
2	Dimmer 3	Dimmer (Brightness Value) 0 .. 255
3	Dimmer 4	Dimmer (Brightness Value) 0 .. 255

○ Load Type: White – Parallel outs (Macro dimmer)

Var	Function	Map: Dimmer
0	Dimmer	Dimmer (Brightness Value) 0 .. 255

●● Load Type: Tunable White – up to 2 loads

Var	Function	Map: Dimmer
0	Dimmer 1	Dimmer (Brightness Value) 0 .. 255
1	Dimmer 2	Dimmer (Brightness Value) 0 .. 255

Var	Function	Map: Dim to Warm
0	Dimmer 1	Dimmer (Brightness Value) 0 .. 255
1	Dimmer 2	Dimmer (Brightness Value) 0 .. 255

Var	Function	Map: Tunable white
0	Dimmer 1	Dimmer (Brightness Value) 0 .. 255
1	Color Correction 1	Color correction temperature 0 .. 255
2	Dimmer 2	Dimmer (Brightness Value) 0 .. 255
3	Color Correction 2	Color correction temperature 0 .. 255

●● Load Type: Tunable White – Parallel outs

Var	Function	Map: Dimmer
0	Dimmer	Dimmer (Brightness Value) 0 .. 255

Var	Function	Map: Dim to Warm
0	Dimmer	Dimmer (Brightness Value) 0 .. 255

Var	Function	Map: Tunable white
0	Dimmer	Dimmer (Brightness Value) 0 .. 255
1	Color Correction	Color correction temperature 0 .. 255

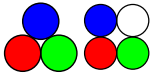

Load Type: RGB & RGBW

Var	Function	Map: Dimmer
0	Master Dimmer	Dimmer (Brightness Value) 0 .. 255

Var	Function	Map: Dim to Warm
0	Master Dimmer	Dimmer (Brightness Value) 0 .. 255

Var	Function	Map: Tunable white
0	Master Dimmer	Dimmer (Brightness Value) 0 .. 255
1	Color Correction	Color temperature correction 0 .. 255

Var	Function	Smart HSV																																
0	Master Dimmer	Dimmer (Brightness Value) 0 .. 255																																
1	Color Correction	Color temperature correction 0 .. 255																																
2	Hue	Hue 0 .. 255																																
3	Hue Rotation (rainbow) Time	<table border="1" style="font-size: small;"> <tr> <th>Hue Fine</th> <th>Hold</th> <th>30min</th> <th>15min</th> <th>6min</th> <th>3min</th> <th>1min</th> <th>30s</th> <th>15s</th> <th>6s</th> <th>3s</th> </tr> <tr> <td>0 ... 15</td> <td>16 ... 25</td> <td>26 .. 51</td> <td>52 .. 76</td> <td>77 .. 102</td> <td>103..127</td> <td>128..153</td> <td>154..179</td> <td>180..204</td> <td>205..230</td> <td>231..254</td> </tr> </table>	Hue Fine	Hold	30min	15min	6min	3min	1min	30s	15s	6s	3s	0 ... 15	16 ... 25	26 .. 51	52 .. 76	77 .. 102	103..127	128..153	154..179	180..204	205..230	231..254										
Hue Fine	Hold	30min	15min	6min	3min	1min	30s	15s	6s	3s																								
0 ... 15	16 ... 25	26 .. 51	52 .. 76	77 .. 102	103..127	128..153	154..179	180..204	205..230	231..254																								
4	Saturation	Saturation 0 .. 255																																
5	Strobo Rate	<table border="1" style="font-size: x-small;"> <tr> <th>fix</th> <th>blackout</th> <th>1fps</th> <th>2fps</th> <th>3fps</th> <th>4fps</th> <th>5fps</th> <th>6fps</th> <th>7fps</th> <th>8fps</th> <th>9fps</th> <th>10fps</th> <th>12fps</th> <th>14fps</th> <th>16fps</th> <th>fix</th> </tr> <tr> <td>0..15</td> <td>16..31</td> <td>32..47</td> <td>48..63</td> <td>64..79</td> <td>80..95</td> <td>96..111</td> <td>112..127</td> <td>128..143</td> <td>144..159</td> <td>160..175</td> <td>176..191</td> <td>192..207</td> <td>208..223</td> <td>224..239</td> <td>240..254</td> </tr> </table>	fix	blackout	1fps	2fps	3fps	4fps	5fps	6fps	7fps	8fps	9fps	10fps	12fps	14fps	16fps	fix	0..15	16..31	32..47	48..63	64..79	80..95	96..111	112..127	128..143	144..159	160..175	176..191	192..207	208..223	224..239	240..254
fix	blackout	1fps	2fps	3fps	4fps	5fps	6fps	7fps	8fps	9fps	10fps	12fps	14fps	16fps	fix																			
0..15	16..31	32..47	48..63	64..79	80..95	96..111	112..127	128..143	144..159	160..175	176..191	192..207	208..223	224..239	240..254																			

Var	Function	Map: RGB
0	R	R 0 .. 255
1	G	G 0 .. 255
2	B	B 0 .. 255

Var	Function	Map: RGBW
0	R	R 0 .. 255
1	G	G 0 .. 255
2	B	B 0 .. 255
3	W	W 0 .. 255

Var	Function	Map: MRGB+																
0	Master Dimmer	Master Dimmer (Brightness Value) 0 .. 255																
1	R	R 0 .. 255																
2	G	G 0 .. 255																
3	B	B 0 .. 255																
4	Strobo Rate	<table border="1" style="font-size: x-small;"> <tr> <th>Fix</th> <th>blackout</th> <th>1fps</th> <th>2fps</th> <th>3fps</th> <th>4fps</th> <th>5fps</th> <th>6fps</th> <th>7fps</th> <th>8fps</th> <th>9fps</th> <th>10fps</th> <th>12fps</th> <th>14fps</th> <th>16fps</th> <th>fix</th> </tr> </table>	Fix	blackout	1fps	2fps	3fps	4fps	5fps	6fps	7fps	8fps	9fps	10fps	12fps	14fps	16fps	fix
Fix	blackout	1fps	2fps	3fps	4fps	5fps	6fps	7fps	8fps	9fps	10fps	12fps	14fps	16fps	fix			

Var	Function	Map: MRGBW+																
0	Master Dimmer	Master Dimmer (Brightness Value) 0 .. 255																
1	R	R 0 .. 255																
2	G	G 0 .. 255																
3	B	B 0 .. 255																
4	W	W 0 .. 255																
5	Strobo Rate	<table border="1" style="font-size: x-small;"> <tr> <th>Fix</th> <th>blackout</th> <th>1fps</th> <th>2fps</th> <th>3fps</th> <th>4fps</th> <th>5fps</th> <th>6fps</th> <th>7fps</th> <th>8fps</th> <th>9fps</th> <th>10fps</th> <th>12fps</th> <th>14fps</th> <th>16fps</th> <th>fix</th> </tr> </table>	Fix	blackout	1fps	2fps	3fps	4fps	5fps	6fps	7fps	8fps	9fps	10fps	12fps	14fps	16fps	fix
Fix	blackout	1fps	2fps	3fps	4fps	5fps	6fps	7fps	8fps	9fps	10fps	12fps	14fps	16fps	fix			

➤ **SUPPORTED FUNCTIONS FOR READING AND WRITING – MODBUS RTU**

Function code		
0x01	Read Coils	✘
0x02	Read Discrete Inputs	✘
0x03	Read Holding Registers	✔
0x04	Read Input Register	✘
0x05	Write Single Coil	✘
0x06	Write Single Register	✔
0x07	Read Exception Status	✘
0x08	Diagnostic	✘
0x0B	Get Co Event Counter	✘
0x0C	Get Com Event Log	✘
0x0F	Write Multiple Coils	✘
0x10	Write Multiple Registers	✔
0x11	Report Server ID	✘
0x14	Read File Record	✘
0x15	Write File Record	✘
0x16	Mask Write Register	✘
0x17	Read/Write Multiple Registers	✘
0x18	Read FIFO queue	✘
0x2B	Read Device Identification	✘