

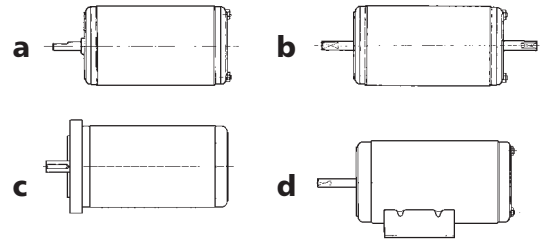

motor

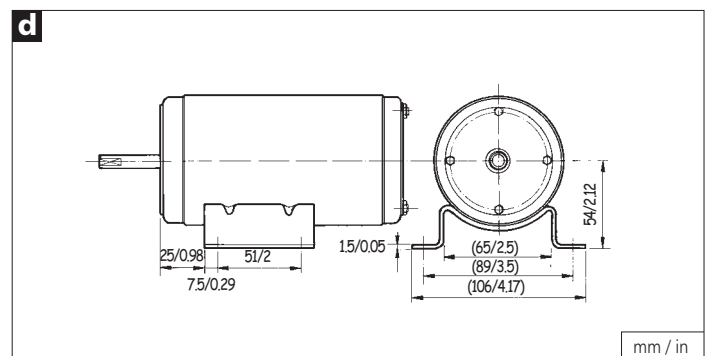

Reference number Referencia	Nominal voltage Tensión nominal	Nominal torque Par nominal	Nominal speed Velocidad nominal	Nominal current Corriente nominal	Starting torque Par de arranque	Starting current Corriente de Arranque	Shaft Eje	Connections Conexiones	Wiring diag. Esq. elect.	Approximate weight Peso aproximado	Watertightness Grado de estanqueidad	Design: a, b, c, d Diseño: a, b, c, d	Curve Curva
	Un (V)	Mn (N.m./Lbf.in)	nn (r.p.m.)	In (A)	Ma (N.m./Lbf.in)	Ia (A)				P (kg / Lb.t)	IP		
168.4105.20.04	12	0.50 / 4.42	1900	14	3.0 / 26.5	64	E8	C8	EE1	2.6 / 6.9	IP40	a	37
168.4105.30.04	24	0.50 / 4.42	1900	7	3.0 / 26.5	32	E8	C8	EE1	2.6 / 6.9	IP40	a	37
168.4108.20.04	12	0.45 / 3.98	2800	19	3.0 / 26.5	100	E9	C9	EE4	2.6 / 6.9	IP40	a	39
168.4108.30.04	24	0.45 / 3.98	2800	10	3.0 / 26.5	52	E9	C9	EE4	2.6 / 6.9	IP40	a	39
168.4111.20.04	12	0.75 / 6.64	1000	11	2.8 / 24.8	36	E11	C9	EE2	2.6 / 6.9	IP40	a	40
168.4111.30.04	24	0.75 / 6.64	1000	5.5	2.8 / 24.8	18	E11	C9	EE2	2.6 / 6.9	IP40	a	40
168.4112.20.04	12	0.70 / 6.19	1500	14	3.0 / 26.5	56	E12	C11	EE2	2.6 / 6.9	IP40	a	42
168.4112.30.04	24	0.70 / 6.19	1500	7	3.0 / 26.5	28	E12	C11	EE2	2.6 / 6.9	IP40	a	42
168.4115.30.04	24	0.50 / 4.42	3000	11	3.0 / 26.5	70	E13/E41	C13	EE2	2.6 / 6.9	IP40	a	41
168.4116.20.04	12	0.50 / 4.42	1900	14	3.0 / 26.5	64	E8	C8	EE1	2.6 / 6.9	IP40	d	37
168.4116.30.04	24	0.50 / 4.42	1900	7	3.0 / 26.5	32	E8	C8	EE1	2.6 / 6.9	IP40	d	37
168.4121.30.04E	24	0.50 / 4.42	3000	11	3.0 / 26.5	70	E11/E11	C13	F2	2.6 / 6.9	IP40	b	41
168.4122.30.04	24	0.75 / 6.64	1000	5.5	2.8 / 24.8	18	E13/E41	C13	EE2	2.6 / 6.9	IP40	a	40
168.4123.20.04	12	0.50 / 4.42	2100	16	3.0 / 26.5	76	E13/E41	C13	EE2	2.6 / 6.9	IP40	a	43
168.4123.30.04	24	0.50 / 4.42	2100	8	3.0 / 26.5	38	E13/E41	C13	EE2	2.6 / 6.9	IP40	a	43
168.4134.30.04	24	0.30 / 2.65	750	1.5	1.5 / 13.3	7	E59	C9	EE2	2.6 / 6.9	IP40	a	44
168.4136.3B.00E	24	0.75 / 6.64	1000	5.5	2.8 / 24.8	18	E63	C42	F2	2.6 / 6.9	IP40	c	40

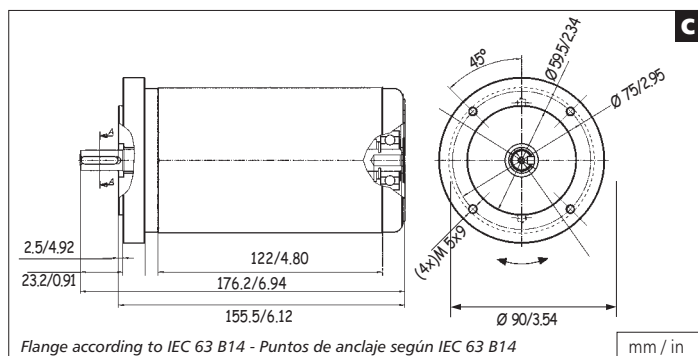
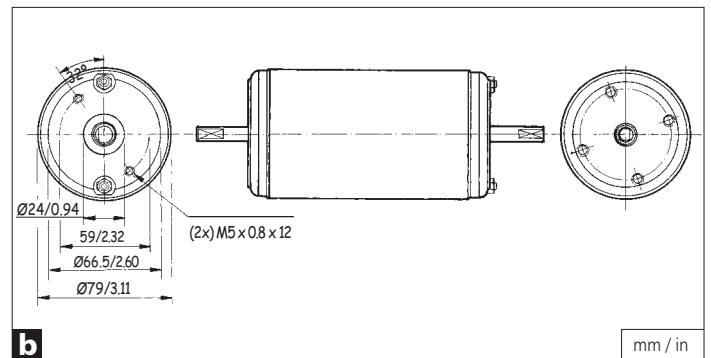
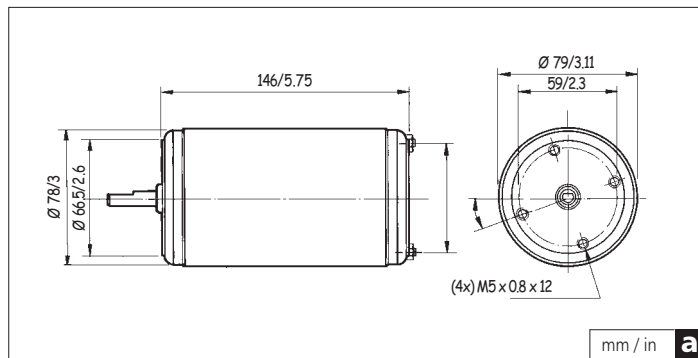

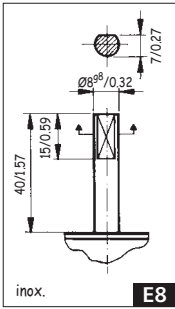

E8

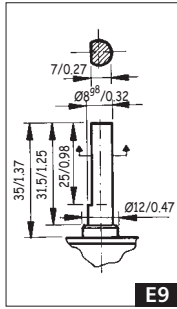

E9

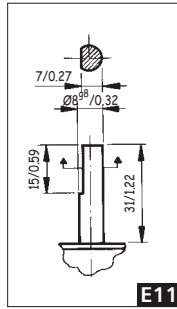

E11

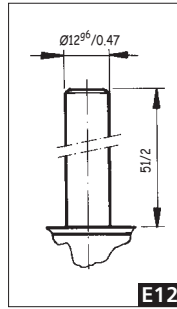

E12

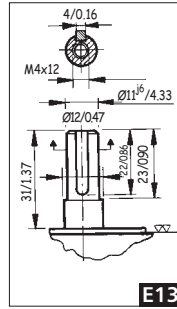

E13

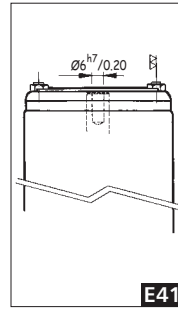

E41

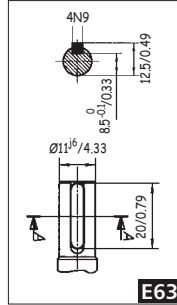

E63

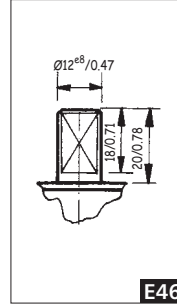

E46

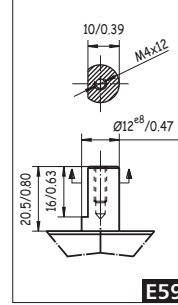

E59

111

119

210

CONNECTION - CONEXIÓN

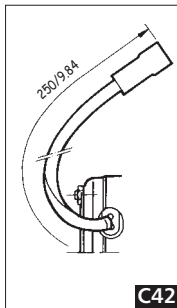

C42

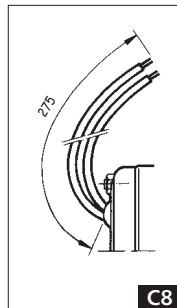

C8

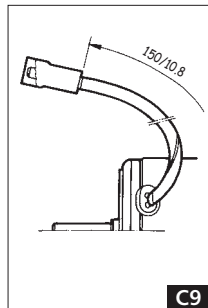

C9

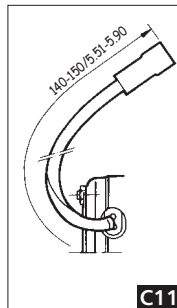

C11

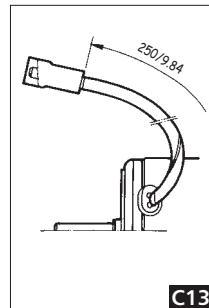

C13

258

259

316

WIRING DIAGRAM - ESQUEMA ELÉCTRICO

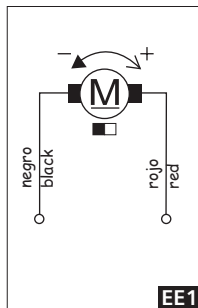

EE1

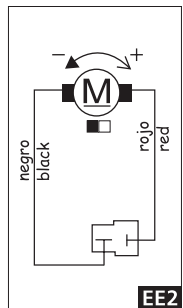

EE2

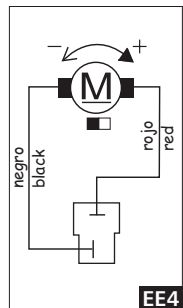

EE4

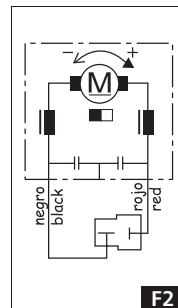

F2

319

162

CURVES - CURVAS

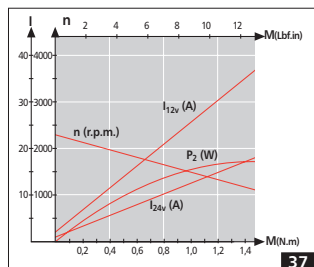

37

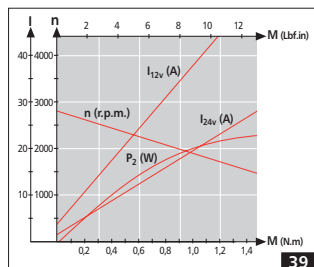

39

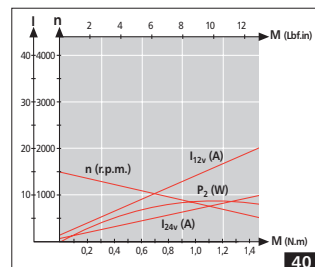

40

168

169

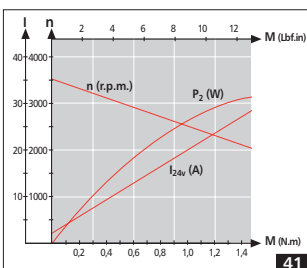

41

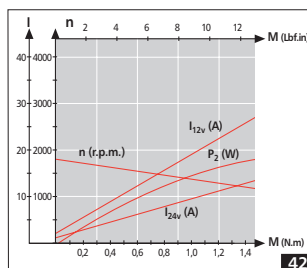

42

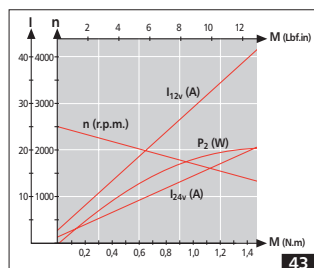

43

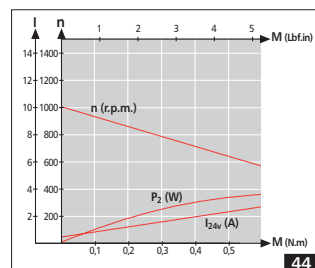

44

260

269