

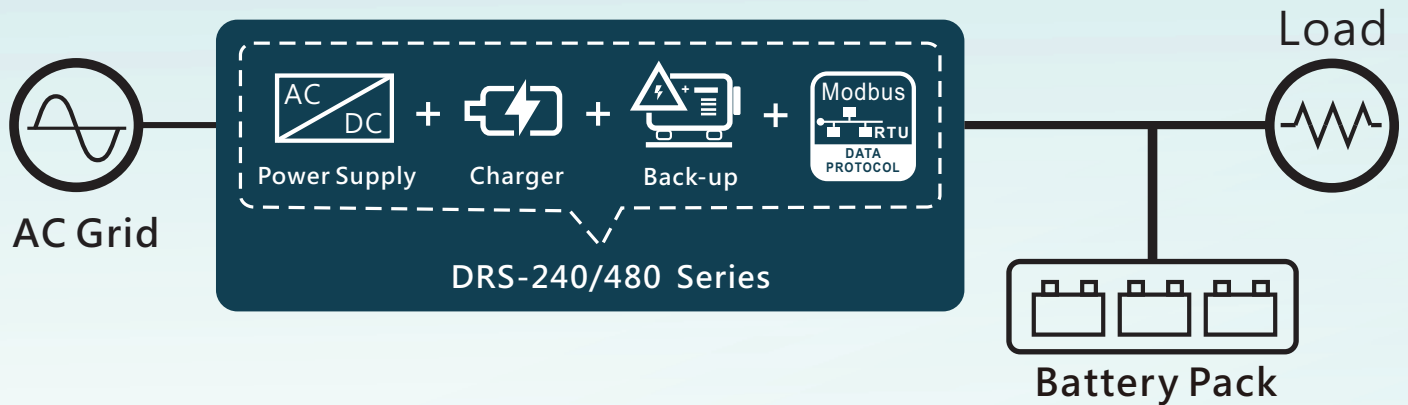

DRS Series User Manual



All-in-one Multi-function Security Power Supply



The DRS series is a DIN-rail type, digital security power supply launched by MEAN WELL. It integrates DC output, battery charge, uninterruptible power source (DC-UPS) and Modbus digital communication in tiny dimensions, thanks to microelectronics. The DRS series accepts the universal input between 90VAC and 305VAC. In addition to the key protection features, such as overload protection, over voltage protection, battery low voltage, disconnect and battery reverse polarity protection. The DRS series also provides Form-C contacts and LED indicators as alarm signals for AC-fail, battery low, charger circuit fail and DC-OK, allowing easy integration into security systems. This series has 2-stage and 3-stage charge curves selectable by DIP switch, charging curves can also be programmed by SBP-001 as well as manual adjustment through a potentiometer (ADJ) on the panel to change charge current from 20% to 100%. The DRS series is suitable for Lead-acid and Lithium batteries with various capacities and can be remotely monitored by communication. The DRS series is a great solution for smart cities and building securities.

Content:

1. Safety Guidelines	1	5.7 Battery Start by Force Button	54
2. Introduction	2	5.8 Battery temperature compensation	55
2.1 Model number	2	5.9 Power boost mode	57
2.2 Features	2	5.10 Restore factory default setting	58
2.3 Main specification	3		
2.4 Safety overview	5	6. Protection and Failure Correction	59
2.5 Derating curve	5	6.1 Protections	59
2.6 Mechanical specification	6	6.2 Failure correction	60
3. Installation & Wiring	8	7. Warranty	61
3.1 Installation methods	8		
3.2 Installation procedures	9		
3.3 Cable selection	9		
3.4 Battery selection	10		
3.5 Serial and parallel connection of battery	10		
4. User Interface Panel	11		
4.1 Panel description	11		
4.2 Pin assignment	12		
4.3 LED indicator	13		
5. Explanation of Setting	14		
5.1 DC voltage supply	14		
5.2 DC-UPS	15		
5.3 Battery charging	15		
5.4 Communication monitoring function	20		
5.5 Alarm signals	52		
5.6 Battery Start by Battery Start Button	53		

1. Safety Guidelines

- Risk of electrical shock and energy hazard. All failure should be examined by a qualified technician. Please do not remove the case of the power supply by yourself.
- Risk of electrical arcs and electric shock (danger to life). Connecting both the primary and the secondary sides together is not allowed.
- Risk of burn hazard. Do not touch the unit in operation and shortly after disconnection.
- Risk of fire and short circuit. The openings should be protected from foreign objects or dripping liquids.
- Only install the unit in a pollution degree 2 environment (Note.1).
- Please do not install the unit in places with high moisture or near the water.
- The FG (⊕) must be connected to PE (Protective Earth).
- Disconnect system from supply voltage:
Before commencing any installation, maintenance or modification work: Disconnect your system from supply voltage. Make sure that inadvertent connection in circuit will be impossible.
- For continued protection against risk of fire, replace only with same type and rating of fuse.
- Notices for battery application
 - a. Make sure charging voltage and current meet battery's specification.
 - b. Refrain from connecting new and old batteries in series.
 - c. The cables between power supply and battery should be kept as short as possible to prevent excessive voltage drop (suggested cable length: 50cm~ 1000cm). Too much voltage drop will lead to longer charging period.
 - d. The power supply is suitable for lead-acid batteries (flooded water type, gel colloid type, AGM adsorption glass fiber) or (lithium ion, lithium manganese, lithium ternary...etc).

Note.1: Pollution Degree 2 applies where there is only non-conductive pollution that might temporarily become conductive due to occasional condensation. Generally refer to dry, well-ventilated locations, such as control cabinets.

2. Introduction

2.1 Model number

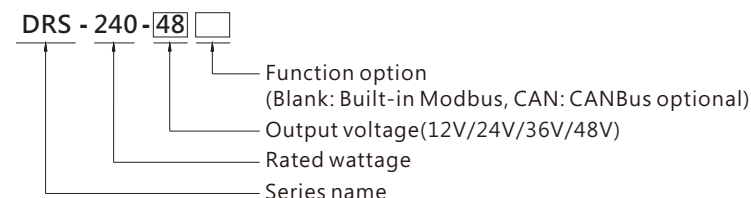

2.2 Features

- All-In-One Intelligent Security Power (Power supply, DC-UPS, battery charger and status monitoring)
- Universal input 90~305Vac with PFC (277Vac available)
- Signal and alarms design meet with UL2524, NFPA 1221, BS EN/EN54-4 and GB17945 requirement
- Priority is given to supplying power to the load to ensure that the equipment can operate normally (remaining power is used to charge the battery)
- Form C relay
- AC Fail, DC OK, Low Battery Voltage, Charging Fail detection
- Built-in Modbus communication (Optional CANBus)
- Protection: Short circuit/Over voltage/Over load/Over temperature/Battery reverse polarity (No damaged) /Battery under voltage
- Smart programmable charging parameters (with programmer SBP-001)
- 20%~100% charging current adjustable by VR
- 2 or 3-stage selectable by DIP S.W.
- Suitable for lead-acid batteries, such as flooded, Gel, AGM, and so on, or lithium-ion batteries, such as lithium ion, lithium manganese, and so on.
- -30~+70°C wide operating temperature
- LED indicator: status/abnormal indication
- DEKRA/UL/EAC (Pending)/CE/UKCA certified
- 3 years warranty

2.3 Electrical Specification

DRS-240 Series

MODEL	DRS-240-12	DRS-240-24	DRS-240-36	DRS-240-48	
OUTPUT	OUTPUT VOLTAGE <small>Note.2</small>	12V	24V	36V	48V
	CURRENT RANGE	0 ~ 20A	0 ~ 10A	0 ~ 6.6A	0 ~ 5A
	BATTERY CURRENT (CC)(max.)	15.4A	7.7A	5.1A	3.85A
	RECOMMENDED BATTERY CAPACITY(AMP HOURS) <small>Note.3</small>	20 ~ 200AH	10 ~ 100AH	6.6 ~ 66AH	5 ~ 50AH
	TOTAL OUTPUT POWER <small>Note.4</small>	Combined power on all Channels must not exceed 240W, load has priority. 275W peak capability within 5s.			
	RIPPLE & NOISE (max.) <small>Note.5</small>	150mVp-p	240mVp-p	360mVp-p	480mVp-p
	VOLTAGE TOLERANCE <small>Note.6</small>	±1.0%	±1.0%	±1.0%	±1.0%
	LINE REGULATION	±0.5%	±0.5%	±0.5%	±0.5%
	LOAD REGULATION	±0.5%	±0.5%	±0.5%	±0.5%
	SETUP, RISE TIME <small>Note.7</small>	2400ms, 1000ms/230VAC 2400ms, 1000ms/115VAC at full load			
HOLD UP TIME (Typ.)	16ms/230VAC	10ms/115VAC at full load			
INPUT	VOLTAGE RANGE	90 ~ 305VAC	127 ~ 431VDC		
	FREQUENCY RANGE	47 ~ 63Hz			
	POWER FACTOR (Typ.)	PF>0.95/230VAC	PF>0.98/115VAC at full load		
	EFFICIENCY (Typ.)	90%	92%	92%	92%
	AC CURRENT (Typ.)	2.8A/115VAC 1.4A/230VAC			
	INRUSH CURRENT (Typ.)	COLD START 30A/115VAC 60A/230VAC			
PROTECTION	SHORT CIRCUIT	Protection type: Constant current limiting, power will shutdown after 5 sec, re-power on to recover.			
	OVERLOAD	105 ~ 135% rated output power			
	OVER TEMPERATURE	Protection type: Constant current limiting, shutdown output voltage after 5 sec. Automatically drop load with temperature only for bat. load. Protection type: Shut down o/p voltage, recover automatically after temperature goes down.			
	OVER VOLTAGE	Load main output: 16.2 ~ 18.6V	Load main output: 32.4 ~ 37.3V	Load main output: 48.6 ~ 55.9V	Load main output: 64.8 ~ 74.5V
	BATTERY CUT OFF	10.5 ± 0.3V	20.9 ± 0.5V	31.3 ± 0.7V	41.8 ± 1V
	REVERSE POLARITY	By internal MOSFET, no damage, recovers automatically after fault condition is removed.			
	FUNCTION	FORM-C RELAY	AC FAIL	Signals AC failure and activates when input voltage drops below : 79~89VAC of 120AC, 132~187VAC of 220VAC. Relay contact output, ON : AC OK ; OFF : AC Fail ; max. rating : 30Vdc/1A	
CHARGER FAIL			Relay contact output, ON : Charger OK ; OFF : Charger Fail ; max. rating : 30Vdc/1A		
DC OK			Signals normal DC output and activates when output voltage > 90% rated value. Relay contact output, ON : DC OK ; OFF : DC Fail ; max. rating : 30Vdc/1A		
BATTERY LOW/ ABNORMAL/ DISCONNECTED			Relay contact output, ON : Battery OK ; OFF : Battery Low ; max. rating : 30Vdc/1A Battery low voltage: < 11 ± 0.2V Battery low voltage: < 22 ± 0.3V Battery low voltage: < 33 ± 0.4V Battery low voltage: < 44 ± 0.5V		
BATTERY START		Restart system directly from battery and does not require AC power			
DC-UPS		UPS switch to battery power within 10ms of AC failure			
ADJUSTABLE CHARGING CURRENT		20% ~ 100% charging current adjustable by VR			
ENVIRONMENT		WORKING TEMP.	-30 ~ +70°C (Refer to "Derating Curve")		
	WORKING HUMIDITY	20 ~ 90% RH non-condensing			
	STORAGE TEMP., HUMIDITY	-40 ~ +85°C, 10 ~ 95% RH non-condensing			
	TEMP. COEFFICIENT	±0.03%/°C (0 ~ 50°C) on Load output			
	VIBRATION	10 ~ 500Hz, 5G 10min./1cycle, 60min. each along X, Y, Z axes			
	OPERATING ALTITUDE <small>Note.8</small>	2000 meters / OVC III			
OTHERS	OVER VOLTAGE CATEGORY	III ; According to Dekra BS EN/EN62368-1; altitude up to 2000 meters			
	MTBF	564.7K hrs min. Telcordia SR-332 (Bellcore); 73.3K hrs min. MIL-HDBK-217F (25°C)			
	DIMENSION	85.5*125.2*129.2mm (W*H*D)			
PACKING	1.19Kg; 8pcs/ 12.5Kg / 1.08CUFT				

DRS-480 Series

MODEL	DRS-480-24	DRS-480-36	DRS-480-48	
OUTPUT	OUTPUT VOLTAGE <small>Note.2</small>	24V	36V	48V
	LOAD CURRENT RANGE	0 ~ 20A	0 ~ 13.3A	0 ~ 10A
	BATTERY CURRENT (CC)(max.)	15.4A	10.2A	7.7A
	RECOMMENDED BATTERY CAPACITY(AMP HOURS) <small>Note.3</small>	20 ~ 200AH	13 ~ 133AH	10 ~ 100AH
	TOTAL OUTPUT POWER <small>Note.4</small>	Combined power on all Channels must not exceed 480W, load has priority. 550W peak capability within 5s.		
	RIPPLE & NOISE (max.) <small>Note.5</small>	240mVp-p	360mVp-p	480mVp-p
	VOLTAGE TOLERANCE <small>Note.6</small>	±1.0%	±1.0%	±1.0%
	LINE REGULATION	±0.5%	±0.5%	±0.5%
	LOAD REGULATION	±0.5%	±0.5%	±0.5%
	SETUP, RISE TIME <small>Note.7</small>	2400ms, 1000ms/230VAC 2400ms, 1000ms/115VAC at full load		
HOLD UP TIME (Typ.)	16ms/230VAC	10ms/115VAC at full load		
INPUT	VOLTAGE RANGE	90 ~ 305VAC	127 ~ 431VDC	
	FREQUENCY RANGE	47 ~ 63Hz		
	POWER FACTOR (Typ.)	PF>0.95/230VAC	PF>0.98/115VAC at full load	
	EFFICIENCY (Typ.)	92.5%	93.5%	93.5%
	AC CURRENT (Typ.)	5.4A/115VAC 2.7A/230VAC		
	INRUSH CURRENT (Typ.)	COLD START 30A/115VAC 60A/230VAC		
PROTECTION	SHORT CIRCUIT	Protection type: Constant current limiting, power will shutdown after 5 sec, re-power on to recover.		
	OVERLOAD	105 ~ 135% rated output power		
	OVER TEMPERATURE	Protection type: Constant current limiting, shutdown output voltage after 5 sec. Automatically drop load with temperature only for bat. load. Protection type: Shut down o/p voltage, recover automatically after temperature goes down.		
	OVER VOLTAGE	Load main output: 32.4 ~ 37.3V	Load main output: 48.6 ~ 55.9V	Load main output: 64.8 ~ 74.5V
	BATTERY CUT OFF	20.9 ± 0.5V	31.3 ± 0.7V	41.8 ± 1V
	REVERSE POLARITY	By internal MOSFET, no damage, recovers automatically after fault condition is removed.		
	FUNCTION	FORM-C RELAY	AC FAIL	Signals AC failure and activates when input voltage drops below : 79~89VAC of 120AC, 132~187VAC of 220VAC. Relay contact output, ON : AC OK ; OFF : AC Fail ; max. rating : 30Vdc/1A
CHARGER FAIL			Relay contact output, ON : Charger OK ; OFF : Charger Fail ; max. rating : 30Vdc/1A	
DC OK			Signals normal DC output and activates when output voltage > 90% rated value. Relay contact output, ON : DC OK ; OFF : DC Fail ; max. rating : 30Vdc/1A	
BATTERY LOW/ ABNORMAL/ DISCONNECTED			Relay contact output, ON : Battery OK ; OFF : Battery Low ; max. rating : 30Vdc/1A Battery low voltage : < 22V ± 0.3V Battery low voltage : < 33V ± 0.4V Battery low voltage : < 44V ± 0.5V	
BATTERY START		Restart system directly from battery and does not require AC power		
DC-UPS		UPS switch to battery power within 10ms of AC failure		
ADJUSTABLE CHARGING CURRENT		20% ~ 100% charging current adjustable by VR		
ENVIRONMENT		WORKING TEMP.	-30 ~ +70°C (Refer to "Derating Curve")	
	WORKING HUMIDITY	20 ~ 90% RH non-condensing		
	STORAGE TEMP., HUMIDITY	-40 ~ +85°C, 10 ~ 95% RH non-condensing		
	TEMP. COEFFICIENT	±0.03%/°C (0 ~ 50°C) on Load output		
	VIBRATION	10 ~ 500Hz, 5G 10min./1cycle, 60min. each along X, Y, Z axes		
	OPERATING ALTITUDE <small>Note.8</small>	2000 meters / OVC III		
OTHERS	OVER VOLTAGE CATEGORY	III ; According to Dekra BS EN/EN62368-1; altitude up to 2000 meters		
	MTBF	566.6K hrs min. Telcordia SR-332 (Bellcore); 74.5K hrs min. MIL-HDBK-217F (25°C)		
	DIMENSION	110*125.2*150.7mm (W*H*D)		
PACKING	1.65Kg; 6pcs/ 11Kg / 1.42CUFT			

2.4 Safety Overview



2.5 Derating Curve

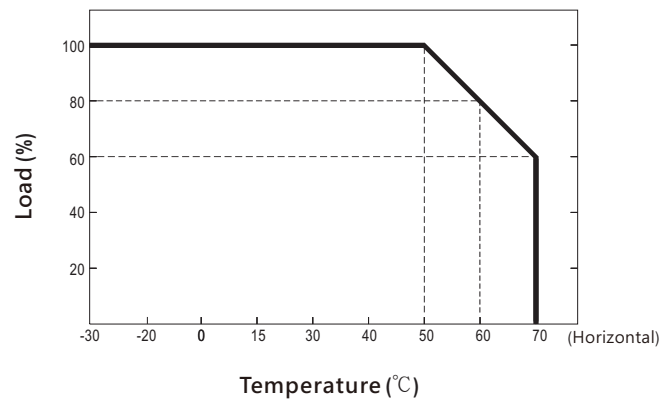

2.6 Mechanical Specification

(DRS-240 Series)

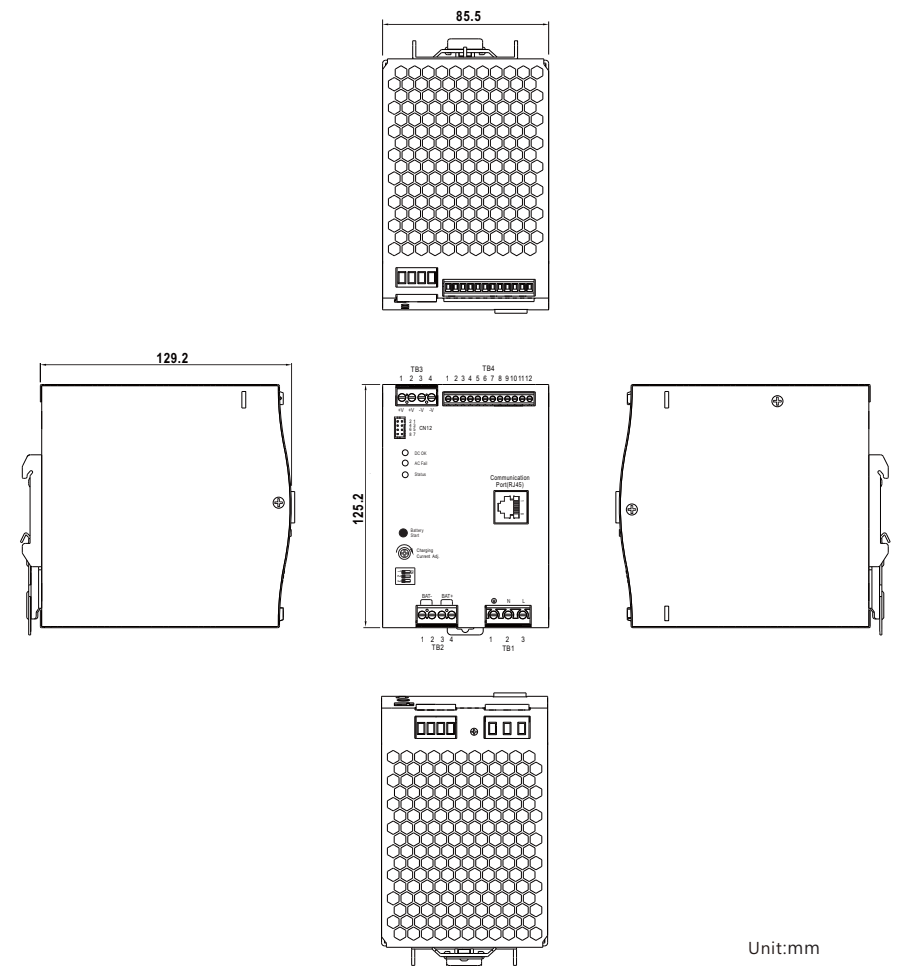

(DRS-480 Series)

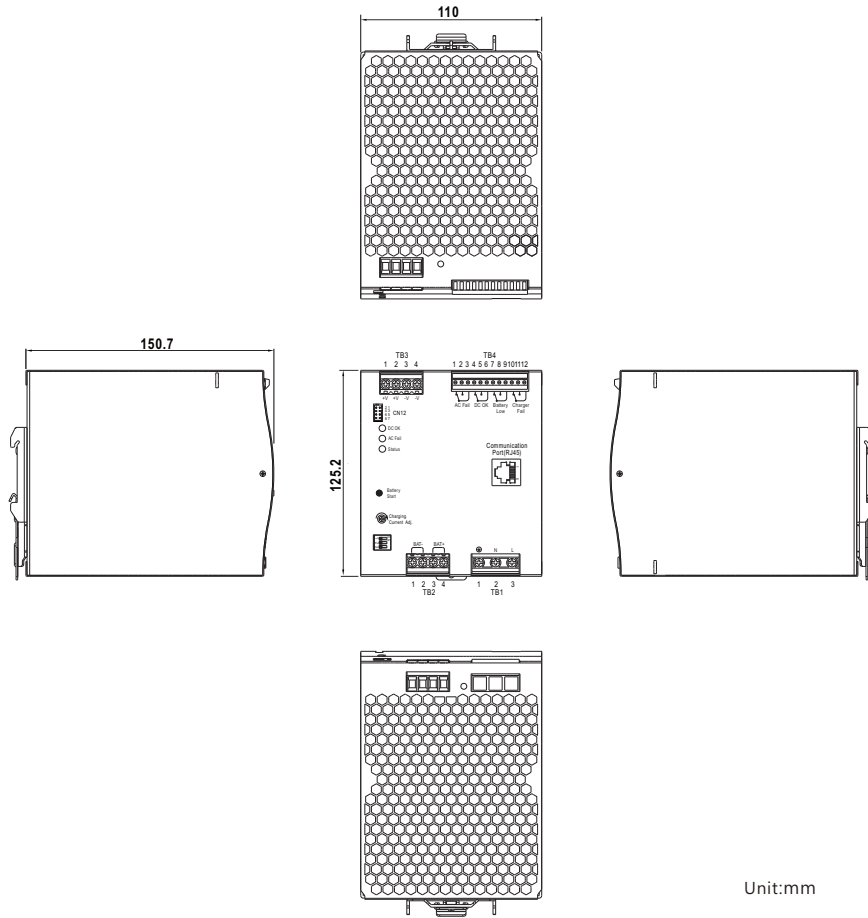

Unit:mm

3. Installation & Wiring

3.1 Installation Methods

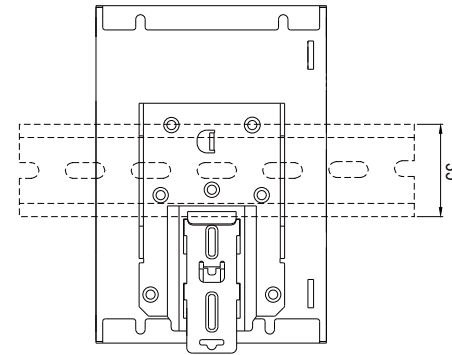

Admissible DIN rail: TS35/7.5或TS35/15
(only for reference, not included in shipment)

- ① Tilt the unit slightly rearwards
- ② Fit the unit over top hat rail
- ③ Slide it downward until it hits the stop
- ④ Press against the bottom for locking
- ⑤ Shake the unit slightly to check the locking action

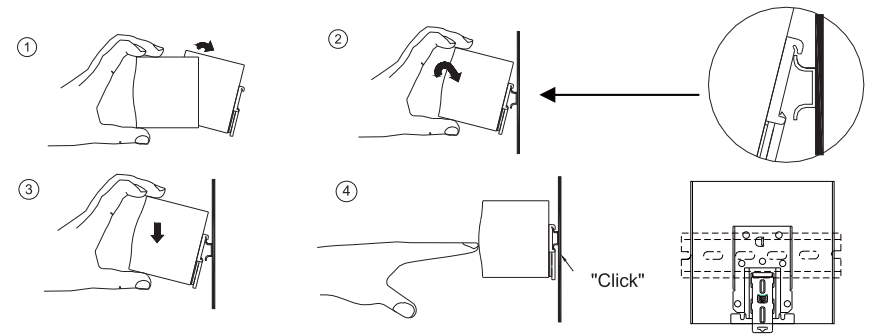

3.2 Installation Procedures

Step 1. Please connect AC input cables, DC output cables, battery charging cables, and RJ-45 communication cables(if used) to the terminal blocks of this product.



Step 2. Make sure all cables are well connected, then feeds the AC energy to the supply.

Step 3. After power-on, make sure LED indicates in green or orange, meaning normal operation. (LED status refer to Chapter 4.3)

3.3 Cable Selection

Wire connections should be as short as possible. Make sure that suitable wires are chosen based on safety requirement and rating of current. Small cross section will result in lower efficiency, less output power and the wires may also become overheated and cause danger. For selection, please refer to the following table.

AWG	Cross-section Area (mm ²)	Max.Current(A)UL1015(600V 105°C)
18	0.8	6
16	1.3	8
14	2.1	12
12	3.3	22
10	5.3	35
7	10	46
6	16	60
4	25	80
2	43	110

Recommendations for the use of wires

3.4 Battery Selection

Battery types: Lead acid or lithium ion batteries

Battery capacity: Please refer to the following table

Models	Battery capacity recommendation			
	12V	24V	36V	48V
DRS-240	20~200AH or above	10~ 100AH or above	6.6~66AH or above	5~ 50AH or above
DRS-480	/	20~200AH or above	13~133AH or above	10~100AH or above

NOTE:

- Using batteries with greater capacity than recommendation will not damage the battery, but extend charging period is expected.
- Please contact battery supplier for charging characteristics if it's not clear.

3.5 Serial and parallel connection of battery

- Serial connection: When connect 2 batteries in series, it doubled the output voltage, but the capacity remains.

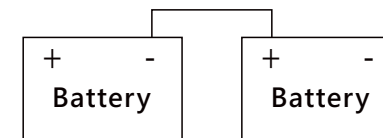

EX: 2pcs of 12V 100AH in series, become a 24V 100AH battery.

- Parallel connection: When 2 batteries connected in parallel, output voltage remains, but the capacity becomes doubled.

EX: 2pcs of 12V 100AH connect in parallel, become a 12V 200AH battery.

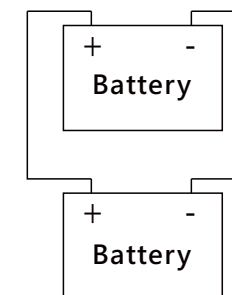

4. User Interface Panel

4.1 Panel Description

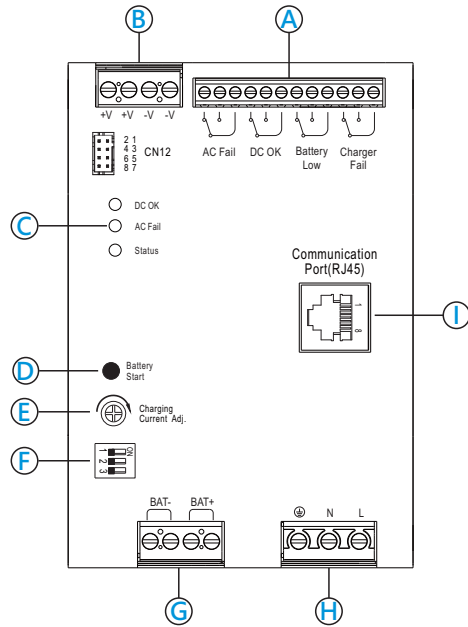

- A** Alarm signal:
It is used for monitoring function. Please refer to chapter 4.2
- B** Terminals of DC output
- C** LED indicators: To show the status of unit.
- D** Battery start button:
Restart system directly from battery and does not require AC power
- E** Io ADJ:
For charging current setting (depend on battery capacity)
- F** Charging curve setting

1	OFF:3-stage (default), ON:2-stage
2	Charging curve setting
3	

Please refer to chapter 5.3.4.1
- G** Terminals of battery connection
- H** Terminals of AC input
- I** For Modbus communication

Cable selection and suggested torque:

Terminals	Input (G)		Output (A)		Battery (F)		Control pin (C)	
	Wire	Suggested Torque	Wire	Suggested Torque	Wire	Suggested Torque	Wire	Suggested Torque
DRS-240	12-26AWG	5Kgf-cm	12-24AWG	5.7Kgf-cm	12-24AWG	5.7Kgf-cm	14-30AWG	2Kgf-cm
DRS-480	10-22AWG	10Kgf-cm	10-22AWG	8Kgf-cm	10-22AWG	8Kgf-cm	16-26AWG	2Kgf-cm

4.2 Pin Assignment

PIN definition of CN12: JS-2008R-4*2-T or equivalent

Pin	Function	Description	Connector
1	3.3V	+3.3V for programmer	
2	GND	Reference ground of communication	
3	RTH+	NTC connection	
4	RTH-		
5	A0	Address line(A1), reference to PIN2GND(Signal)	
6	A1	Address line(A0), reference to PIN2GND(Signal)	
7,8	Open: Normal Short: Force	Force start UPS function	

Terminal Pin No. Assignment (TB4)

Pin	Function	Description	Terminal
1,2,3	AC fail	Refer to chapter 5.5.1	
4,5,6	DC OK	Refer to chapter 5.5.2	
7,8,9	Battery low/ Abnormal/ Disconnected	Refer to chapter 5.5.3	
10,11,12	Charger fail	Refer to chapter 5.5.4	

Terminal Pin No. Assignment (RJ-45)

Pin	Function	Description	Rj45
1,2,3,4,5	NC	No connection	
6	Data+	Modbus mode: Communication via Modbus	
7	CANH	CANBus mode: Communication via CANBus	
	Data-	Modbus mode: Communication via Modbus	
8	CANL	CANBus mode: Communication via CANBus	
	GND-AUX	Reference GND of AUX and is isolated from the output terminal. (+V & -V)	

4.3 LED Indicator

Indicator	Description	LED indicator	
DC OK	DC fail	OFF	
	DC OK	Green	
AC fail	AC fail	Red	
	AC OK	OFF	
Status	Charging status	Float	Green
		Charging: CC/CV	Red
	System Diagnostic	Discharging	Orange: 1Blink/Pause
		Charger fail	Red: 1Blink/Pause
		Battery overvoltage/ Battery reverse polarity	Red: 2Blink/Pause
		Battery low/ No battery	Red: 3Blink/Pause
		Battery discharging peak power over timeout	Red: 4Blink/Pause
		Over load/ Short	Red: 5Blink/Pause
		Over temperature	Red: 6Blink/Pause
		Timeout	Red: 7Blink/Pause

5. Explanation of Setting

DRS series integrates multi-functions in tiny dimension, including DC output power, battery charging, DC-UPS and communication monitoring. Alarm signals, AC Fail, DC OK, battery under voltage/disconnection, charger Fail, and 2-stage or 3-stage battery charging, programmable rating of charging current from 20% to 100%, temperature compensation, etc.

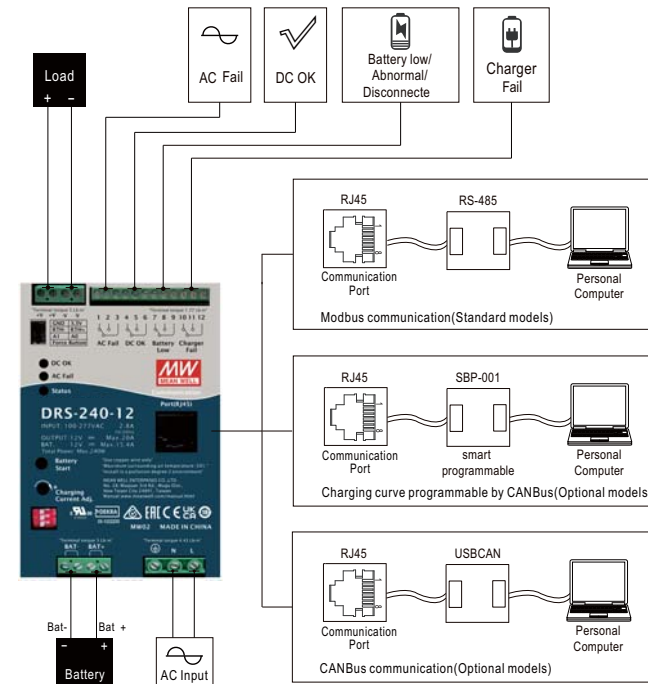

5.1 DC Voltage Supply

When power on, power supply will provide DC voltage to load first and then battery. It automatically reduces charging current to improve system stability.

5.2 DC-UPS

5.2.1. When AC mains drops below:79~89VAC of 120VAC, 132~187VAC of 220VAC, UPS function will activate and power source switch battery backup.

Note: From AC to battery, switch period is within 10ms.

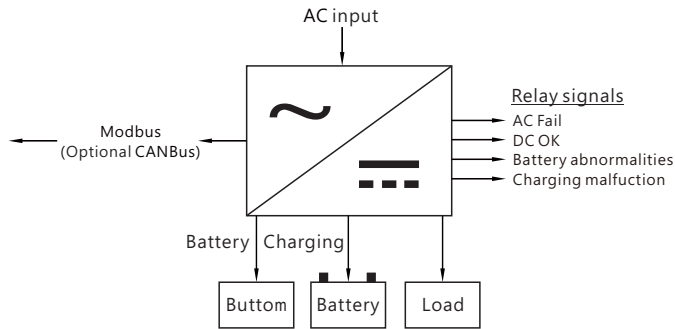

5.2.2. Back-up time

Back-up time depends on : ※ Load current
 ※ Battery capacity

Example: (C10 discharging)

Battery Load	10AH	20AH	50AH	100AH	200AH
1.5A	350min	13h	33h	67h	133h
3A	125min	350min	17h	33h	67h
5A	60min	180min	600min	20h	40h
7.5A	35min	90min	350min	13h	27h
10A	23min	60min	240min	10h	20h
15A	13min	35min	125min	350min	13h

5.3 Battery Charging

DIP switch on the panel is used for charging curve selection, 2-stage or 3-stage. 2-stage including C.C and C.V is simple fast charging. 3-stage including C.C, C.V and F.V will not turn off after 2-stage of charging finished. Users can choose between 2- or 3-stage according to the demand.

Note: DC UPS function will not be achieve in 5 seconds at first start-up.

5.3.1 2-stage charging (DIP switch on "2" stage)



In the initial stage of charging, the charger charges the battery with the maximum current, and the fan is ON (built-in fan model). After a period of time (depending on the battery capacity), the charging current gradually decreases. When the charging current drops to 10% of the rated current, LED indicator lights up in green, indicating that the charging process is complete. If the charging is finished, power supply will turn off the output of charger, but remains the output of load.

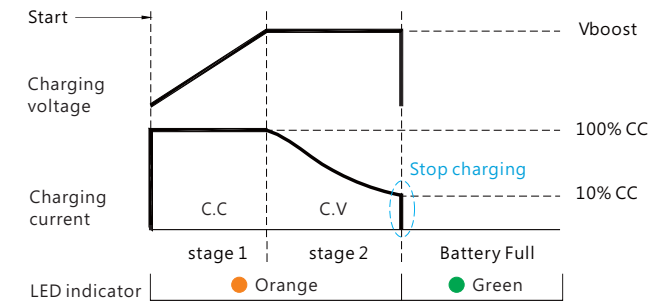

Status	DRS-240-12	DRS-240-24	DRS-240-36	DRS-240-48
C.C	15.4A	7.7A	5.1A	3.85A
Vboost	14.4V	28.8V	43.2V	57.6V

Status	DRS-480-24	DRS-480-36	DRS-480-48
C.C	15.4A	10.2A	7.7A
Vboost	28.8V	43.2V	57.6V

5.3.2 3-stage charging (DIP switch on "3" stage)



In the initial stage of charging, the charger charges the battery with the maximum current. After a period (depending on the battery capacity), the charging current gradually decreases. When the charging current drops to 10% of the rated current. LED indicator lights up in green, indicating that the charging is complete and the charger remains float charging stage.

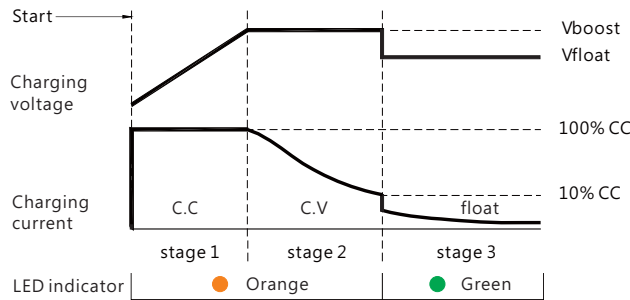

Status	DRS-240-12	DRS-240-24	DRS-240-36	DRS-240-48
C.C	15.4A	7.7A	5.1A	3.85A
Vboost	14.4V	28.8V	43.2V	57.6V
Vfloat	13.8V	27.6V	41.4V	55.2V

Status	DRS-480-24	DRS-480-36	DRS-480-48
C.C	15.4A	10.2A	7.7A
Vboost	28.8V	43.2V	57.6V
Vfloat	27.6V	41.4V	55.2V

5.3.3 Charging current adjustment

Charging current can be adjusted by the SVR on the panel from 20% to 100% rated charging current.



5.3.4 Charging curve setting

5.3.4.1 Explanation of DIP switch

The charging curve can be adjusted through the DIP switch on the panel. By following the chart below, there are both 2 and 3 stage charging curves that can be chosen accordingly.

1	OFF:3-stage (default) , ON:2-stage	
2	Refer to the following table	
3		

Built-in 2-stage charging curves

DRS-240

DIP SW		12V model		
2	3	Description	CC(default)	Vboost
OFF	OFF	Default, programmable	15.4A	14.4
ON	OFF	Pre-defined, Gel battery		14.0
OFF	ON	Pre-defined, flooded		14.2
ON	ON	Pre-defined, AGM and LiFeO4		14.6

DIP SW		24V model		
2	3	Description	CC(default)	Vboost
OFF	OFF	Default, programmable	7.7A	28.8
ON	OFF	Pre-defined, Gel battery		28.0
OFF	ON	Pre-defined, flooded		28.4
ON	ON	Pre-defined, AGM and LiFeO4		29.2

DIP SW		36V model		
2	3	Description	CC(default)	Vboost
OFF	OFF	Default, programmable	5.1A	43.2
ON	OFF	Pre-defined, Gel battery		42
OFF	ON	Pre-defined, flooded		42.6
ON	ON	Pre-defined, AGM and LiFeO4		43.8

DIP SW		48V model		
2	3	Description	CC(default)	Vboost
OFF	OFF	Default, programmable	3.85A	57.6
ON	OFF	Pre-defined, Gel battery		56.0
OFF	ON	Pre-defined, flooded		56.8
ON	ON	Pre-defined, AGM and LiFeO4		58.4

Built-in 3-stage charging curve

DRS-240

DIP SW		12V model			
2	3	Description	CC(default)	Vboost	Vfloat
OFF	OFF	Default, programmable	15.4A	14.4	13.8
ON	OFF	Pre-defined, Gel battery		14.0	13.6
OFF	ON	Pre-defined, flooded		14.2	13.4
ON	ON	Pre-defined, AGM and LiFeO4		14.6	14.0

DIP SW		24V model			
2	3	Description	CC(default)	Vboost	Vfloat
OFF	OFF	Default, programmable	7.7A	28.8	27.6
ON	OFF	Pre-defined, Gel battery		28.0	27.2
OFF	ON	Pre-defined, flooded		28.4	26.8
ON	ON	Pre-defined, AGM and LiFeO4		29.2	28.0

DIP SW		36V model			
2	3	Description	CC(default)	Vboost	Vfloat
OFF	OFF	Default, programmable	5.1A	43.2	41.4
ON	OFF	Pre-defined, Gel battery		42	40.8
OFF	ON	Pre-defined, flooded		42.6	40.2
ON	ON	Pre-defined, AGM and LiFeO4		43.8	42.0

DIP SW		48V model			
2	3	Description	CC(default)	Vboost	Vfloat
OFF	OFF	Default, programmable	3.85A	57.6	55.2
ON	OFF	Pre-defined, Gel battery		56.0	54.4
OFF	ON	Pre-defined, flooded		56.8	53.6
ON	ON	Pre-defined, AGM and LiFeO4		58.4	56.0

DRS-480

DIP SW		24V model		
2	3	Description	CC(default)	Vboost
OFF	OFF	Default, programmable	15.4A	28.8
ON	OFF	Pre-defined, Gel battery		28.0
OFF	ON	Pre-defined, flooded		28.4
ON	ON	Pre-defined, AGM and LiFeO4		29.2

DIP SW		36V model		
2	3	Description	CC(default)	Vboost
OFF	OFF	Default, programmable	10.2A	43.2
ON	OFF	Pre-defined, Gel battery		42
OFF	ON	Pre-defined, flooded		42.6
ON	ON	Pre-defined, AGM and LiFeO4		43.8

DIP SW		48V model		
2	3	Description	CC(default)	Vboost
OFF	OFF	Default, programmable	7.7A	57.6
ON	OFF	Pre-defined, Gel battery		56.0
OFF	ON	Pre-defined, flooded		56.8
ON	ON	Pre-defined, AGM and LiFeO4		58.4

NOTE: Voltage tolerance of $\pm 2\%$

DRS-480

DIP SW		24V model			
2	3	Description	CC(default)	Vboost	Vfloat
OFF	OFF	Default, programmable	15.4A	28.8	27.6
ON	OFF	Pre-defined, Gel battery		28.0	27.2
OFF	ON	Pre-defined, flooded		28.4	26.8
ON	ON	Pre-defined, AGM and LiFeO4		29.2	28.0

DIP SW		36V model			
2	3	Description	CC(default)	Vboost	Vfloat
OFF	OFF	Default, programmable	10.2A	43.2	41.4
ON	OFF	Pre-defined, Gel battery		42	40.8
OFF	ON	Pre-defined, flooded		42.6	40.2
ON	ON	Pre-defined, AGM and LiFeO4		43.8	42.0

DIP SW		48V model			
2	3	Description	CC(default)	Vboost	Vfloat
OFF	OFF	Default, programmable	7.7A	57.6	55.2
ON	OFF	Pre-defined, Gel battery		56.0	54.4
OFF	ON	Pre-defined, flooded		56.8	53.6
ON	ON	Pre-defined, AGM and LiFeO4		58.4	56.0

NOTE: Voltage tolerance of $\pm 2\%$

5.3.4.2 Setting by communication

Users can set charging parameters via Modbus or CANBus(optional) including constant current, voltage, float voltage, taper current, battery temperature compensation and charge time, etc. Refer to chapter 5.4 for details.

5.3.4.3 Smart charging curve programming by SBP-001 (only for CANBus models)

SBP- 001 is a smart battery charging programmer developed by MEAN WELL, which can set the charging curves of the DRS series through editing software. SBP-001 provides functions such as charging curve adjustment and battery temperature compensation. Please set the DIP switch pin to Default, programmable (PIN2: OFF; PIN3 : OFF) before use. Configuration and software interface are shown as below. Please refer to “SBP-001 Smart Battery Charging Programmer User Manual” for details.

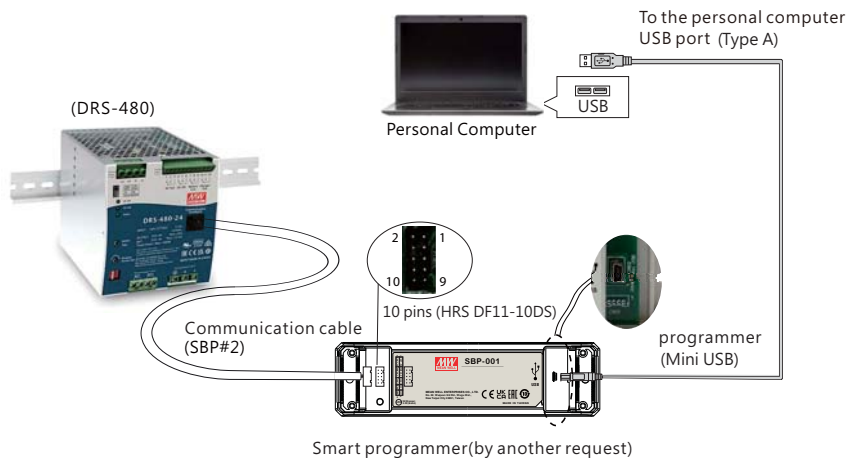

Programmable charging curve

Model selection

Time out

5.4 Communication Monitoring Function

5.4.1 Modbus Communication

The Modbus protocol can be used to read status and control settings of the all-in-on security powers (slave), including operation on/off, output voltage/current adjustment and internal temperature reading. In addition, charge curves and relative charge parameters of constant current, constant voltage, float voltage, taper current, battery temperature compensation and charge time. Output can also be adjusted when set in the charge mode.

5.4.1.1 Modbus specifications

Modbus communication interface

This device supports Modbus RTU with the master-slave principle. During data transfer, please follow the principle of first sending the High byte and then the Low byte except Error Check(CRC-16 checksum).

Physical Layer setting as below:

Control	Setting
Baud Rate	115200
Data Bits	8
Stop Bits	1
Parity	None
Flow Control	None

5.4.1.2 Communication Interface

- Min. request period (Controller to PSU/CHG): 50mSec ◦
- Max. response time (PSU/CHG to Controller): 12.5mSec ◦
- Min. packet margin time (Controller to PSU/CHG): 12.5mSec ◦

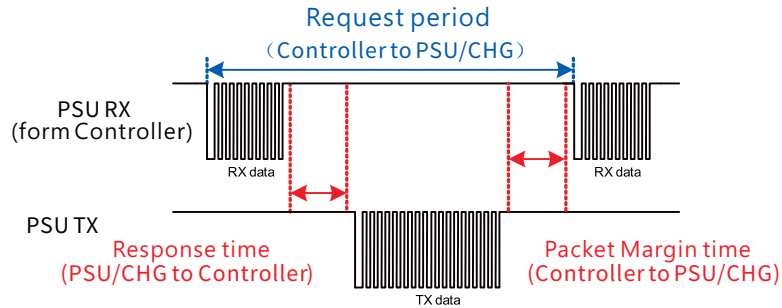

5.4.1.3 Modbus Frame Encapsulation

Modbus RTU consists of Additional Address, Function Code, Date and Error Check.

Additional address	Function code	Data	Error check
1 byte	1 byte	N bytes	2 bytes

- Additional address (1byte): defines PSU slave ID
- Function code (1byte): The function code is used to tell the slave what kind of action to perform.
- Data (N bytes): For data exchange, contents and data length are dependent on different function codes.
- Error Check (2bytes): utilizes CRC-16.

5.4.1.4 Additional Address Definition

Additional address is the slave ID of the device. Each DRS unit should have their unique and own device address to communicate over the bus. Slave ID is set by CN12 (A0~A1)
The device address is set as follows:

Between A0/A1 and GND (Single)	logic
Open	1
Short	0

Device No.	Device address	
	A1	A0
0	0	0
1	0	1
2	1	0
3	1	1

Slave ID	Description
0x8X	X means device address
0x00	Broadcast

Note: Broadcast is only for command write but not read.

5.4.1.5 Function Code Description

The main purpose of the function codes is to tell the slave what kind of action to perform. For example, function code 03 will query the slave to read holding registers and respond the master server with their contents.

Function Code of DRS as follow :

Function Code	Description	
Read Holding Register	0x03	Parameter register read
Read Input Register	0x04	Analog register reads
Preset Single Register	0x06	Write to single staging area

5.4.1.6 Data field and command lists

Data field provides additional information by the slave to complete the action specified by the function code in a request. The data field typically includes register addresses, count values, and written data. There are two forms according to the function codes.

FC=03/04

Starting Address	Quantity of (Input) Registers
2 Bytes	2 Bytes

FC=06

Register Addressr	Register Value
2 Bytes	2 Bytes

The following is data description of register addresses.

Register address	# of data Bytes	Command Name	Description	Function code	Value	unit
0x0000	2	OPERATION	Remote ON/OFF control	0x03、0x06	0x00(OFF)/0x01(ON)	-
0x0020	2	VOUT_SET	Output voltage set	0x03、0x06	Refer to 5.4.4	V
0x0040	2	FAULT_STATUS	Abnormal status	0x03	Refer to transmission data description	-
0x0050	2	READ_VIN	Input voltage read value	0x04	Refer to 5.4.4	V
0x0060	2	READ_VOUT	Output voltage	0x04	Refer to 5.4.4	V
0x0061	2	READ_IOUT	Output current	0x04	Refer to 5.4.4	A
0x0062	2	READ_TEMPERATURE_1	Internal ambient	0x04	Refer to 5.4.4	°C
0x0080~0x0082	6	MFR_ID_B0B5	Manufacture's name	0x03	Refer to transmission data description	ASCII
0x0083~0x0085	6	MFR_ID_B6B11	Manufacture's name	0x03	Refer to transmission data description	ASCII
0x0086~0x0088	6	MFR_MODEL_B0B5	Manufacture model name	0x03	Refer to transmission data description	ASCII
0x0089~0x008B	6	MFR_MODEL_B6B11	Manufacture model name	0x03	Refer to transmission data description	ASCII
0x008C~0x008E	6	MFR_REVISION_B0B5	Firmware version	0x03	Refer to transmission data description	Binary
0x008F~0x0090	4	MFR_LOCATION_B0B2	Manufacture place	0x03、0x06	TWN/CHN	ASCII
0x0091~0x0093	6	MFR_DATE_B0B5	Manufacture date	0x03、0x06	Refer to transmission data description	ASCII
0x0094~0x0096	6	MFR_SERIAL_B0B5	Manufacture serial number	0x03、0x06	Refer to transmission data description	ASCII
0x0097~0x0099	6	MFR_SERIAL_B6B11	Manufacture serial number	0x03、0x06	Refer to transmission data description	ASCII
0x00B0	2	CURVE_CC	Constant current setting (only for charger)	0x03、0x06	Refer to 5.4.4	A
0x00B1	2	CURVE_CV	Constant voltage setting (only for charger)	0x03、0x06	Refer to 5.4.4	V
0x00B2	2	CURVE_FV	Floating voltage setting (only for charger)	0x03、0x06	Refer to 5.4.4	V

0x00B3	2	CURVE_TC	Taper current setting (only for charger)	0x03、0x06	Refer to 5.4.4	A
0x00B4	2	CURVE_CONFIG	Configuration setting (only for charger)	0x03、0x06	Refer to transmission data description	-
0x00B5	2	CURVE_CC_TIMEOUT	CC charge timeout setting (only for charger)	0x03、0x06	Refer to 5.4.4	Min
0x00B6	2	CURVE_CV_TIMEOUT	CV charge timeout setting	0x03、0x06	Refer to 5.4.4	Min
0x00B7	2	CURVE_FV_TIMEOUT	FV charge timeout setting (only for charger)	0x03、0x06	Refer to 5.4.4	Min
0x00B8	2	CHG_STATUS	Charging status reporting (only for charger)	0x03	Refer to transmission data description	-
0x00C0~0x00C2	6	SCALING_FACTOR	Scaling ratio	0x03	Refer to transmission data description	-
0x00C3	2	SYSTEM_STATUS	System status	0x03	Refer to transmission data description	-
0x00C4	2	SYSTEM_CONFIG	System configuration	0x03、0x06	Refer to transmission data description	-
0x00D0	2	BAT_UVP_SET	BAT_LOW protect setting	0x03、0x06	Refer to 5.4.4	V
0x00D1	2	Force_BAT_UVP_SET	Force BAT_LOW protect setting	0x03、0x06	Refer to 5.4.4	V
0x00D2	2	UPS_CONFIG	UPS config setting	0x03、0x06	Refer to transmission data description	-
0x00D3	2	READ_VBAT	Voltage of battery	0x04	Refer to 5.4.4	V
0x00D4	2	READ_IBAT	Charging or discharging current of battery	0x04	Refer to 5.4.4	A
0x00D5	2	READ_BAT_TEMPERATURE	Temperature of battery	0x04	Refer to 5.4.4	°C
0x00E0	2	AC_Fail_LL_SET	AC fail low line point setting	0x03、0x06	Refer to 5.4.4	V
0x00E1	2	AC_Fail_HL_SET	AC fail high line point setting	0x03、0x06	Refer to 5.4.4	V
0x00E2	2	AC_OK_LL_SET	AC OK low line point setting	0x03、0x06	Refer to 5.4.4	V
0x00E3	2	AC_OK_HL_SET	AC OK high line point setting	0x03、0x06	Refer to 5.4.4	V
0x00E4	2	TIME_BUFFERING	Buffering time setting	0x03、0x06	Refer to 5.4.4	Min

Transmission data description:

The conversion of setting and reading values is defined as following:

Actual value = Communication reading value × F actor (F value).

Among them Factor needs to refer to the definition of SCALING_FACTOR in each model list.

EX: Vo_real(actual DC voltage) = READ_VOUT × F actor.

If the Factor of READ_VOUT of a certain model is 0.01, the communication reading value is 0x0960(hexadecimal) → 2400(decimal), then Vo_real = 2400 × 0.01 = 24.00V.

◎ **FAULT_STATUS(0x0040)** :

	Bit7	Bit6	Bit5	Bit4	Bit3	Bit2	Bit1	Bit0
High byte	Reserved	Reserved	Reserved	Reserved	Reserved	Reserved	Reserved	Reserved
Low byte	HI_TEMP	OP_OFF	AC_FAIL	SHORT	OLP	OVP	OTP	FAN_FAIL

Low byte

Bit 0 FAN_FAIL: Fan abnormal state (Not support)

0 = Normal state

1 = abnormal state

Bit 1 OTP: Over temperature protection

0 = Normal internal temperature

1 = Abnormal internal temperature

Bit 2 OVP: Output over-voltage protection

0 = Normal output voltage

1 = Abnormal output voltage

Bit 3 OLP: Output over current protection

0 = Normal output current

1 = Abnormal output current

Bit 4 SHORT: Short circuit protection

0 = Shorted circuit does not exist

1 = Shorted circuit protected

Bit 5 AC_FAIL: AC abnormal flag

0 = Normal AC range

1 = Abnormal AC range

Bit 6 OP_OFF: DC status

0 = DC turned on

1 = DC turned off

Bit 7 HI_TEMP: High ambient temperature protection

0 = Normal ambient temperature

1 = Abnormal ambient temperature

High byte: Bit 0:7

Reserved: Currently not in use, retain (default is 0)

Note: Unsupported settings displays with "0"

◎ **MFR_ID_B0B5(0x0080-0x0082)** is the first 6 codes of the manufacturer's name (ASCII);

MFR_ID_B6B11(0x0083-0x0085) is the last 6 codes of the manufacturer's name (ASCII)

EX: manufacturer's name is MEANWELL → MFR_ID_B0B5 is MEANWE;

MFR_ID_B6B11 is LL

MFR_ID_B0B5					
Byte 0	Byte 1	Byte 2	Byte 3	Byte 4	Byte 5
0x4D	0x45	0x41	0x4E	0x57	0x45

MFR_ID_B6B11					
Byte 0	Byte 1	Byte 2	Byte 3	Byte 4	Byte 5
0x4C	0x4C	0x20	0x20	0x20	0x20

◎ **MFR_MODEL_B0B5 (0x0086 – 0x0088)** is the first 6 codes of the manufacturer's model name (ASCII);

MFR_MODEL_B6B11 (0x0089 – 0x008B) is the last 6 codes of the manufacturer's model name (ASCII)

EX: Model name is DRS-480-24 → MFRMODEL_B0B5 is DRS-48;

MFR_MODEL_B6B11 is 0-24

MFR_MODEL_B0B5					
Byte 0	Byte 1	Byte 2	Byte 3	Byte 4	Byte 5
0x44	0x52	0x53	0x2D	0x34	0x38

MFR_ID_B6B11					
Byte 6	Byte 7	Byte 8	Byte 9	Byte 10	Byte 11
0x30	0x2D	0x32	0x34	0x20	0x20

◎ **MFR_REVISION_B0B5(0x008C-0x008E)** is the firmware version. Arange of hexadecimal 0x00(R00.0)~0xFE(R25.4) represents the firmware version of an MCU; 0xFF represents no MCU existed.

EX1: The power supply has six MCUs. The firmware version of the MCU number 1 is version R01.3(0x0D), the MCU number 2 is version R01.2(0x0C), the MCU number 3 is version R01.1(0x0B), the other MCU numbers are version R01.0(0x0A).

Byte 0	Byte 1	Byte 2	Byte 3	Byte 4	Byte 5
0x0D	0x0C	0x0B	0x0A	0x0A	0x0A

EX2: The power supply has three MCUs. The firmware version of the MCU number 1 is version R25.4(0xFE), the MCU number 2 is version R10.5(0x69), the MCU number 3 is version R01.0(0x0A).

Byte 0	Byte 1	Byte 2	Byte 3	Byte 4	Byte 5
0xFE	0x69	0x0A	0xFF	0xFF	0xFF

◎ **MFR_DATE_B0B5(0x0091-0x0093)** is manufacture date (ASCII)

EX: MFR_DATE_B0B5 is 180101, meaning 2018/01/01

Byte 0	Byte 1	Byte 2	Byte 3	Byte 4	Byte 5
0x31	0x38	0x30	0x31	0x30	0x31

◎ **MFR_SERIAL_B0B5(0x0094-0x0096) · MFR_SERIAL_B6B11 (0x0097-0x0099)** are defined as manufacture date and manufacture serial number (ASCII)

EX: The first unit manufactured on 2018/01/01→MFR_SERIAL_B0B5: 180101; MER_SERIAL_B6B11: 000001

Byte 0	Byte 1	Byte 2	Byte 3	Byte 4	Byte 5
0x31	0x38	0x30	0x31	0x30	0x31

Byte 0	Byte 1	Byte 2	Byte 3	Byte 4	Byte 5
0x30	0x30	0x30	0x30	0x30	0x31

◎ **CURVE_CONFIG(0x00B4)(only for charger)** :

	Bit7	Bit6	Bit5	Bit4	Bit3	Bit2	Bit1	Bit0
High byte	Reserved	Reserved	Reserved	Reserved	Reserved	FVTOE	CVTOE	CCTOE
Low byte	CUVE	STGS	Reserved	Reserved	TCS		CUVS	

Low byte:

Bit 0:1 CUVS: Charge Curve Selection

00 = Customized charge curve (default)

01 = Gel battery

10 = Flooded battery

11 = AGM battery

Bit 2:3 TCS: Temperature Compensation Setting

00 = disable

01 = -3 mV/°C/cell (default)

10 = -4 mV/°C/cell

11 = -5 mV/°C/cell

Bit 4:5 Reserved: Currently not in use, retain (default is 0)

Bit 6 STGS: 2/3 Stage Charge setting (Not support)

0 = 3 stage charge (default, CURVE_CV and CURVE_FV)

1 = 2 stage charge (only CURVE_CV)

Bit 7 CUVE: Charge Curve Function Enable (default is 1)

0 = OFF (VI mode)

1 = ON (Curve mode)

High byte:

Bit 0 CCTOE: Constant current stage timeout indication enable

0 = OFF (default)

1 = ON

Bit 1 CVTOE : Constant voltage stage timeout indication enable

0 = OFF (default)

1 = ON

Bit 2 FTTOE : Floating voltage stage timeout indication enable

0 = OFF (default)

1 = ON

Bit 3:7 Reserved: currently not in use, retain (default is 0)

Note: Not support settings display with "0"

© CHG_STATUS(0x00B8)(only for charger) :

	Bit7	Bit6	Bit5	Bit4	Bit3	Bit2	Bit1	Bit0
Highbyte	FVTOF	CVTOF	CCTOF	BUFFTOF	BTNC	NTCER	Reserved	Reserved
Lowbyte	DCM	Reserved	Reserved	Reserved	FVM	CVM	CCM	FULLM

Low byte:

- Bit 0 FULLM: Fully charged mode status
0 = NOT fully charged
1 = Fully charged
- Bit 1 CCM: Constant current mode status
0 = The charger NOT in constant current mode
1 = The charger in constant current mode
- Bit 2 CVM: Constant voltage mode status
0 = The charger NOT in constant voltage mode
1 = The charger in constant voltage mode
- Bit 3 FVM: Float mode status
0 = The charger NOT in float mode
1 = The charger in float mode
- Bit 4:6 Reserved: Currently not in use, retain (default is 0)
- Bit 7 DCM: Battery discharge mode
0 = Charging
1 = Discharging

High byte:

- Bit 0:1 Reserved: Currently not in use, retain (default is 0)
- Bit 2 NTCER: Temperature compensation status
0 = NO short-circuit in the circuitry of temperature compensation
1 = the circuitry of temperature compensation has short-circuited
- Bit 3 BTNC: Battery detection
0 = Battery detected
1 = NO battery detected
- Bit 4 BUFFTOF: Time out flag of buffering
0 = NO time out in buffering
1 = Buffering time out

- Bit 5 CCTOF: Time out flag of constant current mode
0 = NO time out in constant current mode
1 = Constant current mode time out
- Bit 6 CVTOF : Time out flag of constant voltage mode
0 = NO time out in constant voltage mode
1 = Constant voltage mode time out
- Bit 7 FVTOF: Time out flag of float mode
0 = NO time out in float mode
1 = Float mode time out

Note: Not support settings display with "0"

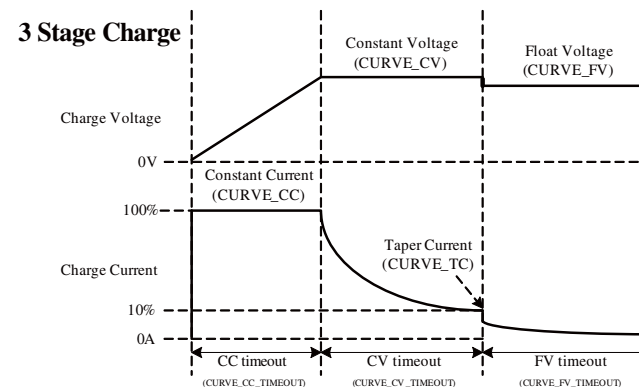
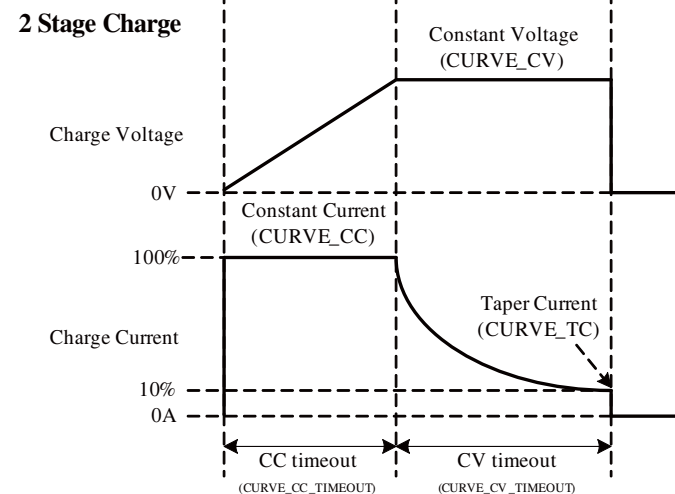

© SCALING_FACTOR(0x00C0-0x00C2) :

	Bit7	Bit6	Bit5	Bit4	Bit3	Bit2	Bit1	Bit0
Byte5	Reserved				Reserved			
	Bit7	Bit6	Bit5	Bit4	Bit3	Bit2	Bit1	Bit0
Byte4	Reserved				Reserved			
	Bit7	Bit6	Bit5	Bit4	Bit3	Bit2	Bit1	Bit0
Byte3	Reserved				IIN Factor			
	Bit7	Bit6	Bit5	Bit4	Bit3	Bit2	Bit1	Bit0
Byte2	CURVE_TIMEOUT Factor				TEMPERATURE_1 Factor			
	Bit7	Bit6	Bit5	Bit4	Bit3	Bit2	Bit1	Bit0
Byte1	FAN_SPEED Factor				VIN Factor			
	Bit7	Bit6	Bit5	Bit4	Bit3	Bit2	Bit1	Bit0
Byte0	IOUT Factor				VOUT Factor			

Byte0:

Bit 0:3 VOUT Factor : The factor of output voltage

- 0x0=Not support output voltage relevant commands
- 0x1~0x3=Currently not in use, retain (default is 0)
- 0x4=0.001
- 0x5=0.01
- 0x6=0.1
- 0x7=1.0
- 0x8=10
- 0x9=100
- 0xA~0xF= Reserved

Bit 4:7 IOUT Factor : The factor of DC current

- 0x0=Not support output current relevant commands
- 0x1~0x3=Currently not in use, retain (default is 0)
- 0x4=0.001
- 0x5=0.01
- 0x6=0.1
- 0x7=1.0
- 0x8=10
- 0x9=100
- 0xA~0xF= Reserved

Byte1:

Bit 0:3 VIN Factor : The factor of AC input voltage

- 0x0=Not support AC input relevant commands
- 0x1~0x3=Currently not in use, retain (default is 0)
- 0x4=0.001
- 0x5=0.01
- 0x6=0.1
- 0x7=1.0
- 0x8=10
- 0x9=100
- 0xA~0xF= Reserved

Bit 4:7 FAN_SPEED Factor : The factor of fan speed

- 0x0=Not support fan speed relevant commands
- 0x1~0x3=Currently not in use, retain (default is 0)
- 0x4=0.001
- 0x5=0.01
- 0x6=0.1
- 0x7=1.0
- 0x8=10
- 0x9=100
- 0xA~0xF= Reserved

Byte2:

Bit 0:3 TEMPERATURE_1 Factor : The factor of internal ambient temperature

- 0x0=Not support internal ambient temperature relevant commands
- 0x1~0x3=Currently not in use, retain (default is 0)
- 0x4=0.001
- 0x5=0.01
- 0x6=0.1
- 0x7=1.0
- 0x8=10
- 0x9=100
- 0xA~0xF= Reserved

Bit 4:7 CURVE_TIMEOUT Factor : The factor of CC/CV/Float timeout

- 0x0=Not support CURVE_TIMEOUT relevant commands
- 0x1~0x3=Currently not in use, retain (default is 0)
- 0x4=0.001
- 0x5=0.01
- 0x6=0.1
- 0x7=1.0
- 0x8=10
- 0x9=100
- 0xA~0xF= Reserved

Byte3:

Bit 0:3 IIN Factor : The factor of AC input current

- 0x0=Not support AC input current relevant commands
- 0x1~0x3=Currently not in use, retain (default is 0)
- 0x4=0.001
- 0x5=0.01
- 0x6=0.1
- 0x7=1.0
- 0x8=10
- 0x9=100
- 0xA~0xF= Reserved

Bit 4:7 Reserved : Currently not in use, retain (default is 0)

Byte4~Byte5:

Bit 0:7 Reserved : Currently not in use, retain (default is 0)

◎ SYSTEM_STATUS(0x00C3) :

	Bit7	Bit6	Bit5	Bit4	Bit3	Bit2	Bit1	Bit0
High byte	Reserved	Reserved	Reserved	Reserved	Reserved	Reserved	Reserved	Reserved
Low byte	CHG/UPS	EEPER	INITIAL_STATE	ADL_ON	ORING_OFF	PFC_OK	DC_OK	M/S

Low byte:

- Bit 0 M/S : Parallel mode (Not support)
 - 0 = Slave
 - 1 = Master
- Bit 1 DC_OK : Secondary DC output voltage status
 - 0 = Secondary DD output voltage status TOO LOW
 - 1 = Secondary DD output voltage status NORMAL
- Bit 2 PFC_OK : Primary side PFC output voltage status (Not support)
 - 0 = Primary side PFC no starting or abnormal
 - 1 = Primary side PFC normal
- Bit 3 ORING_OFF : ORING MOS OFF (Not support)
 - 0 = DD start-up, ORING MOS controller ON
 - 1 = DD start-up, force control ORING MOS OFF
- Bit 4 ADL_ON : Active dummy load control state (Not support)
 - 0 = Active dummy load OFF/Not support
 - 1 = Active dummy load ON
- Bit 5 INITIAL_STATE : Device initialized status
 - 0 = In initialization status
 - 1 = NOT in initialization status
- Bit 6 EEPER : EEPROM data access error
 - 0 = Normal EEPROM data access
 - 1 = Abnormal EEPROM data access
- Bit 7 CHG/UPS : Operation status
 - 0 = Charging mode
 - 1 = UPS mode

High byte:

Bit 0:7 Reserved : Currently not in use, retain (default is 0)

Note: Not support settings display with "0"

◎ SYSTEM_CONFIG(0x00C4) :

	Bit7	Bit6	Bit5	Bit4	Bit3	Bit2	Bit1	Bit0
High byte	Reserved	Reserved	Reserved	Reserved	Reserved	Reserved	Reserved	Reserved
Low byte	Reserved	Reserved	Reserved	Reserved	Reserved	OPERATION_INIT		MOD_CTRL

Low byte:

- Bit 0 MOD_CTRL : Modbus control status (Not support)
0 = SVR
1 = Modbus (VOUT_SET, IOUT_SET, OPERATION)
- Bit 1:2 OPERATION_INIT : Pre-set value of power on operation command
0b00 = Power OFF, pre-set 0x00(OFF)
0b01 = Power ON, pre-set 0x01(ON)
0b10 = Pre-set is previous set value
0b11 = Reserved, currently not in use
- Bit 3:7 Reserved : Currently not in use, retain (default is 0)

High byte:

- Bit 0:7 Reserved : Currently not in use, retain (default is 0)

Note: Not support settings display with "0"

© UPS_CONFIG(0x00D2) :

	Bit7	Bit6	Bit5	Bit4	Bit3	Bit2	Bit1	Bit0
High byte	Reserved	Reserved	Reserved	Reserved	Reserved	Reserved	Reserved	Reserved
Low byte	Reserved	Reserved	Reserved	Reserved	Reserved	Time_ Buff_EN	UPS_ OFF_EN	Life_ Test_EN

Low byte:

- Bit 0 Life_Test_EN : Battery self-test function
0 = OFF
1 = ON(default)
- Bit 1 UPS_OFF_EN : Force start state via button to shut down
0 = OFF(default)
1 = ON
- Bit 2 Time_Buff_EN : Time_Buffering setting function
0 = OFF(default)
1 = ON
- Bit 3:7 Reserved : Currently not in use, retain (default is 0)

High byte :

- Bit 0:7 Reserved : Currently not in use, retain (default is 0)

Note: Not support settings display with "0"

5.4.2 Communication examples

The following provides examples of request and response for each function code of the Modbus RTU.

5.4.2.1 Read Holding Register (FC=03)

The request message specifies the starting register and quantity of registers to be read.

For example: the master requests the content of analog output holding registers 0x0080~0x0085 (MFR_ID_B0B5, MFR_ID_B6B11) from slave 3.

Request:

0x83	0x03	0x00 80	0x00 06	0xDA 02
------	------	---------	---------	---------

0x83 : Slave ID 3

0x03 : Function code 3 (Read analog output holding R registers)

0x00 80 : The data address of the first register requested

0x00 06 : The total number of registers requested (Read 6 registers 0x0080~ 0x0085)

0xDA 02 : CRC-16 error check. Please be aware that CRC sending the low byte first.

Response :

0x83	0x03	0x0C	0x4D 45 41 4E 57 45 4C 4C 20 20 20 20	0x4A 8C
------	------	------	---------------------------------------	---------

0x83 : Slave ID 3

0x03 : Function code 3 (Read analog output holding R registers)

0x0C : The number of data bytes to follow (12 bytes)

0x4D 45 41 4E 57 45 4C 4C 20 20 20 20 : means that the manufacture name of the slave is MEAN WELL

0x4A 8C: CRC-16 error check. Please be aware that CRC sending the Low byte first.

5.4.2.2 Read Input Register (FC=04)

The request message specifies the starting register and quantity of registers to be read.

For example: The master requests the content of analog input register 0x0060 (READ_VOUT) from slave 3.

Request:

0x83	0x04	0x00 60	0x00 01	0x2F F6
------	------	---------	---------	---------

0x83 : Slave ID 3

0x04 : Function code 4 (Read analog input registers)

0x00 60 : The data address of the first register requested

0x00 01 : The total number of registers requested (Read only 1 register from 0x0060)

0x2F F6 : CRC-16 error check. Please be aware that CRC sending the Low byte first.

Response :

0x83	0x04	0x02	0x15 7C	0xCE 5F
------	------	------	---------	---------

0x83 : Slave ID 3

0x04 : Function code 4 (Read analog input register)

0x02 : The number of data bytes to follow (2 bytes)

0x15 7C : The contents of register: HEX 0x15 7C = DEC 5500 = 55.00V

0xCE 5F: CRC-16 error check. Please be aware that CRC sending the Low byte first.

5.4.2.3 Write Single Register (FC=06)

The request message specifies the register reference to be written.

For example: the master writes PSU ON to analog output holding register of 0x0000 (OPERATION) for slave 3.

Request:

0x83	0x06	0x00 00	0x00 01	0x56 28
------	------	---------	---------	---------

0x83 : Slave ID 3

0x06 : Function code 6 (Pre-set single register)

0x00 00 : The data address of the register

0x00 01 : The value to write

0x56 28 : CRC-16 error check. Please be aware that CRC sending the Low byte first.

Response :

The normal response is an echo of the query, returned after the register contents have been written.

5.4.3 CANBus communication

- Physical layer

This protocol complies with CAN ISO-11898, and baud rate is 250Kbps.

- Protocol frame format

The protocol complies with CAN 2.0B, the extended frame format.

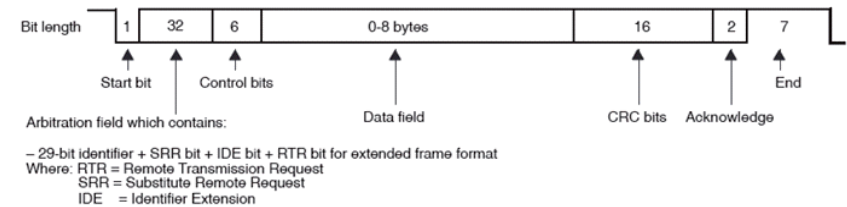

- Communication interface

Min. request period (Controller to PSU/CHG): 20mSec ◦

Max. response time (PSU/CHG to Controller): 5mSec ◦

Min. packet margin time (Controller to PSU/CHG): 5mSec ◦

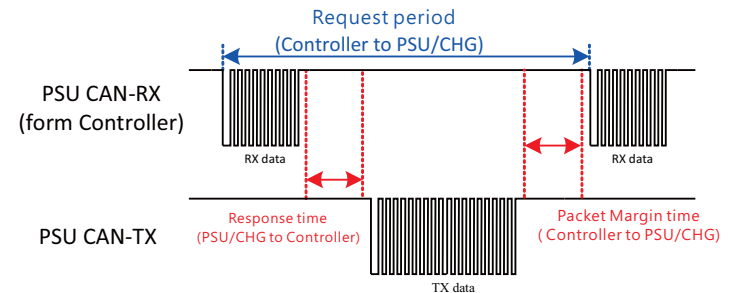

5.4.3.1 Message ID

Description	Message ID
Message ID of DRS	0x000C00XX
Message ID of Master	0x000C01XX
Broadcast	0x000C01FF

PS : XX means device address of DRS (depend on A0~A1, from 0x00 to 0x03)

5.4.3.2 CANBus command list

Command Code	Command Name	Transaction Type	# of data Bytes	Description
0x0000	OPERATION	R/W	1	Remote ON/OFF
0x0020	VOUT_SET	R/W	2	Output voltage set (format: value, F=0.01)
0x0040	FAULT_STATUS	R	2	Abnormal status
0x0050	READ_VIN	R	2	Input voltage read value (format: value, F=0.1)
0x0060	READ_VOUT	R	2	Output voltage (format: value, F=0.01)
0x0061	READ_IOUT	R	2	Output current (format: value, F=0.01)
0x0062	READ_TEMPERATURE_1	R	2	Internal ambient temperature (format: value, F=0.1)
0x0080	MFR_ID_B0B5	R	6	Manufacture's name
0x0081	MFR_ID_B6B11	R	6	Manufacture's name
0x0082	MFR_MODEL_B0B5	R	6	Manufacture model
0x0083	MFR_MODEL_B6B11	R	6	Manufacture model
0x0084	MFR_REVISION_B0B5	R	6	Firmware version
0x0085	MFR_LOCATION_B0B2	R/W	3	Manufacture place
0x0086	MFR_DATE_B0B5	R/W	6	Manufacture date

0x0087	MFR_SERIAL_B0B5	R/W	6	Manufacture serial number
0x0088	MFR_SERIAL_B6B11	R/W	6	Manufacture serial number
0x00B0	CURVE_CC	R/W	2	Constant current setting (format: value, F=0.01)
0x00B1	CURVE_CV	R/W	2	Constant voltage setting (format: value, F=0.01)
0x00B2	CURVE_FV	R/W	2	Floating voltage setting (format: value, F=0.01)
0x00B3	CURVE_TC	R/W	2	Taper current setting (format: value, F=0.01)
0x00B4	CURVE_CONFIG	R/W	2	Configuration setting
0x00B5	CURVE_CC_TIMEOUT	R/W	2	CC charge timeout setting
0x00B6	CURVE_CV_TIMEOUT	R/W	2	CV charge timeout setting
0x00B7	CURVE_FV_TIMEOUT	R/W	2	FV charge timeout setting
0x00B8	CHG_STATUS	R	2	Charging status reporting (only for charger)
0x00C0	SCALING_FACTOR	R	2	Scaling ratio
0x00C1	SYSTEM_STATUS	R	2	System status
0x00C2	SYSTEM_CONFIG	R/W	2	System configuration
0x00D0	BAT_UVP_SET	R/W	2	BAT_LOW protect setting
0x00D1	Force_BAT_UVP_SET	R/W	2	Force BAT_LOW protect setting
0x00D2	UPS_CONFIG	R/W	2	UPS config setting
0x00D3	READ_VBAT	R	2	Voltage of battery (format: value, F=0.01)

0x00D4	READ_IBAT	R	2	Charging or discharging current of battery (format: value, F=0.01)
0x00D5	READ_BAT_TEMPERATURE	R	2	Temperature of battery (format: value, F=0.1)
0x00D6	CHARGE CYCLES	R/W	2	Charge cycles (Not support)
0x00D7	AH CHARGED	R/W	2	Battery capacity (Not support)
0x00E0	AC_Fail_LL_SET	R/W	2	AC fail low line point setting
0x00E1	AC_Fail_HL_SET	R/W	2	AC fail high line point setting
0x00E2	AC_OK_LL_SET	R/W	2	AC OK low line point setting
0x00E3	AC_OK_HL_SET	R/W	2	AC OK high line point setting
0x00E4	TIME_BUFFERING	R/W	2	Buffering time setting
0x00E5	BACKUP	R/W	2	Backup power counting (Not support)
0x00E6	RUN TIME	R/W	4	Running time (Not support)

Note: The conversion of setting and reading values is defined as following:

Actual value= Communication reading value ×F actor (F value).

Among them Factor needs to refer to the definition of SCALING_FACTOR in each model list.

EX: $V_{o_real}(\text{actual DC voltage}) = \text{READ_VOOUT} \times F \text{ actor}$.

If the Factor of READ_VOOUT of a certain model is 0.01, the communication reading value is 0x0960(hexadecimal)→2400(decimal), then $V_{o_real} = 2400 \times 0.01 = 24.00V$.

◎ FAULT_STATUS(0x0040) :

Bit7	Bit6	Bit5	Bit4	Bit3	Bit2	Bit1	Bit0
High byte	Reserved	Reserved	Reserved	Reserved	Reserved	Reserved	Reserved
Low byte	OP_OFF	AC_FAIL	SHORT	OLP	OVP	OTP	FAN_FAIL

Low byte:

Bit 0 FAN_FAIL : Fan abnormal state (Not support)

0 = Normal state

1 = Abnormal state

Bit 1 OTP : Over temperature protection

0 = Normal internal temperature

1 = Abnormal internal temperature

Bit 2 OVP : Output over-voltage protection

0 = Normal output voltage

1 = Abnormal output

Bit 3 OLP : Output over current protection

0 = Normal output current

1 = Abnormal output current

Bit 4 SHORT : Short circuit protection

0 = Shorted circuit does not exist

1 = Shorted circuit protected

Bit 5 AC_FAIL : AC abnormal flag

0 = Normal AC range

1 = Abnormal AC range

Bit 6 OP_OFF : DC status

0 = DC turned on

1 = DC turned off

Bit 7 HI_TEMP : High ambient temperature protection

0 = Normal ambient temperature

1 = Abnormal ambient temperature

High byte:

Bit 0:7 Reserved : Currently not in use, retain (default is 0)

Note: Unsupported settings displays with "0"

- ◎ **MFR_ID_B0B5(0x0080)** is the first 6 codes of the manufacturer's name (ASCII);
MFR_ID_B6B11(0x0081) is the last 6 codes of the manufacturer's name (ASCII)

EX: manufacturer's name is MEANWELL→MFR_ID_B0B5 is MEANWE;
MFR_ID_B6B11 is LL

MFR_ID_B0B5					
Byte 0	Byte 1	Byte 2	Byte 3	Byte 4	Byte 5
0x4D	0x45	0x41	0x4E	0x57	0x45

MFR_ID_B6B11					
Byte 0	Byte 1	Byte 2	Byte 3	Byte 4	Byte 5
0x4C	0x4C	0x20	0x20	0x20	0x20

- ◎ **MFR_MODEL_B0B5(0x0082)** is the first 6 codes of the manufacturer's model name (ASCII);
MFR_MODEL_B6B11(0x0083) is the last 6 codes of the manufacturer's model name (ASCII)

EX: Model name is DRS-480-24→MFRMODEL_B0B5 is DRS-48;
MFR_MODEL_B6B11 is 0-24

MFR_MODEL_B0B5					
Byte 0	Byte 1	Byte 2	Byte 3	Byte 4	Byte 5
0x44	0x52	0x53	0x2D	0x34	0x38

MFR_ID_B6B11					
Byte 6	Byte 7	Byte 8	Byte 9	Byte 10	Byte 11
0x30	0x2D	0x32	0x34	0x20	0x20

- ◎ **MFR_REVISION_B0B5(0x0084)** is the firmware version. Arrange of hexadecimal 0x00(R00.0)~0xFE(R25.4) represents the firmware version of an MCU; 0xFF represents no MCU existed.

EX1: The power supply has six MCUs. The firmware version of the MCU number 1 is version R01.3(0x0D), the MCU number 2 is version R01.2(0x0C), the MCU number 3 is version R01.1(0x0B), the other MCU numbers are version R01.0(0x0A)

Byte 0	Byte 1	Byte 2	Byte 3	Byte 4	Byte 5
0x0D	0x0C	0x0B	0x0A	0x0A	0x0A

EX2: The power supply has three MCUs. The firmware version of the MCU number 1 is version R25.4(0xFE), the MCU number 2 is version R10.5(0x69), the MCU number 3 is version R01.0(0x0A).

Byte 0	Byte 1	Byte 2	Byte 3	Byte 4	Byte 5
0xFE	0x69	0x0A	0xFF	0xFF	0xFF

- ◎ **MFR_DATE_B0B5(0x0086)** is manufacture date (ASCII)

EX: MFR_DATE_B0B5 is 180101, meaning 2018/01/01

Byte 0	Byte 1	Byte 2	Byte 3	Byte 4	Byte 5
0x31	0x38	0x30	0x31	0x30	0x31

- ◎ **MFR_SERIAL_B0B5(0x0087)**、**MFR_SERIAL_B6B11(0x0088)** are defined as manufacture date and manufacture serial number (ASCII)

EX: The first unit manufactured on 2018/01/01→MFR_SERIAL_B0B5: 180101; MER_SERIAL_B6B11: 000001

Byte 0	Byte 1	Byte 2	Byte 3	Byte 4	Byte 5
0x31	0x38	0x30	0x31	0x30	0x31

Byte 0	Byte 1	Byte 2	Byte 3	Byte 4	Byte 5
0x30	0x30	0x30	0x30	0x30	0x31

- ◎ **CURVE_CONFIG(0x00B4)(only for charger)** :

Bit0								
High byte	Reserved	Reserved	Reserved	Reserved	Reserved	FVTOE	CVTOE	CCTOE
Lowbyte	CUVE	STGS	Reserved	Reserved	TCS	CUVS		

Low byte:

Bit 0:1 CUVS : Charge Curve Selection

00 = Customized charge curve (default)

01 = Gel battery

10 = Flooded battery

11 = AGM battery

Bit 2:3 TCS : Temperature Compensation Setting

00 = disable

01 = -3 mV/°C/cell (default)

10 = -4 mV/°C/cell

11 = -5 mV/°C/cell

Bit 4:5 Reserved : Currently not in use, retain (default is 0)

Bit 6 STGS : 2/3 Stage Charge setting (Not support)

0 = 3 stage charge (default, CURVE_CV and CURVE_FV)

1 = 2 stage charge (only CURVE_CV)

Bit 7 CUVE : Charge Curve Function Enable (default is 1)

0 = OFF(VI mode)

1 = ON(Curve mode)

High byte:

Bit 0 CCTOE : Constant current stage timeout indication enable

0 = OFF (default)

1 = ON

Bit 1 CVTOE : Constant voltage stage timeout indication enable

0 = OFF (default)

1 = ON

Bit 2 FTTOE : Floating voltage stage timeout indication enable

0 = OFF (default)

1 = ON

Bit 3:7 Reserved : Currently not in use, retain (default is 0)

Note: Not support settings display with "0"

© CHG_STATUS(0x00B8)(only for charger) :

	Bit7	Bit6	Bit5	Bit4	Bit3	Bit2	Bit1	Bit0
Highbyte	FVTOF	CVTOF	CCTOF	BUFFTOF	BTNC	NTCER	Reserved	Reserved
Low byte	DCM	Reserved	Reserved	Reserved	FVM	CVM	CCM	FULLM

Low byte:

Bit 0 FULLM : Fully charged mode status

0 = NOT fully charged

1 = Fully charged

Bit 1 CCM : Constant current mode status

0 = The charger NOT in constant current mode

1 = The charger in constant current mode

Bit 2 CVM : Constant voltage mode status

0 = The charger NOT in constant voltage mode

1 = The charger in constant voltage mode

Bit 3 FVM : Float mode status

0 = The charger NOT in float mode

1 = The charger in float mode

Bit 4:6 Reserved : Currently not in use, retain (default is 0)

Bit 7 DCM : Battery discharge mode

0 = Charging

1 = Discharging

High byte:

Bit 0:1 Reserved : Currently not in use, retain (default is 0)

Bit 2 NTCER : Temperature compensation status

0 = NO short-circuit in the circuitry of temperature compensation

1 = the circuitry of temperature compensation has short-circuited

Bit 3 BTNC : Battery detection

0 = Battery detected

1 = NO battery detected

Bit 4 BUFFTOF : Time out flag of buffering

0 = NO time out in buffering

1 = Buffering time out

Bit 5 CCTOF : Time out flag of constant current mode

0 = NO time out in constant current mode

1 = Constant current mode time out

Bit 6 CVTOF : Time out flag of constant voltage mode

0 = NO time out in constant voltage mode

1 = Constant voltage mode time out

Bit 7 FVTOF : Time out flag of float mode

0 = NO time out in float mode

1 = Float mode time out

Note: Not support settings display with "0"

Diagram of charging curve:

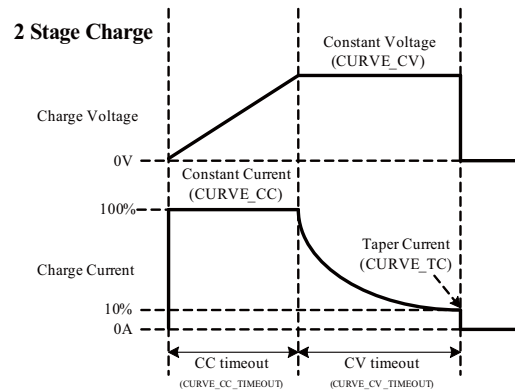
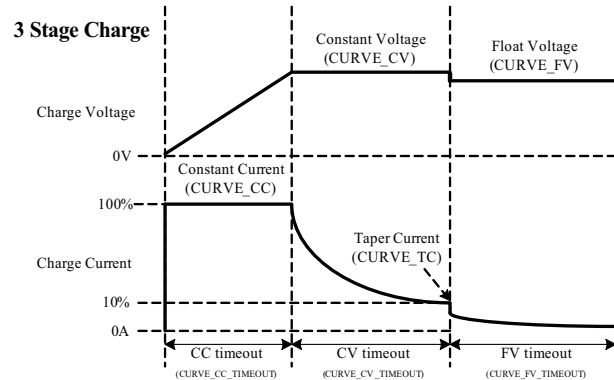

© SYSTEM_STATUS(0x00C1):

	Bit7	Bit6	Bit5	Bit4	Bit3	Bit2	Bit1	Bit0
High byte	Reserved	Reserved	Reserved	Reserved	Reserved	Reserved	Reserved	Reserved
Low byte	CHG/UPS	EEPER	INITIAL_STATE	ADL_ON	ORING_OFF	PFC_OK	DC_OK	M/S

Low byte:

Bit 0 M/S : Parallel mode (Not support)

0 = Slave

1 = Master

Bit 1 DC_OK : Secondary DC output voltage status

0 = Secondary DD output voltage status TOO LOW

1 = Secondary DD output voltage status NORMAL

Bit 2 PFC_OK : Primary side PFC output voltage status (Not support)

0 = Primary side PFC no starting or abnormal

1 = Primary side PFC normal

Bit 3 ORING_OFF : ORING MOS OFF (Not support)

0 = DD start-up, ORING MOS controller ON

1 = DD start-up, force control ORING MOS OFF

Bit 4 ADL_ON : Active dummy load control state (Not support)

0 = Active dummy load OFF/Not support

1 = Active dummy load ON

Bit 5 INITIAL_STATE : Device initialized status

0 = In initialization status

1 = NOT in initialization status

Bit 6 EEPEER : EEPROM data access error

0 = Normal EEPROM data access

1 = Abnormal EEPROM data access

Bit 7 CHG/UPS : Operation status

0 = Charging mode

1 = UPS mode

High byte:

Bit 0:7 Reserved : Currently not in use, retain (default is 0)

Note: Not support settings display with "0"

© SYSTEM_CONFIG(0x00C2):

	Bit7	Bit6	Bit5	Bit4	Bit3	Bit2	Bit1	Bit0
High byte	Reserved	Reserved	Reserved	Reserved	Reserved	Reserved	Reserved	Reserved
Low byte	Reserved	Reserved	Reserved	Reserved	Reserved	Reserved	OPERATION_INIT	CAN_CTRL

Low byte:

Bit 0 CAN_CTRL : CANBus control status (Not support)

0 = SVR

1 = CANBus(VOUT_SET, IOUT_SET, OPERATION)

Bit 1:2 OPERATION_INIT : Pre-set value of power on operation command

0b00 = Power OFF, pre-set 0x00(OFF)

0b01 = Power ON, pre-set 0x01(ON)

0b10 = Pre-set is previous set value

0b11 = Reserved, currently not in use

Bit 3:7 Reserved : Currently not in use, retain (default is 0)

High byte:

Bit 0:7 Reserved : Currently not in use, retain (default is 0)

Note: Not support settings display with "0"

© UPS_CONFIG(0x00D2) :

	Bit7	Bit6	Bit5	Bit4	Bit3	Bit2	Bit1	Bit0
High byte	Reserved	Reserved	Reserved	Reserved	Reserved	Reserved	Reserved	Reserved
Lowbyte	Reserved	Reserved	Reserved	Reserved	Reserved	Time_ Buff_EN	UPS_ OFF_EN	Life_ Test_EN

Low byte:

Bit 0 Life_Test_EN : Battery self-test function

0 = OFF

1 = ON(default)

Bit 1 UPS_OFF_EN : Force start state via button to shut down

0 = OFF(default)

1 = ON

Bit 2 Time_Buff_EN : Time_Buffering setting function

0 = OFF(default)

1 = ON

Bit 3:7 Reserved : Currently not in use, retain (default is 0)

High byte :

Bit 0:7 Reserved : Currently not in use, retain (default is 0)

Note: Not support settings display with "0"

5.4.4 Range and tolerance of values

(1) Reading parameters

	CANBus /Modbus Command	Model	Range	Tolerance	
0x0050	READ_VIN	ALL	80 ~305V	±2V	
0x0060	READ_VOUT	12V	0 ~15V	±0.12V	
		24V	0 ~30V	±0.24V	
		36V	0 ~45V	±0.36V	
		48V	0 ~60V	±0.48V	
0x0061	READ_IOUT	DRS-240	12V	0 ~20A	±0.2A
			24V	0 ~10A	±0.1A
			36V	0 ~6.6A	±0.066A
			48V	0 ~5A	±0.05A
		DRS-480	24V	0 ~20A	±0.2A
			36V	0 ~13.3A	±0.13A
			48V	0 ~10A	±0.1A
			0x0062	READ_TEMPERATURE_1	ALL
0x00D3	READ_VBAT	12V	0 ~ 15V	±0.12V	
		24V	0 ~ 30V	±0.24V	
		36V	0 ~ 45V	±0.36V	
		48V	0 ~ 60V	±0.48V	
0x00D4	READ_IBAT	DRS-240	12V	-40~20A	±0.2A
			24V	-20~10A	±0.1A
			36V	-13.2~6.6A	±0.066A
			48V	-10~5A	±0.05A
		DRS-480	24V	-40~20A	±0.2A
			36V	-26.6~13.3A	±0.13A
			48V	-40~20A	±0.1A
			0x00D5	READ_BAT_TEMPERATURE	ALL

(2) Writing parameters

1	CANBus/ Modbus Command	Model	Range	Tolerance	Default	
0x0000	OPERATION	ALL	00h(OFF)/01h (ON)	N/A	01h(ON)	
0x0020	VOUT_SET	12V	10 ~ 14V	±0.12V	12V	
		24V	20 ~ 28V	±0.24V	24V	
		36V	30 ~ 42V	±0.36V	36V	
		48V	40~56V	±0.48V	48V	
0x00B0	CURVE_ICHG	DRS-240	12V	4 ~ 20A	±0.2A	20A
			24V	2 ~ 10A	±0.1A	10A
			36V	1.32 ~ 6.6A	±0.066A	6.6A
			48V	1 ~ 5A	±0.05A	5A

0x00B0	CURVE_ICHG	DRS-480	24V	4 ~ 20A	±0.2A	20A
			36V	2.66 ~ 13.3A	±0.13A	13.3A
			48V	2 ~ 10A	±0.1A	10A
0x00B1	CURVE_VBST	12V	9 ~ 15V	±0.12V	14.4V	
		24V	18 ~ 30V	±0.24V	28.8V	
		36V	27 ~ 45V	±0.36V	43.2V	
		48V	36 ~ 60V	±0.48V	57.6V	
0x00B2	CURVE_VFLOAT	12V	9V ~ VBST	±0.12V	13.8V	
		24V	18V ~ VBST	±0.24V	27.6V	
		36V	27V ~ VBST	±0.36V	41.4V	
		48V	36V ~ VBST	±0.48V	55.2V	
0x00B3	CURVE_ITAPER	DRS-240	12V	0.4 ~ 2A	±0.2A	2A
			24V	0.2 ~ 1A	±0.1A	1A
			36V	0.13 ~ 0.66A	±0.066A	0.66A
		DRS-480	48V	0.1 ~ 0.5A	±0.05A	0.5A
			24V	0.4 ~ 2A	±0.2A	2A
			36V	0.27 ~ 1.33A	±0.133A	1.33A
48V	0.2 ~ 1A	±0.1A	1A			
0x00B5	CURVE_CC_TIME OUT	ALL	60 ~ 64800 minute	±5 minute	600 minute	
0x00B6	CURVE_CV_TIME OUT					
0x00B7	CURVE_FLOAT_TIMEOUT					
0x00D0	BAT_UVP_SET	12V	9.6 ~ 12V	±0.12V	10.44V	
		24V	19.2 ~ 24V	±0.24V	20.88V	
		36V	28.8 ~ 36V	±0.36V	31.32V	
		48V	38.4 ~ 48V	±0.48V	41.76V	
0x00D1	Force_BAT_UVP_SET	12V	8.4 ~ 12V	±0.12V	8.4V	
		24V	16.8 ~ 24V	±0.24V	16.8V	
		36V	25.2 ~ 36V	±0.36V	25.2V	
		48V	33.6 ~ 48V	±0.48V	33.6V	
0x00E0	AC_Fail_LL_SET	ALL	82 ~ 120V	±5V	82Vac	
0x00E1	AC_Fail_HL_SET	ALL	132 ~ 182V	±5V	171.6Vac	
0x00E2	AC_OK_LL_SET	ALL	87~125V	±5V	87Vac	
0x00E3	AC_OK_HL_SET	ALL	137 ~ 187V	±5V	182.6Vac	
0x00E4	TIME_BUFFERING	ALL	60 ~ 64800 minute	±5 minute	600 minute	

5.5 Alarm Signals

Alarm signals: AC Fail, DC OK, Battery Low, Abnormality, Disconnection of batteries, and Charger Fail.

INPUT	AC Fail		DC OK		Battery low/Abnormal /Disconnected		Charger Fail	
	2-3	1-3	5-6	4-6	8-9	7-9	11-12	10-12
AC only	closed	open	closed	open	open	closed	-----	-----
AC + BAT.	closed	open	closed	open	closed	open	-----	-----
BAT. only	open	closed	closed	open	closed	open	-----	-----
Low BAT. (<30% capacity)	-----	-----	-----	-----	open	closed	-----	-----
Charger Fail	-----	-----	-----	-----	-----	-----	open	closed

1. Relays of " AC Fail " , " DC OK " , " Battery Low " or " Charger Fail " will be triggered according to different abnormal condition.
2. An external voltage source is needed, and maximum voltage is 30Vdc and sinking current is 1A.

AC Fail/DC OK/Battery Low/Charger Fail

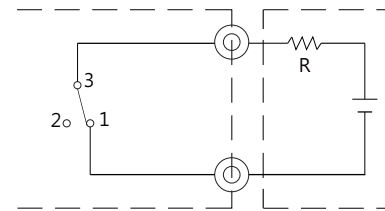

External voltage(V) and resistance(R)
(Maximal sinking current is 1A at 30V)

5.5.1 AC Fail signal

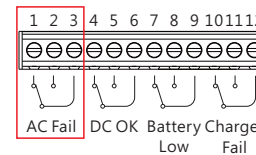

Status	2-3	1-3
Only supply by main power	Short	Open
Supply by main power and back-up power (battery)	Short	Open
Only supply by back-up power (battery)	Open	Short

5.5.2 DC OK signal

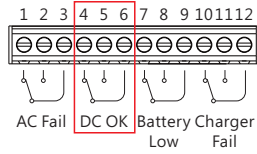

Status	5-6	4-6
Normal DC output	Short	Open
DC fail	Open	Short

5.5.3 Battery Low, reverse polarity, disconnected battery signal

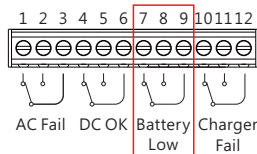

Status	8-9	7-9
Normal battery voltage	Short	Open
Low	Open	Short

5.5.4 Charger Fail signal

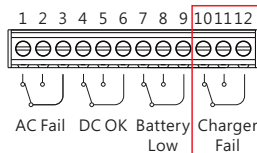

Status	11-12	10-12
Normal charging	Short	Open
Abnormal	Open	Short

5.6 Battery Start by Battery Start Button

The function of the mode is to restart the system directly from the existed battery or a replaced one and this does not require AC power to activate.

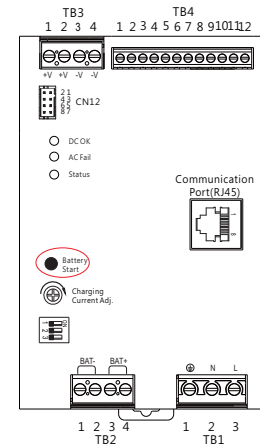

- 5.6.1 Short press the Battery Start button to connect to the battery to start the mode.
- 5.6.2 Long pressing the Battery Start button for 3sec can release the connection from the battery to deactivate the mode.
- 5.6.3 Battery under-voltage protection will be triggered and then disconnecting from the battery when battery voltage drops below a certain value(12V: 10.5±0.3V; 24V:20.9±0.5; 36V:31.3±0.7V; 48V : 41.8±1V)
- 5.6.4 In the mode, if there is AC power fed in, the supply will switch to using AC energy and then recharge the battery automatically.

5.7 Battery Start by Force Button

The function of the mode is to restart the system directly from the existed battery or a replaced one and this does not require AC power to activate.

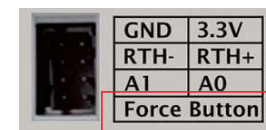

- 5.7.1 Short-circuit PIN 7 and PIN 8 of CN12 together to activate the mode (after activation, it is recommended to disconnect the connection in order not to interfere in the function of 5.7.2) Short circuit on PIN7 and PIN8 of CN12(Open or remain shorted).
- 5.7.2 Long pressing the Battery Start button for 3sec can release the connection from the battery to deactivate the mode.
- 5.7.3 Battery under-voltage protection will be triggered and then disconnecting the battery when battery voltage drops below a certain value (12V : $10\pm 0.3V$; 24V : 16.8 ± 0.5 ; 36V : $25.2\pm 0.7V$; 48V : $33.6\pm 1V$)
- 5.7.4 In the mode, if there is AC power fed in, the supply will switch to using AC energy and then recharge the battery automatically.

5.8 Battery Temperature Compensation

The main function of temperature compensation is to reduce the influences of temperature on battery. Using this function, please put the shipped temperature sensor (NTC) on the battery or near it. DRS can work normally without temperature sensor (NTC) .

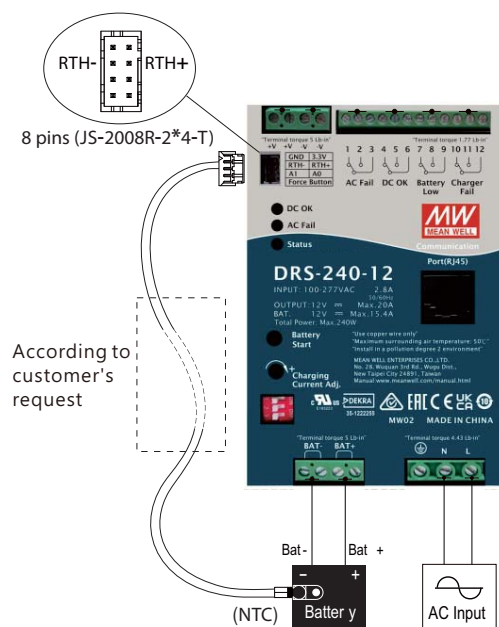

- 5.8.1. CANBus and Modbus commands can modify parameters of temperature compensation. There are four selections, Disable, $-3mV/^{\circ}C/Cell$, $-4mV/^{\circ}C/Cell$ and $-5mV/^{\circ}C/Cell$, and default setting is $-3mV/^{\circ}C/Cell$.
- 5.8.2. No compensation if temperature sensor disconnected. Only Lead-acid batteries can use this compensation.
- 5.8.3. Temperature range for compensation is $0-40^{\circ}C$. No compensation at middle value $25^{\circ}C$ and temperature $<0^{\circ}C$ or $>40^{\circ}C$ will be limited at the maximum and minimum boundary. For 24V model as example, assume V_{boost} is 28.8V, compensation parameter is $-5mV/^{\circ}C/Cell$, TEMP_bat is the sensing temperature of NTC, then compensated voltage can be calculated below.

$$V_{boost_comp} = 28.8V - 5mV * (TEMP_bat - 25^{\circ}C) * 12Cell$$

$$V_{boost_H} = 28.8V - 5mV * (0^{\circ}C - 25^{\circ}C) * 12Cell = 30.3V$$

$$V_{boost_L} = 28.8V - 5mV * (40^{\circ}C - 25^{\circ}C) * 12Cell = 27.9V$$

5.8.4 Accessories

※ Standard accessories of DRS: NTC sensor and remote-control cable

	Item	Amount
1	<p>NTC sensor</p> <p>Part No.: NGS05C250J5</p>	1
2	<p>Remote-control cable</p>	1
<p>Conne</p> <p>To DRS panel</p> <p>According to customer's requiremen</p> <p>Connect</p> <p>To battery</p>		

5.9 Power Boost Mode

5.9.1 No battery connection

Power supply can remain 115% of rated power, then shut down after 5 sec.

5.9.2 With battery connected

The maximum current on the load output is the 2 times the rated current for 4 minutes max.

The maximum current on the load output is the 3 times the rated current for 4 seconds max.

For example (48V model):

- When maximum output current draw doubles the rated current, the maximum output period is 4 minutes, and 4 seconds at triple current draw.

Output power



- Taking 10 minutes as cycle unit, the period of double power can not exceed 6 minutes or triple less than 6 seconds – otherwise DRS will automatically shut down for protection.

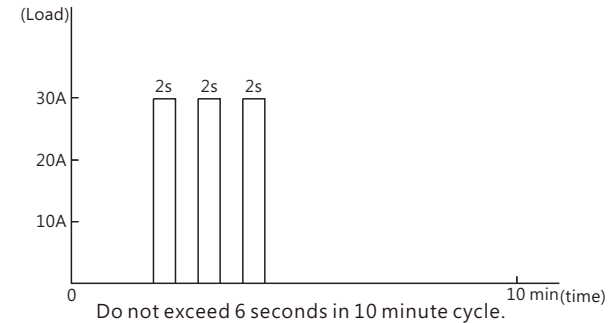
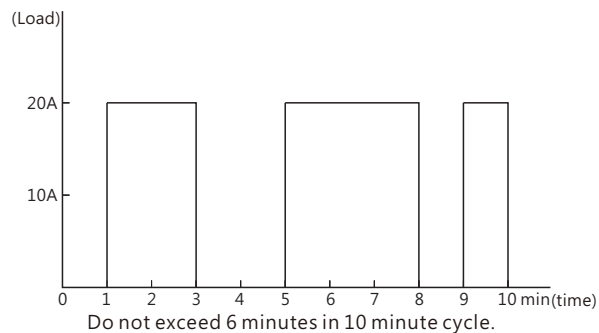

5.10 Restore Factory Default Setting

User can reset the power supply restore factory default setting via 0x0000, 0x0020, 0x0030, 0x00B0~0x00B7, 0x00C2, 0x00E0~0x00E4 commands.

- After supplying AC input power AC, shortly push Bat_start button 5 times in 15 seconds.
- LED indicator (Status indicator) will flash 3 times in green and that means the setting is succeeded.
- Recycle the supply to restore factory default setting.

6. Protection and Failure Correction

6.1 Protections

6.1.1 Over load protection

When output current reaches the protection criteria, power supply will limit its output as constant current, and shut down for protection after 5 seconds. Re-power on to recover.

6.1.2 Over temperature protection

When the internal temperature of power supply is too high, power supply will shut down for protection and it will turn on automatically if the temperature is back to normal range.

In charging mode, when the internal temperature of power supply is too high, power supply will automatically decrease output power according to the derating curve, chapter 2.5. If the temperature is still too high over limitation, power supply will shut down and recover once the temperature cool down.

6.1.3 Output over voltage protection

When output voltage over specification, over voltage protection will be activated, and power supply shuts down. When the faulty condition removed, re-power on to remove the protection.

6.1.4 Battery under voltage protection

When the voltage of battery is too low, power supply will shut down.

Model	Protection limitation
12V	10.5 ±0.3V
24V	20.9 ±0.5V
36V	31.3±0.7V
48V	41.8±1.0V

Note: If battery under-voltage protection is triggered by force button, please refer to 5.7.3.

6.1.5 Reverse polarity protection

Power supply has built-in MOSFETs to achieve reverse polarity protection. When the faulty condition removed, power supply will automatically recover without damage.

6.2 Failure Correction

Status	Possible cause	Suggestion for fault correction
Battery back-up failure	Un-connected, low voltage battery	Check connection, specification of battery, or change battery
Battery start failure	Button: low battery voltage/reverse connection	Check connection or change new battery
	CN12: bad connection	Make sure PIN7&8 of CN12 well-connected
Automatically shut down under suitable AC input	Battery discharging peak power over time (Red LED flashes at 4 pulses)	Check load condition and re-power on.
	Over temperature (Red LED flashes at 6 pulses)	Cool down temperature and re-power on.
	Over voltage (Red LED flashes at 2 pulses)	Check specification of battery
	Short circuit (Red LED flashes at 5 pulses)	Eliminate abnormal condition and re-power on.
Battery can not be fully charged	Aged battery or malfunction	Change new batteries
	Small cross-section of cable	Choose a proper cable for usage
	Wrong charging curve	Double check the characteristic of battery

Note : 1. Refer to chapter 4.3 for LED indicator.

2. Please contact MEAN WELL's distributor if above faulty condition is not removable.

7.Warranty

This product provides three years warranty under normal usage. Do not replace parts or any form of modification to the product in order to keep the warranty effectively.

※ MEAN WELL possess the right to adjust the content of this manual. Please refer to the latest version of our manual on our website.
<https://www.meanwell.com>



DRS系列為明緯新推出的導軌式多合一數位智能安防電源。最大特色是運用全數位化智能芯片設計，在緊湊尺寸下 DC電壓供電、電池充電、DC-UPS、通訊監控複合功能一體，其它特點有：90Vac~305Vac輸入通用全球各地、設計符合國際安控消防法規、可通過內建的C型繼電器觸點及LED燈示提供交流電網/電池電壓過低/充電迴路異常等告警信號、優先供電給負載之智慧判斷機制（餘電對電池充電）、可搭配明緯SBP-001編程器連接電腦彈性調整充電參數，或通過面板上DIP S.W切換2段/3段充電及Adj可調20%~100%充電電流、適搭各種不同大小容量的鉛酸或鋰電池、內建Modbus通訊界面可達到遠距離監控功能等。是一款市面上少見的導軌式小型化複合功能智能安防電源供應器。可提供智慧城市、樓宇安全監控最佳電源解決方案。

目錄：

1. 操作安全注意事項	1	5.9 過功率模式	54
2. 產品介紹	2	5.10 恢復出廠設置	55
2.1 機型命名	2	6. 保護功能及異常排除	56
2.2 產品特點	2	6.1 保護功能	56
2.3 電氣規格表	3	6.2 異常排除	57
2.4 安裝一覽表	5	7. 保固	58
2.5 減額曲線	5		
2.6 產品機構圖	6		
3. 安裝說明	8		
3.1 安裝方式	8		
3.2 安裝步驟	9		
3.3 配線選用	9		
3.4 電池類型與容量建議	10		
3.5 電池串聯與並聯使用說明	10		
4. 面板與燈號顯示	11		
4.1 面板功能說明	11		
4.2 功能腳位說明	12		
4.3 LED燈號	13		
5. 功能說明	14		
5.1 DC電壓供電	14		
5.2 DC-UPS功能	14		
5.3 電池充電功能	15		
5.4 通訊監控功能	19		
5.5 警報信號	50		
5.6 電池啟動功能	51		
5.7 強制啟動功能	52		
5.8 溫度補償功能	52		

1. 操作安全注意事項

- 本產品內含高壓線路具潛在危險性，需由專業人員進行安裝，如有異常或無法正常使用，請勿自行拆解或變更產品上任何零件。
- 需放置於通風良好，乾燥之場合，不可暴露在雨中或雪中。
- 本產品不適合在兒童可能會出現場所使用。
- 連接或拔除連接線時，必須確認本產品是處於關閉狀態。
- 電池保護接地導體要連接到設施保護接地導體（例如：用電源軟線連接到具有接地連接插座）。
- 與電池搭配應用注意事項：
 - a. 使用前請先確認充電電壓和充電電流設定符合電池要求。
 - b. 電池串聯充電時，新舊電池不可混合做串聯使用。
 - c. 電池連接至本產品，線長盡可能短（建議約50cm~100cm），避免線壓降過大，拉長電池充飽時間。
 - d. 適用於鉛酸電池（加水式、膠體式、吸附玻璃纖維式等）或鋰電池（鋰鐵、鋰錳、鋰三元等）。
- 僅限室內使用。 

2. 產品介紹

2.1 機型命名

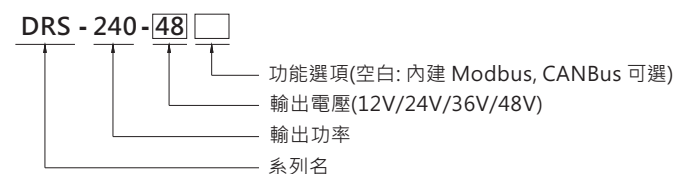

2.2 產品特點

- 多功能一體機（DC供電+電池充電+DC-UPS+通訊監控介面）
- 全範圍90Vac~305Vac輸入並內建PFC（通用北美277Vac）
- 信號和警報設計符合UL2524/EN54-4/GB17945要求
- 優先供電給負載，確保設備可正常運行（餘電給電池充電）
- 採用Form C繼電器
- 內建AC Fail、DC OK、電池電壓過低警示、充電迴路異常偵測
- 支援Modbus通訊（CANBus可選）
- 完整保護功能：短路/過電壓/過載/過溫度/電池反極性（本產品不會損壞）/電池低電壓自動斷開
- 智能化調節充電參數（搭配編程器SBP-001）
- 可調20%~100%額定充電電流
- 可切換2/3段式充電曲線
- 適用於鉛酸電池（加水式、膠體式、吸附玻璃纖維式等）或鋰電池（鋰鐵、鋰錳、鋰三元等）
- 可在-30°C~+70°C寬環溫操作
- LED燈：狀態/異常顯示
- 通過DEKRA/UL/CE/UKCA國際認證（EAC申請中）
- 3年長效保固

2.3 電氣規格表

DRS-240系列

MODEL	DRS-240-12	DRS-240-24	DRS-240-36	DRS-240-48	
OUTPUT	OUTPUT VOLTAGE <small>Note.2</small>	12V	24V	36V	48V
	CURRENT RANGE	0 ~ 20A	0 ~ 10A	0 ~ 6.6A	0 ~ 5A
	BATTERY CURRENT (CC)(max.)	15.4A	7.7A	5.1A	3.85A
	RECOMMENDED BATTERY CAPACITY(AMP HOURS) <small>Note.3</small>	20 ~ 200AH	10 ~ 100AH	6.6 ~ 66AH	5 ~ 50AH
	TOTAL OUTPUT POWER <small>Note.4</small>	Combined power on all Channels must not exceed 240W, load has priority. 275W peak capability within 5s.			
	RIPPLE & NOISE (max.) <small>Note.5</small>	150mVp-p	240mVp-p	360mVp-p	480mVp-p
	VOLTAGE TOLERANCE <small>Note.6</small>	±1.0%	±1.0%	±1.0%	±1.0%
	LINE REGULATION	±0.5%	±0.5%	±0.5%	±0.5%
	LOAD REGULATION	±0.5%	±0.5%	±0.5%	±0.5%
	SETUP, RISE TIME <small>Note.7</small>	2400ms, 1000ms/230VAC 2400ms, 1000ms/115VAC at full load			
HOLD UP TIME (Typ.)	16ms/230VAC 10ms/115VAC at full load				
INPUT	VOLTAGE RANGE	90 ~ 305VAC 127 ~ 431VDC			
	FREQUENCY RANGE	47 ~ 63Hz			
	POWER FACTOR (Typ.)	PF>0.95/230VAC PF>0.98/115VAC at full load			
	EFFICIENCY (Typ.)	90%	92%	92%	92%
	AC CURRENT (Typ.)	2.8A/115VAC 1.4A/230VAC			
	INRUSH CURRENT (Typ.)	COLD START 30A/115VAC 60A/230VAC			
PROTECTION	SHORT CIRCUIT	Protection type: Constant current limiting, power will shutdown after 5 sec, re-power on to recover.			
	OVERLOAD	105 ~ 135% rated output power Protection type: Constant current limiting, shutdown output voltage after 5 sec.			
	OVER TEMPERATURE	Automatically drop load with temperature only for bat. load. Protection type: Shut down o/p voltage, recover automatically after temperature goes down.			
	OVER VOLTAGE	Load main output: 16.2 ~ 18.6V Load main output: 32.4 ~ 37.3V Load main output: 48.6 ~ 55.9V Load main output: 64.8 ~ 74.5V Protection type: Shut down o/p voltage, re-power on to recover			
	BATTERY CUT OFF	10.5 ± 0.3V	20.9 ± 0.5V	31.3 ± 0.7V	41.8 ± 1V
	REVERSE POLARITY	By internal MOSFET, no damage, recovers automatically after fault condition is removed.			
	FUNCTION	FORM-C RELAY	AC FAIL	Signals AC failure and activates when input voltage drops below : 79~89VAC of 120AC, 132~187VAC of 220VAC. Relay contact output, ON : AC OK ; OFF : AC Fail ; max. rating : 30Vdc/1A	
CHARGER FAIL			Relay contact output, ON : Charger OK ; OFF : Charger Fail ; max. rating : 30Vdc/1A		
DC OK			Signals normal DC output and activates when output voltage > 90% rated value. Relay contact output, ON : DC OK ; OFF : DC Fail ; max. rating : 30Vdc/1A		
BATTERY LOW/ABNORMAL/DISCONNECTED			Relay contact output, ON : Battery OK ; OFF : Battery Low ; max. rating : 30Vdc/1A Battery low voltage: < 11 ± 0.2V Battery low voltage: < 22 ± 0.3V Battery low voltage: < 33 ± 0.4V Battery low voltage: < 44 ± 0.5V		
BATTERY START		Restart system directly from battery and does not require AC power			
DC-UPS		UPS switch to battery power within 10ms of AC failure			
ADJUSTABLE CHARGING CURRENT		20% ~ 100% charging current adjustable by VR			
ENVIRONMENT		WORKING TEMP.	-30 ~ +70°C (Refer to "Derating Curve")		
	WORKING HUMIDITY	20 ~ 90% RH non-condensing			
	STORAGE TEMP., HUMIDITY	-40 ~ +85°C, 10 ~ 95% RH non-condensing			
	TEMP. COEFFICIENT	±0.03%/°C (0 ~ 50°C) on Load output			
	VIBRATION	10 ~ 500Hz, 5G 10min./1cycle, 60min. each along X, Y, Z axes			
	OPERATING ALTITUDE <small>Note.8</small>	2000 meters / OVC III			
OTHERS	OVER VOLTAGE CATEGORY	III ; According to Dekra BS EN/EN62368-1; altitude up to 2000 meters			
	MTBF	564.7K hrs min. Telcordia SR-332 (Bellcore); 73.3K hrs min. MIL-HDBK-217F (25°C)			
OTHERS	DIMENSION	85.5*125.2*129.2mm (W*H*D)			
	PACKING	1.19Kg; 8pcs/ 12.5Kg / 1.08CUFT			

DRS-480系列

MODEL	DRS-480-24	DRS-480-36	DRS-480-48	
OUTPUT	OUTPUT VOLTAGE <small>Note.2</small>	24V	36V	48V
	LOAD CURRENT RANGE	0 ~ 20A	0 ~ 13.3A	0 ~ 10A
	BATTERY CURRENT (CC)(max.)	15.4A	10.2A	7.7A
	RECOMMENDED BATTERY CAPACITY(AMP HOURS) <small>Note.3</small>	20 ~ 200AH	13 ~ 133AH	10 ~ 100AH
	TOTAL OUTPUT POWER <small>Note.4</small>	Combined power on all Channels must not exceed 480W, load has priority. 550W peak capability within 5s.		
	RIPPLE & NOISE (max.) <small>Note.5</small>	240mVp-p	360mVp-p	480mVp-p
	VOLTAGE TOLERANCE <small>Note.6</small>	±1.0%	±1.0%	±1.0%
	LINE REGULATION	±0.5%	±0.5%	±0.5%
	LOAD REGULATION	±0.5%	±0.5%	±0.5%
	SETUP, RISE TIME <small>Note.7</small>	2400ms, 1000ms/230VAC 2400ms, 1000ms/115VAC at full load		
HOLD UP TIME (Typ.)	16ms/230VAC 10ms/115VAC at full load			
INPUT	VOLTAGE RANGE	90 ~ 305VAC 127 ~ 431VDC		
	FREQUENCY RANGE	47 ~ 63Hz		
	POWER FACTOR (Typ.)	PF>0.95/230VAC PF>0.98/115VAC at full load		
	EFFICIENCY (Typ.)	92.5%	93.5%	93.5%
	AC CURRENT (Typ.)	5.4A/115VAC 2.7A/230VAC		
	INRUSH CURRENT (Typ.)	COLD START 30A/115VAC 60A/230VAC		
PROTECTION	SHORT CIRCUIT	Protection type: Constant current limiting, power will shutdown after 5 sec, re-power on to recover.		
	OVERLOAD	105 ~ 135% rated output power Protection type: Constant current limiting, shutdown output voltage after 5 sec.		
	OVER TEMPERATURE	Automatically drop load with temperature only for bat. load. Protection type: Shut down o/p voltage, recover automatically after temperature goes down.		
	OVER VOLTAGE	Load main output: 32.4 ~ 37.3V Load main output: 48.6 ~ 55.9V Load main output: 64.8 ~ 74.5V Protection type: Shut down o/p voltage, re-power on to recover		
	BATTERY CUT OFF	20.9 ± 0.5V	31.3 ± 0.7V	41.8 ± 1V
	REVERSE POLARITY	By internal MOSFET, no damage, recovers automatically after fault condition is removed.		
	FUNCTION	FORM-C RELAY	AC FAIL	Signals AC failure and activates when input voltage drops below : 79~89VAC of 120AC, 132~187VAC of 220VAC. Relay contact output, ON : AC OK ; OFF : AC Fail ; max. rating : 30Vdc/1A
CHARGER FAIL			Relay contact output, ON : Charger OK ; OFF : Charger Fail ; max. rating : 30Vdc/1A	
DC OK			Signals normal DC output and activates when output voltage > 90% rated value. Relay contact output, ON : DC OK ; OFF : DC Fail ; max. rating : 30Vdc/1A	
BATTERY LOW/ABNORMAL/DISCONNECTED			Relay contact output, ON : Battery OK ; OFF : Battery Low ; max. rating : 30Vdc/1A Battery low voltage : < 22V ± 0.3V Battery low voltage : < 33V ± 0.4V Battery low voltage : < 44V ± 0.5V	
BATTERY START		Restart system directly from battery and does not require AC power		
DC-UPS		UPS switch to battery power within 10ms of AC failure		
ADJUSTABLE CHARGING CURRENT		20% ~ 100% charging current adjustable by VR		
ENVIRONMENT		WORKING TEMP.	-30 ~ +70°C (Refer to "Derating Curve")	
	WORKING HUMIDITY	20 ~ 90% RH non-condensing		
	STORAGE TEMP., HUMIDITY	-40 ~ +85°C, 10 ~ 95% RH non-condensing		
	TEMP. COEFFICIENT	±0.03%/°C (0 ~ 50°C) on Load output		
	VIBRATION	10 ~ 500Hz, 5G 10min./1cycle, 60min. each along X, Y, Z axes		
	OPERATING ALTITUDE <small>Note.8</small>	2000 meters / OVC III		
OTHERS	OVER VOLTAGE CATEGORY	III ; According to Dekra BS EN/EN62368-1; altitude up to 2000 meters		
	MTBF	556.6K hrs min. Telcordia SR-332 (Bellcore); 74.5K hrs min. MIL-HDBK-217F (25°C)		
OTHERS	DIMENSION	110*125.2*150.7mm (W*H*D)		
	PACKING	1.65Kg; 6pcs/ 11Kg / 1.42CUFT		

2.4 安規一覽表



2.5 減額曲線

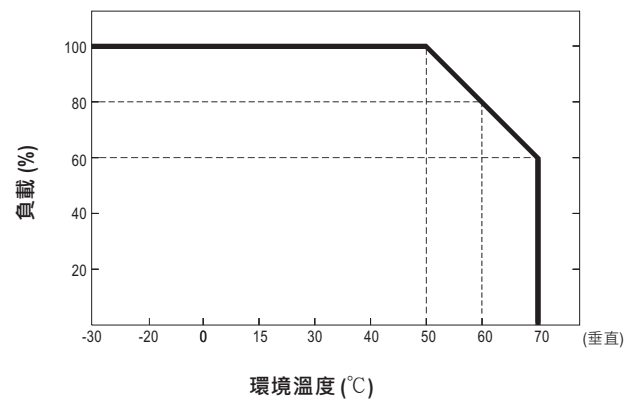

2.6 產品機構圖

(DRS-240系列)

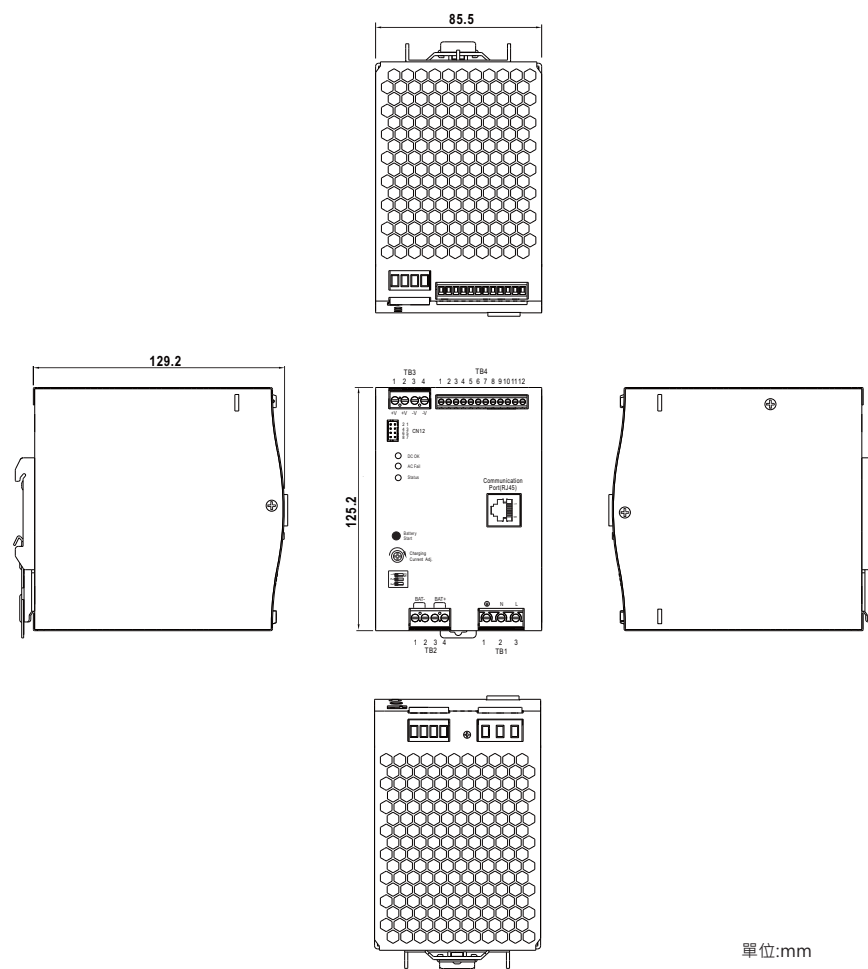

(DRS-480系列)

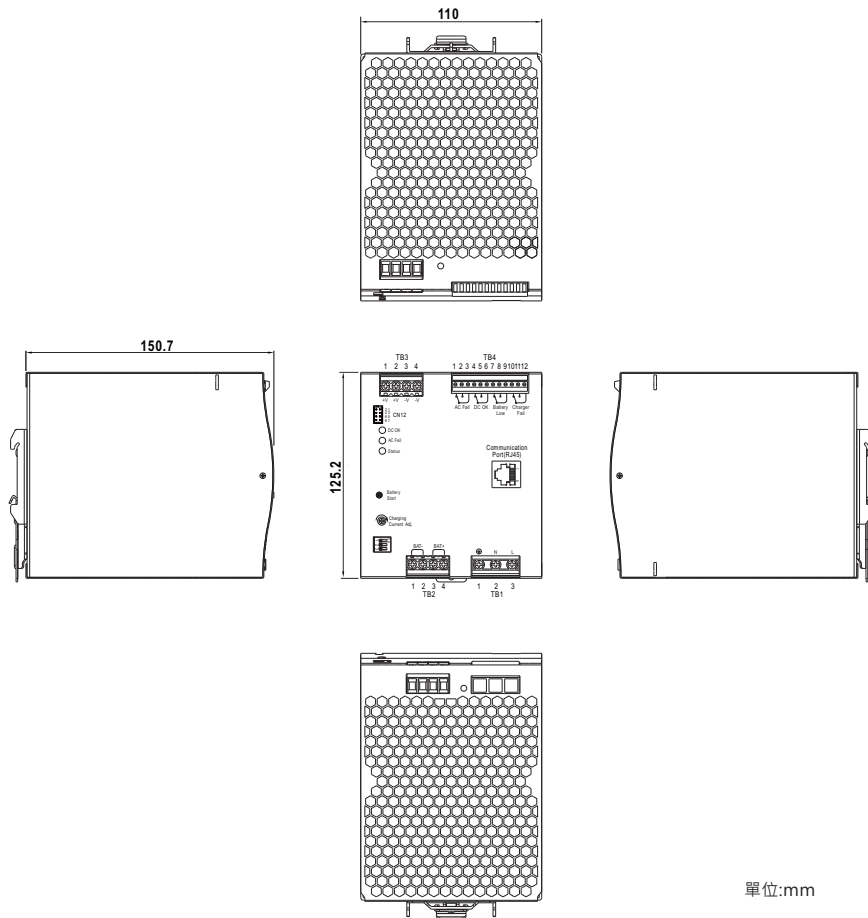

單位:mm

3. 安裝說明

3.1 安裝方式

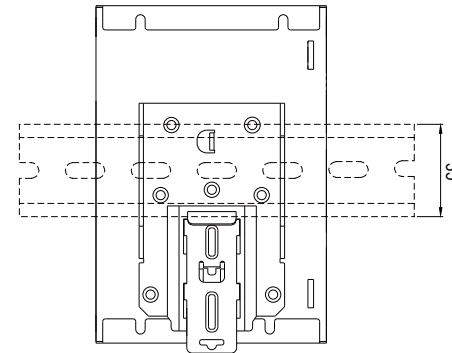

可安裝 DIN導軌:TS35/7.5或TS35/15
(僅供參考·不包含在電源中)

- ① 稍微向後傾斜裝置
- ② 從上方適當地用力壓入導軌
- ③ 把它向下滑動·直到它停下來
- ④ 向底部推壓以鎖緊
- ⑤ 輕輕搖動以檢查鎖緊

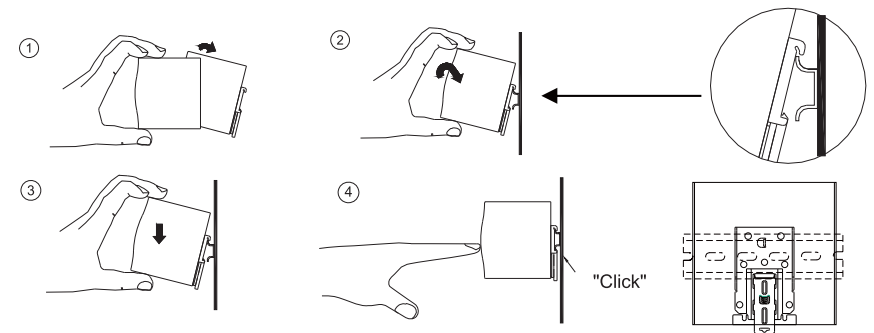

3.2 安裝步驟

步驟1. 請先將AC線材、DC負載線材、電池連接線材、RJ-45通訊線材 (若有使用才接) 連接本產品面板上 對應端子台。



步驟2. 確認配線皆正確接好後，啟動AC電網開關將本產品通電開機。
 步驟3. 通電開機後，確認LED燈顯示為綠燈或橘燈即為正常工作 (LED燈狀態請參考4.3章節)。

3.3 配線選用

配線建議越短越好，且線徑選用需根據安規規定選取可承載電流量之導線。配線過細將會造成電源效率偏低或無法正常滿功率輸出，並且將造成線材過熱發生著火危險。請參照下表。

AWG	截面積(mm ²)	最大耐流量(A)UL1015(600V 105°C)
18	0.8	6
16	1.3	8
14	2.1	12
12	3.3	22
10	5.3	35
7	10	46
6	16	60
4	25	80
2	43	110

線材使用建議表

3.4 電池類型與容量建議

電池種類: 適用鉛酸電池或鋰電池，建議容量請參考下表：

型號	建議電池容量			
	12V	24V	36V	48V
DRS-240	20~200AH 或以上	10~ 100AH 或以上	6.6~66AH 或以上	5~ 50AH 或以上
DRS-480	/	20~200AH 或以上	13~ 133AH 或以上	10~100AH 或以上

NOTE:

1. 電池容量大於建議值並不會損壞電池，只是電池充飽時間變長。
2. 充電前請確認充電壓與電流是否符合電池規格。若您對電池可容許之充電電壓/電流有所疑問，請參考電池廠商所提供之技術資料或詢問電池廠商。

3.5 電池串聯與並聯使用說明

- 電池串聯: 連接2顆電池串聯則電壓變為2倍，但AH容量維持不變，例如12V 100AH 串聯2顆=24V 100AH

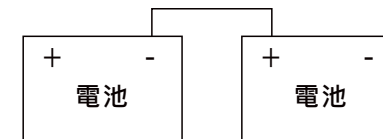

- 電池並聯: 連接2顆電池並聯則電壓維持不變，但AH容量則變為2倍，例如12V 100AH 並聯2顆=12V 200AH

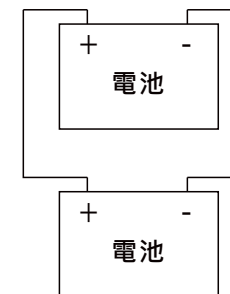

4. 面板與燈號顯示

4.1 面板功能說明

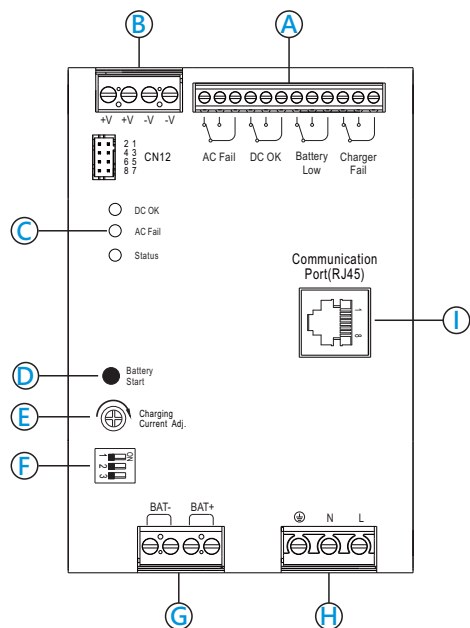

- A** 訊號功能接點
用於電源狀態檢測等用途，請參考4.2功能腳位說明
- B** DC輸出端子接點
- C** LED狀態指示燈
顯示電源 工作狀態及充電情況
- D** 電池啟動按鈕
系統可通過電池重新啟動，無需交流輸入
- E** Io Adj.
用於調整充電電流設定（依電池容量大小可彈性調節）
- F** 充電曲線設定

1	OFF:3段（出廠設置），ON:2段
2	充電曲線調整
3	

 充電曲線調整參數請參考5.3.4.1章節
- G** 連接電池接點
- H** 連接AC輸入接點
- I** 用於Modbus通訊

端子台配線選用和鎖線建議使用扭力：

端子位置 系列	輸入端 (G)		輸出端 (A)		電池充/放電端 (F)		功能連接端 (C)	
	建議線徑	建議扭力	建議線徑	建議扭力	建議線徑	建議扭力	建議線徑	建議扭力
DRS-240	12-26AWG	5Kgf-cm	12-24AWG	5.7Kgf-cm	12-24AWG	5.7Kgf-cm	14-30AWG	2Kgf-cm
DRS-480	10-22AWG	10Kgf-cm	10-22AWG	8Kgf-cm	10-22AWG	8Kgf-cm	16-26AWG	2Kgf-cm

4.2 功能腳位說明

端子PIN腳編號 (CN12) : JS-2008R-4*2-T或同等級

Pin腳編號	功能	功能說明	連接器
1	3.3V	+3.3V編輯器使用	
2	GND	通訊介面定址用之參考地	
3	RTH+	連接傳感器NTC線	
4	RTH-		
5	A0	通訊介面定址用(A1)·參考地為PIN2GND(Signal)	
6	A1	通訊介面定址用(A0)·參考地為PIN2GND(Signal)	
7,8	強制啟動 電池供電	短接一下即可強制啟動電池供電	

端子Pin腳編號 (TB4)

Pin腳編號	功能	功能說明	端子
1,2,3	AC fail	參考5.5.1電源的警報功能	
4,5,6	DC OK	參考5.5.2電源的警報功能	
7,8,9	Battery low/ Abnormal/ Disconnected	參考5.5.3電源的警報功能	
10,11,12	Charger fail	參考5.5.4電源的警報功能	

端子Pin腳編號 (RJ-45)

Pin腳編號	功能	功能說明	端子
1,2,3,4,5	NC	供將來使用	
6	Data+	Modbus模式: 串行數據用於Modbus 接口	
	CANH	CANBus模式: 數據線用於CANBus 接口	
7	Data-	Modbus模式: 串行數據用於Modbus 接口	
	CANL	CANBus模式: 數據線用於 CANBus 接口	
8	GND-AUX	輔助電壓輸出 GND·該信號迴路與主輸出(+V & -V)是隔離的	

4.3 LED燈號

功能	描述	輸出警報	
DC OK	DC fail	熄滅 ○	
	DC OK	綠色 ●	
AC fail	AC fail	紅色 ●	
	AC OK	熄滅 ○	
狀態	充電狀態	浮充	綠色 ●
		充電: CC/CV	橙色 ●
	系統診斷	放電	橙色:1個脈衝/暫停 
		充電失敗	紅色:1個脈衝/暫停 
		電池過壓/電池反極性	紅色:2個脈衝/暫停 
		電池電量不足/無電池	紅色:3個脈衝/暫停 
		電池放電峰值功率超時	紅色:4個脈衝/暫停 
		過載/短路	紅色:5個脈衝/暫停 
		過溫	紅色:6個脈衝/暫停 
		超時	紅色:7個脈衝/暫停 

5. 功能說明

DRS系列是緊湊尺寸下具備了多項功能，包含DC電壓供電給負載、可對電池充電、DC-UPS 備援、通訊監控介面等4大主功能，並有警報信號(AC Fail、DC OK、電池電量過低/未接好、充電迴路異常)、可調2段或3段電池充電、可調額定充電電流 20%~100%、溫度補償...等附屬功能。

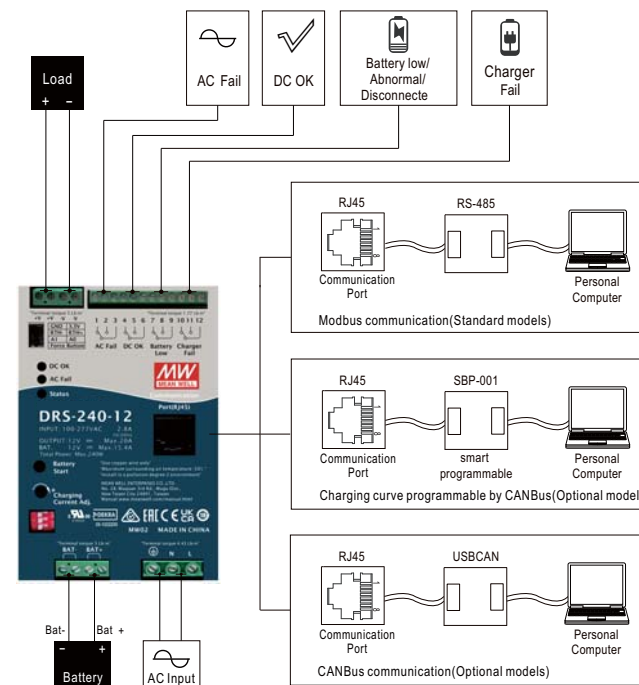

5.1 DC電壓供電

電源接入AC電網，提供DC電壓，優先給負載供電，餘電給電池充電。自動減小充電電流保證系統供電的穩定性。

5.2 DC-UPS 功能

5.2.1. 當交流輸入電壓由120Vac降至79Vac~89Vac或由220Vac降至132Vac~187Vac，產品偵測到AC電網異常時會啟動UPS功能，由電池供電備援。

註：由AC電網切換為電池供電，切換時間為10ms max.

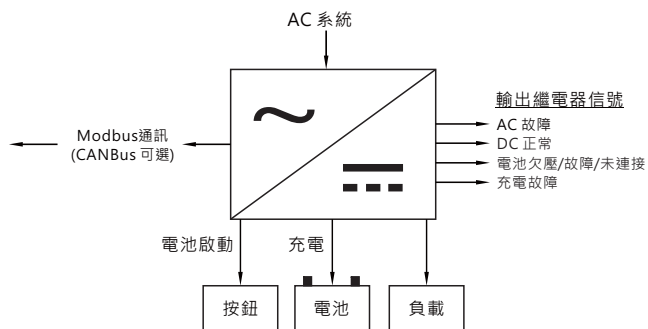

5.2.2. 備用時間

備用時間取決於：

※負載電流

※電池尺寸

舉例如下(C10放電時的電池容量)

Battery Load	10AH	20AH	50AH	100AH	200AH
1.5A	350min	13h	33h	67h	133h
3A	125min	350min	17h	33h	67h
5A	60min	180min	600min	20h	40h
7.5A	35min	90min	350min	13h	27h
10A	23min	60min	240min	10h	20h
15A	13min	35min	125min	350min	13h

5.3 電池充電功能

DRS面板上 DIP開關可彈性切換2/3段充電，2段 (C.C+C.V) 充電是簡易快速充電模式，3段 (C.C+C.V+F.V) 相同於2段而電池充飽後不關機，使用者可依電池種類來選擇充電模式。

註：AC開機5s內，電池預設為斷開狀態，5s後電池接入。

5.3.1 2段式充電 (DIP開關切至 "2" stage)



於充電初期，充電器以最大電流對電池充電，經過一段時間後(視電池容量而定)，充電電流逐漸下降，當充電電流下降至最大電流之10%左右時，LED指示燈亮綠燈，表示充電完成，充電結束後關閉電池端輸出；負載端持續輸出。

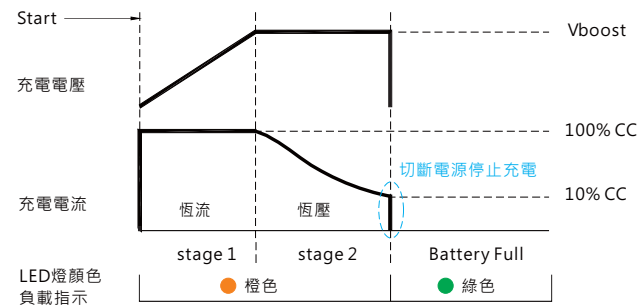

狀態	DRS-240-12	DRS-240-24	DRS-240-36	DRS-240-48
恆流	15.4A	7.7A	5.1A	3.85A
Vboost	14.4V	28.8V	43.2V	57.6V

狀態	DRS-480-24	DRS-480-36	DRS-480-48
恆流	15.4A	10.2A	7.7A
Vboost	28.8V	43.2V	57.6V

5.3.2 3段式充電 (DIP開關切至 "3" stage)



於充電初期，充電器以最大電流對電池充電，經過一段時間後(視電池容量而定)，充電電流逐漸下降，當充電電壓下降至最大電流 10%左右時，LED指示燈亮綠燈，表示充電完成並維持浮充狀態。

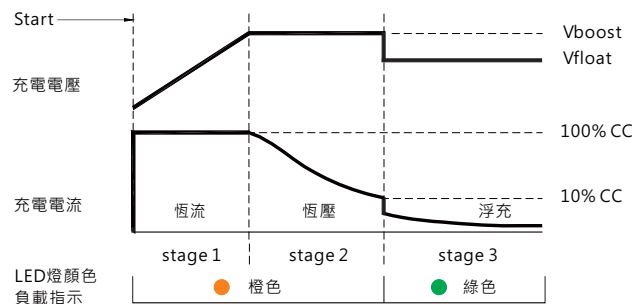

狀態	DRS-240-12	DRS-240-24	DRS-240-36	DRS-240-48
恆流	15.4A	7.7A	5.1A	3.85A
Vboost	14.4V	28.8V	43.2V	57.6V
Vfloat	13.8V	27.6V	41.4V	55.2V

狀態	DRS-480-24	DRS-480-36	DRS-480-48
恆流	15.4A	10.2A	7.7A
Vboost	28.8V	43.2V	57.6V
Vfloat	27.6V	41.4V	55.2V

5.3.3 最大充電電流可調

可通過面板上的SVR調節20%~100%最大充電電流。



5.3.4 充電曲線設定

5.3.4.1 通過DIP開關設定

出廠設定為**default**曲線，若需變更充電參數，可通過DIP開關切換位置變曲線，對應曲線及電壓範圍如下。

1	OFF:3段 (出廠設置), ON:2段	
2	充電曲線可調，見下圖	
3		

內置2段式充電曲線規格

DRS-240

DIP SW 位置		12V model		
2	3	描述	CC(默認)	Vboost
OFF	OFF	默認,可編程	15.4A	14.4
ON	OFF	預定義, Gel電池		14.0
OFF	ON	預定義, 富液態式電池		14.2
ON	ON	預定義, AGM、鋰鐵電池		14.6
DIP SW 位置		24V model		
2	3	描述	CC(默認)	Vboost
OFF	OFF	默認,可編程	7.7A	28.8
ON	OFF	預定義, Gel電池		28.0
OFF	ON	預定義, 富液態式電池		28.4
ON	ON	預定義, AGM、鋰鐵電池		29.2
DIP SW 位置		36V model		
2	3	描述	CC(默認)	Vboost
OFF	OFF	默認,可編程	5.1A	43.2
ON	OFF	預定義, Gel電池		42
OFF	ON	預定義, 富液態式電池		42.6
ON	ON	預定義, AGM、鋰鐵電池		43.8
DIP SW 位置		48V model		
2	3	描述	CC(默認)	Vboost
OFF	OFF	默認,可編程	3.85A	57.6
ON	OFF	預定義, Gel電池		56.0
OFF	ON	預定義, 富液態式電池		56.8
ON	ON	預定義, AGM、鋰鐵電池		58.4

DRS-480

DIP SW 位置		24V model		
2	3	描述	CC(默認)	Vboost
OFF	OFF	默認,可編程	15.4A	28.8
ON	OFF	預定義, Gel電池		28.0
OFF	ON	預定義, 富液態式電池		28.4
ON	ON	預定義, AGM、鋰鐵電池		29.2
DIP SW 位置		36V model		
2	3	描述	CC(默認)	Vboost
OFF	OFF	默認,可編程	10.2A	43.2
ON	OFF	預定義, Gel電池		42
OFF	ON	預定義, 富液態式電池		42.6
ON	ON	預定義, AGM、鋰鐵電池		43.8
DIP SW 位置		48V model		
2	3	描述	CC(默認)	Vboost
OFF	OFF	默認,可編程	7.7A	57.6
ON	OFF	預定義, Gel電池		56.0
OFF	ON	預定義, 富液態式電池		56.8
ON	ON	預定義, AGM、鋰鐵電池		58.4

NOTE:電壓誤差±2%

內置3段式充電曲線規格

DRS-240

DIP SW 位置		12V model			
2	3	描述	CC(默認)	Vboost	Vfloat
OFF	OFF	默認,可編程	15.4A	14.4	13.8
ON	OFF	預定義, Gel電池		14.0	13.6
OFF	ON	預定義, 富液態式電池		14.2	13.4
ON	ON	預定義, AGM、鋰鐵電池		14.6	14.0
DIP SW 位置		24V model			
2	3	描述	CC(默認)	Vboost	Vfloat
OFF	OFF	默認,可編程	7.7A	28.8	27.6
ON	OFF	預定義, Gel電池		28.0	27.2
OFF	ON	預定義, 富液態式電池		28.4	26.8
ON	ON	預定義, AGM、鋰鐵電池		29.2	28.0
DIP SW 位置		36V model			
2	3	描述	CC(默認)	Vboost	Vfloat
OFF	OFF	默認,可編程	5.1A	43.2	41.4
ON	OFF	預定義, Gel電池		42	40.8
OFF	ON	預定義, 富液態式電池		42.6	40.2
ON	ON	預定義, AGM、鋰鐵電池		43.8	42.0
DIP SW 位置		48V model			
2	3	描述	CC(默認)	Vboost	Vfloat
OFF	OFF	默認,可編程	3.85A	57.6	55.2
ON	OFF	預定義, Gel電池		56.0	54.4
OFF	ON	預定義, 富液態式電池		56.8	53.6
ON	ON	預定義, AGM、鋰鐵電池		58.4	56.0

DRS-480

DIP SW 位置		24V model			
2	3	描述	CC(默認)	Vboost	Vfloat
OFF	OFF	默認,可編程	15.4A	28.8	27.6
ON	OFF	預定義, Gel電池		28.0	27.2
OFF	ON	預定義, 富液態式電池		28.4	26.8
ON	ON	預定義, AGM、鋰鐵電池		29.2	28.0
DIP SW 位置		36V model			
2	3	描述	CC(默認)	Vboost	Vfloat
OFF	OFF	默認,可編程	10.2A	43.2	41.4
ON	OFF	預定義, Gel電池		42	40.8
OFF	ON	預定義, 富液態式電池		42.6	40.2
ON	ON	預定義, AGM、鋰鐵電池		43.8	42.0
DIP SW 位置		48V model			
2	3	描述	CC(默認)	Vboost	Vfloat
OFF	OFF	默認,可編程	7.7A	57.6	55.2
ON	OFF	預定義, Gel電池		56.0	54.4
OFF	ON	預定義, 富液態式電池		56.8	53.6
ON	ON	預定義, AGM、鋰鐵電池		58.4	56.0

NOTE:電壓誤差±2%

5.3.4.2 通過通訊設定

使用者可通過Modbus或CANBus (可選) 通訊設定充電相關參數，包含定電流、定電壓、浮充電壓、轉態電流、溫度補償及充電計時等。詳細細節請參考5.4 通訊監控功能。

5.3.4.3 通過智能充電編程器SBP-001 (僅支援CANBus版本) 設定

SBP-001為明緯自行開發之智能電池充電編程器，可搭接電腦彈性設定DRS系列之充電曲線。SBP-001提供的功能有充電曲線調整、電池溫度補償等。

使用時請先將DIP開關腳位設定為Default，programmable(PIN2:OFF, PIN3:OFF)。安裝配置及軟體介面如下。詳細使用說明請參考「SBP-001智能化可編程電池充電器編輯軟體使用手冊」。

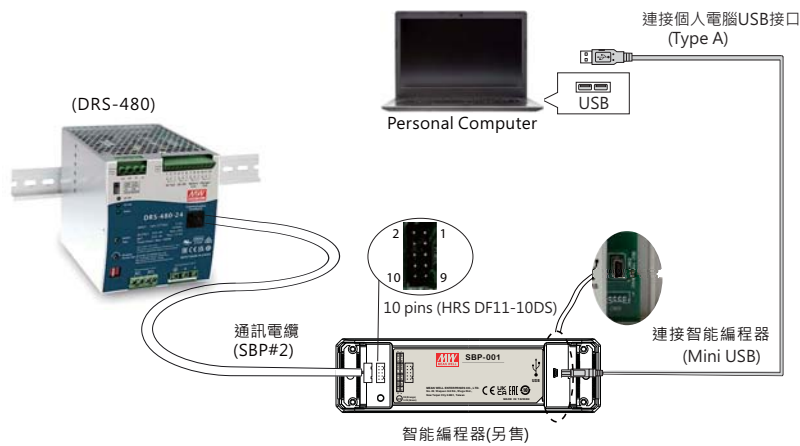

5.4 通訊監控協定

5.4.1 Modbus通訊

Modbus通訊可讀取並控制Power Supply、Charger (Slave) 之設定與狀態資訊參數，包含開/關機、輸出電壓和電流、溫度等。中Charger還可讀取及設定充電曲線參數，包含定電流、定電壓、浮充電壓、轉態電流、溫度補償及充電計時等。

5.4.1.1 Modbus相關規格

Modbus匯流排通訊界面

本裝置採用Modbus RTU主/從傳輸模式。除Error Check(CRC-16)資料外，所有 word資料必須符合High byte先傳送之原則。

通訊實體層設置如下：

Control	Setting
波特率	115200
數據位	8
停止位	1
校驗位	None
串口流控制	None

5.4.1.2 通訊時序

最小請求週期 (Controller to PSU/CHG): 20mSec。

最大響應時間 (PSU/CHG to Controller): 5mSec。

最小數據包間隔時間 (Controller to PSU/CHG): 5mSec。

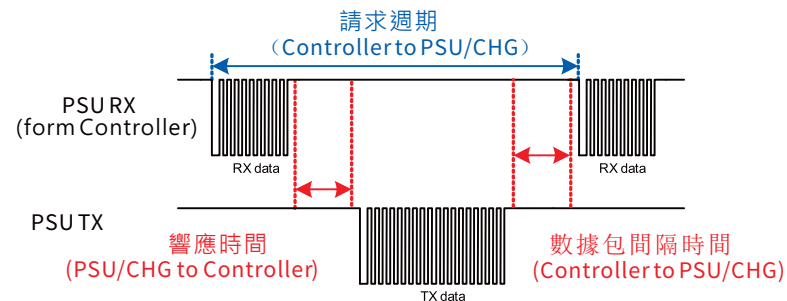

5.4.1.3 Modbus通訊協定基本封包架構

Modbus RTU訊息由Additional Address、Function Code、Data及Error Check組成

Additional address	Function code	Data	Error check
1 byte	1 byte	N bytes	2 bytes

Additional address (1byte) : 有效之PSU address ID。

Function code (1byte) : 資料讀取或寫入控制命令代碼。

Data (N bytes):資料交換訊息結構，資料長度及內容視控制命令代碼定。

Error Check (2bytes) : 使用CRC-16。

5.4.1.4 Additional Address 定義

Additional Address為PSU/Charger之Slave ID。使用Modbus通訊時，
 每台電源需設定唯一且不重複之設備位址，由CN12之A0~A1設置。
 設備位址設定如下：

A0/A1與GND (Single) 之間	logic	Device No.	Device address	
開路	1		A1	A0
短路	0	0	0	0
		1	0	1
		2	1	0
		3	1	1

Slave ID	敘述
0x8X	X代表該裝置之位元址
0x00	廣播(Broadcast)

Note:廣播(Broadcast)只能進行設定命令，無法進行讀取命令。

5.4.1.5 Function Code說明

Function Code 主要用途是通知Slave設備該執行什麼樣 操作。

例如: 代碼03將會請求Slave設備回傳參數暫存器 狀態值。

DRS所使用Function Code代碼如下：

Function Code		敘述
Read Holding Register	0x03	參數暫存器讀取
Read Input Register	0x04	類比暫存器讀取
Preset Single Register	0x06	單一暫存區寫入

5.4.1.6 Data命令表單

Modbus通訊架構主要以暫存器位址(Register address) 讀寫來達成控制
 /設定及監視功能。

根據不同 Function Code功能請求，Data field可有以下兩種組成。

FC=03/04

Starting Address	Quantity of (Input) Registers
2 Bytes	2 Bytes

FC=06

Register Addressr	Register Value
2 Bytes	2 Bytes

以下為本協定暫存器地址資料說明

暫存器位址	Byte數目	資料名稱	敘述	Function code	數值範圍	單位
0x0000	2	OPERATION	開啟/關閉控制	0x03、0x06	0x00(關閉)/0x01(開啟)	-
0x0020	2	VOUT_SET	輸出電壓設定	0x03、0x06	設定參數5.4.4	V
0x0040	2	FAULT_STATUS	異常狀態	0x03	傳輸資料說明	-
0x0050	2	READ_VIN	單相輸入電壓	0x04	顯示參數5.4.4	V
0x0060	2	READ_VOUT	輸出電壓	0x04	顯示參數5.4.4	V
0x0061	2	READ_IOUT	輸出電流	0x04	顯示參數5.4.4	A
0x0062	2	READ_TEMPERATURE_1	內環境溫度	0x04	顯示參數5.4.4	°C
0x0080~0x0082	6	MFR_ID_B0B5	製造商名稱	0x03	傳輸資料說明	ASCII
0x0083~0x0085	6	MFR_ID_B6B11	製造商名稱	0x03	傳輸資料說明	ASCII
0x0086~0x0088	6	MFR_MODEL_B0B5	製造商機型名稱	0x03	傳輸資料說明	ASCII
0x0089~0x008B	6	MFR_MODEL_B6B11	製造商機型名稱	0x03	傳輸資料說明	ASCII
0x008C~0x008E	6	MFR_REVISION_B0B5	韌體版本	0x03	傳輸資料說明	Binary
0x008F~0x0090	4	MFR_LOCATION_B0B2	製造產地	0x03、0x06	TWN(台灣)/CHN(中國)	ASCII
0x0091~0x0093	6	MFR_DATE_B0B5	製造日期	0x03、0x06	傳輸資料說明	ASCII
0x0094~0x0096	6	MFR_SERIAL_B0B5	製造序號	0x03、0x06	傳輸資料說明	ASCII
0x0097~0x0099	6	MFR_SERIAL_B6B11	製造序號	0x03、0x06	傳輸資料說明	ASCII
0x00B0	2	CURVE_CC	充電曲線定電流 (only for charger)	0x03、0x06	設定參數5.4.4	A
0x00B1	2	CURVE_CV	充電曲線定電壓 (only for charger)	0x03、0x06	設定參數5.4.4	V
0x00B2	2	CURVE_FV	充電曲線浮充電壓 (only for charger)	0x03、0x06	設定參數5.4.4	V

0x00B3	2	CURVE_TC	充電曲線轉態電流 (only for charger)	0x03、 0x06	設定參數5.4.4	A
0x00B4	2	CURVE_CONFIG	充電器功能 (only for charger)	0x03、 0x06	傳輸資料說明	-
0x00B5	2	CURVE_CC_TIMEOUT	充電曲線定電流充電 計時 (only for charger)	0x03、 0x06	設定參數5.4.4	Min
0x00B6	2	CURVE_CV_TIMEOUT	充電曲線定電壓充電 計時	0x03、 0x06	設定參數5.4.4	Min
0x00B7	2	CURVE_FV_TIMEOUT	充電曲線浮充充電計時 (only for charger)	0x03、 0x06	設定參數5.4.4	Min
0x00B8	2	CHG_STATUS	充電器狀態 (only for charger)	0x03	傳輸資料說明	-
0x00C0~ 0x00C2	6	SCALING_FACTOR	比例因子	0x03	傳輸資料說明	-
0x00C3	2	SYSTEM_STATUS	運行狀態	0x03	傳輸資料說明	-
0x00C4	2	SYSTEM_CONFIG	運行模式設定	0x03、 0x06	傳輸資料說明	-
0x00D0	2	BAT_UVP_SET	BAT_LOW 保護點設定	0x03、 0x06	設定參數5.4.4	V
0x00D1	2	Force_BAT_UVP_SET	強制啟動狀態 BAT_LOW 保護點設定	0x03、 0x06	設定參數5.4.4	V
0x00D2	2	UPS_CONFIG	UPS設定模式	0x03、 0x06	傳輸資料說明	-
0x00D3	2	READ_VBAT	電池電壓	0x04	顯示參數5.4.4	V
0x00D4	2	READ_IBAT	電池充放電電流	0x04	顯示參數5.4.4	A
0x00D5	2	READ_BAT_TEMPERATURE	電池溫度	0x04	顯示參數5.4.4	°C
0x00E0	2	AC_Fail_LL_SET	AC Lo_line 應急 轉應急轉換點設定	0x03、 0x06	設定參數5.4.4	V
0x00E1	2	AC_Fail_HL_SET	AC Hi_line 應急 轉應急轉換點設定	0x03、 0x06	設定參數5.4.4	V
0x00E2	2	AC_OK_LL_SET	AC Lo_line 應急 轉主電轉換點設定	0x03、 0x06	設定參數5.4.4	V
0x00E3	2	AC_OK_HL_SET	AC Hi_line 應急 轉主電轉換點設定	0x03、 0x06	設定參數5.4.4	V
0x00E4	2	TIME_BUFFERING	備源時間設定	0x03、 0x06	設定參數5.4.4	Min

傳輸資料說明：

設定、讀取數值換算定義如下：

實際值 = 通訊讀值 × Factor。中Factor需參照各機型清單
SCALING_FACTOR定義。

EX: V_{o_real} (輸出電壓實際值) = $READ_VOUT \times Factor$ 。

若某機型 $READ_VOUT$ Factor為0.01、通訊讀值為0x0960(16進
制)= > 2400(10進制)，則 $V_{o_real} = 2400 \times 0.01 = 24.00V$ 。

◎ FAULT_STATUS(0x0040)定義如下：

	Bit7	Bit6	Bit5	Bit4	Bit3	Bit2	Bit1	Bit0
High byte	Reserved	Reserved	Reserved	Reserved	Reserved	Reserved	Reserved	Reserved
Low byte	HI_TEMP	OP_OFF	AC_FAIL	SHORT	OLP	OVP	OTP	FAN_FAIL

Low byte

Bit 0 FAN_FAIL：風扇異常狀態 (不支援)

0 = 風扇正常

1 = 風扇異常

Bit 1 OTP：過溫度保護狀態

0 = 非處於過溫度保護

1 = 處於過溫度保護

Bit 2 OVP：輸出過電壓保護狀態

0 = 非處於輸出過電壓保護

1 = 處於輸出過電壓保護

Bit 3 OLP：過載保護狀態

0 = 非處於過載保護

1 = 處於過載保護

Bit 4 SHORT：短路保護狀態

0 = 非處於短路保護

1 = 處於短路保護

Bit 5 AC_FAIL：輸入電壓異常保護狀態

0 = 非處於輸入電壓異常保護

1 = 處於輸入電壓異常保護

Bit 6 OP_OFF：輸出關閉指示

0 = 處於輸出開啟

1 = 處於輸出關閉

Bit 7 HI_TEMP : 環溫過高警告
 0 = 處於環溫正常
 1 = 處於環溫過高

High byte:

Bit 0:7 Reserved : 目前未使用 · 保留(default為0)

Note: 不支援顯示 狀態 · 以0做顯示

◎ MFR_ID_B0B5(0x0080-0x0082)為製造商名稱前6碼;

MFR_ID_B6B11(0x0083-0x0085)為製造商名稱後6碼(以 ASCII表示)

EX:製造商為MEANWELL MFR_ID_B0B5為MEANWE; MFR_ID_B6B11為LL

MFR_ID_B0B5					
Byte 0	Byte 1	Byte 2	Byte 3	Byte 4	Byte 5
0x4D	0x45	0x41	0x4E	0x57	0x45

MFR_ID_B6B11					
Byte 0	Byte 1	Byte 2	Byte 3	Byte 4	Byte 5
0x4C	0x4C	0x20	0x20	0x20	0x20

◎ MFR_MODEL_B0B5(0x0086-0x0088)為機型碼前6碼;

MFR_MODEL_B6B11(0x0089-0x008B)為機型碼後6碼(以 ASCII表示)

EX: 機型DRS-480-24 MFR_MODEL_B0B5為DRS-48;
 MFR_MODEL_B6B11為0-24

MFR_MODEL_B0B5					
Byte 0	Byte 1	Byte 2	Byte 3	Byte 4	Byte 5
0x44	0x52	0x53	0x2D	0x34	0x38

MFR_ID_B6B11					
Byte 6	Byte 7	Byte 8	Byte 9	Byte 10	Byte 11
0x30	0x2D	0x32	0x34	0x20	0x20

◎ MFR_REVISION_B0B5(0x008C-0x008E) 最多可表示六個MCU的韌體版本(以Binary表示) · 其中順序依韌體程式料號編碼中的MCU編號 · 一個MCU的韌體版本範圍為0x00(R00.0)~0xFE(R25.4) · 無版本的部分以0xFF表示 ·

EX1: PSU產品有六顆MCU · MCU編號為1的韌體版本為R01.3版(0x0D) · 編號為2 韌體為R01.2版(0x0C) · 編號為3 韌體為R01.1版(0x0B) · 餘的為R01.0版(0x0A)

Byte 0	Byte 1	Byte 2	Byte 3	Byte 4	Byte 5
0x0D	0x0C	0x0B	0x0A	0x0A	0x0A

EX2: PSU產品有三顆MCU · MCU編號為1的韌體版本為R25.4版(0xFE) · 編號為2 韌體為R10.5版(0x69) · 編號為3 韌體為R01.0版(0x0A)

Byte 0	Byte 1	Byte 2	Byte 3	Byte 4	Byte 5
0xFE	0x69	0x0A	0xFF	0xFF	0xFF

◎ MFR_DATE_B0B5(0x0091-0x0093)定義為西元後兩碼加上日期四碼(以 ASCII表示)

EX: 製造日期為2018年1月1號 MFR_DATE_B0B5為180101

Byte 0	Byte 1	Byte 2	Byte 3	Byte 4	Byte 5
0x31	0x38	0x30	0x31	0x30	0x31

◎ MFR_SERIAL_B0B5(0x0094-0x0096) · MFR_SERIAL_B6B11(0x0097-0x0099)定義為製造日期六碼加上製造序號六碼(以ASCII表示)

EX: 2018年1月1號製造 · 序號第一台MFR_SERIAL_B0B5為180101;
 MER_SERIAL_B6B11為000001

Byte 0	Byte 1	Byte 2	Byte 3	Byte 4	Byte 5
0x31	0x38	0x30	0x31	0x30	0x31

Byte 0	Byte 1	Byte 2	Byte 3	Byte 4	Byte 5
0x30	0x30	0x30	0x30	0x30	0x31

◎ CURVE_CONFIG(0x00B4)(only for charger)定義如下:

	Bit7	Bit6	Bit5	Bit4	Bit3	Bit2	Bit1	Bit0
High byte	Reserved	Reserved	Reserved	Reserved	Reserved	FVTOE	CVTOE	CCTOE
Low byte	CUVE	STGS	Reserved	Reserved	TCS		CUVS	

Low byte:

Bit 0:1 CUVS : 充電曲線選擇

00 = 載入客戶燒錄充電曲線(default)

01 = 載入預設充電曲線#1

10 = 載入預設充電曲線#2

11 = 載入預設充電曲線#3

Bit 2:3 TCS : 溫度補償設定

00 = disable

01 = -3 mV/°C/cell (default)

10 = -4 mV/°C/cell

11 = -5 mV/°C/cell

Bit 4:5 Reserved : 目前未使用 · 保留(default為0)

Bit 6 STGS : 2/3段充電設定

0 = 3段充電 (default)

1 = 2段充電

Bit 7 CUVE : 充電曲線致能 (default為1)

0 = 關閉(VI mode)

1 = 開啟(Curve mode)

High byte:

Bit 0 CCTOE : CC timeout致能

0 = 關閉 (default)

1 = 開啟

Bit 1 CVTOE : CV timeout致能

0 = 關閉 (default)

1 = 開啟

Bit 2 FTTOE : Floating timeout致能

0 = 關閉 (default)

1 = 開啟

Bit 3:7 Reserved : 目前未使用 · 保留(default為0)

Note: 不支援 設定 · 以0做顯示

◎ CHG_STATUS(0x00B8)(only for charger)定義如下 :

	Bit7	Bit6	Bit5	Bit4	Bit3	Bit2	Bit1	Bit0
Highbyte	FVTOF	CVTOF	CCTOF	BUFFTOF	BTNC	NTCER	Reserved	Reserved
Lowbyte	DCM	Reserved	Reserved	Reserved	FVM	CVM	CCM	FULLM

Low byte:

Bit 0 FULLM : 充飽電模式狀態

0 = 未充飽電

1 = 充飽電

Bit 1 CCM : 定電流充電模式狀態

0 = 充電器非處於定電流模式

1 = 充電器處於定電流模式

Bit 2 CVM : 定電壓充電模式狀態

0 = 充電器非處於定電壓模式

1 = 充電器處於定電壓模式

Bit 3 FVM : 浮充模式狀態

0 = 充電器非處於浮充模式

1 = 充電器處於浮充模式

Bit 4:6 Reserved : 目前未使用 · 保留(default為0)

Bit 7 DCM : 電池放電模式狀態

0 = 電池處於充電狀態

1 = 電池處於放電狀態

High byte:

Bit 0:1 Reserved : 目前未使用 · 保留(default為0)

Bit 2 NTCER : 溫度補償短路

0 = 溫度補償線路無發生短路

1 = 溫度補償線路發生短路

Bit 3 BTNC : 電池未接

0 = 偵測到電池

1 = 未偵測到電池

Bit 4 BUFFTOF : 備源使用超時旗標

0 = 備源模式電池放電未超時

1 = 備源模式電池放電超時

Bit 5 CCTOF : 定電流階段充電超時旗標

0 = 定電流階段充電未超時

1 = 定電流階段充電超時

Bit 6 CVTOF : 定電壓階段充電超時旗標

0 = 定電壓階段充電未超時

1 = 定電壓階段充電超時

Bit 7 FTOF : 浮充階段充電超時旗標

0 = 浮充階段充電未超時

1 = 浮充階段充電超時

Note: 不支援顯示 狀態，以0做顯示

2 Stage Charge

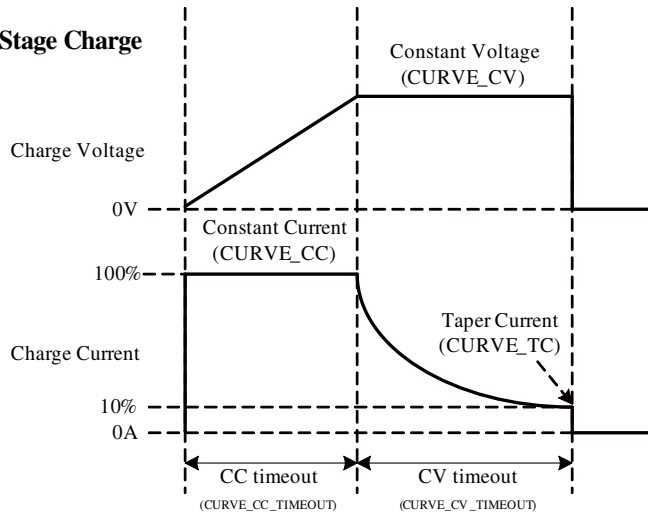

3 Stage Charge

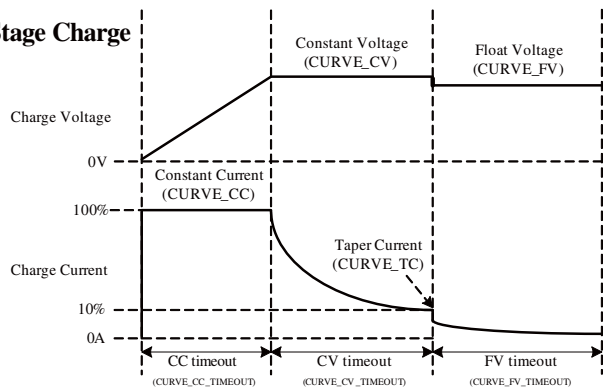

◎ SCALING_FACTOR(0x00C0-0x00C2)定義如下：

	Bit7	Bit6	Bit5	Bit4	Bit3	Bit2	Bit1	Bit0
Byte5	Reserved				Reserved			
	Bit7	Bit6	Bit5	Bit4	Bit3	Bit2	Bit1	Bit0
Byte4	Reserved				Reserved			
	Bit7	Bit6	Bit5	Bit4	Bit3	Bit2	Bit1	Bit0
Byte3	Reserved				IIN Factor			
	Bit7	Bit6	Bit5	Bit4	Bit3	Bit2	Bit1	Bit0
Byte2	CURVE_TIMEOUT Factor				TEMPERATURE_1 Factor			
	Bit7	Bit6	Bit5	Bit4	Bit3	Bit2	Bit1	Bit0
Byte1	FAN_SPEED Factor				VIN Factor			
	Bit7	Bit6	Bit5	Bit4	Bit3	Bit2	Bit1	Bit0
Byte0	IOUT Factor				VOUT Factor			

Byte0:

Bit 0:3 VOUT Factor : 輸出電壓 Factor

0x0=不支援VOUT相關命令

0x1~0x3=目前未使用，保留(default為0)

0x4=0.001

0x5=0.01

0x6=0.1

0x7=1.0

0x8=10

0x9=100

0xA~0xF= Reserved

Bit 4:7 IOUT Factor : 輸出電流 Factor

0x0=不支援IOUT相關命令

0x1~0x3=目前未使用，保留(default為0)

0x4=0.001

0x5=0.01

0x6=0.1

0x7=1.0

0x8=10

0x9=100

0xA~0xF= Reserved

Byte1:

Bit 0:3 VIN Factor : 輸入電壓 Factor

- 0x0=不支援VIN相關命令
- 0x1~0x3=目前未使用·保留(default為0)
- 0x4=0.001
- 0x5=0.01
- 0x6=0.1
- 0x7=1.0
- 0x8=10
- 0x9=100
- 0xA~0xF= Reserved

Bit 4:7 FAN_SPEED Factor : 風扇轉速 Factor

- 0x0=不支援FAN相關命令
- 0x1~0x3=目前未使用·保留(default為0)
- 0x4=0.001
- 0x5=0.01
- 0x6=0.1
- 0x7=1.0
- 0x8=10
- 0x9=100
- 0xA~0xF= Reserved

Byte2:

Bit 0:3 TEMPERATURE_1 Factor : 內環溫 Factor

- 0x0=不支援TEMPERATURE_1相關命令
- 0x1~0x3=目前未使用·保留(default為0)
- 0x4=0.001
- 0x5=0.01
- 0x6=0.1
- 0x7=1.0
- 0x8=10
- 0x9=100

Bit 4:7 CURVE_TIMEOUT Factor : 定電流、定電壓、浮充充電超時時間 Factor

- 0x0=不支援CURVE_TIMEOUT相關命令
- 0x1~0x3=目前未使用·保留(default為0)
- 0x4=0.001
- 0x5=0.01
- 0x6=0.1
- 0x7=1.0
- 0x8=10
- 0x9=100
- 0xA~0xF= Reserved

Byte3:

Bit 0:3 IIN Factor : 輸入電流 Factor

- 0x0=不支援IIN相關命令
- 0x1~0x3=目前未使用·保留(default為0)
- 0x4=0.001
- 0x5=0.01
- 0x6=0.1
- 0x7=1.0
- 0x8=10
- 0x9=100
- 0xA~0xF= Reserved

Bit 4:7 Reserved : 目前未使用·保留(default為0)

Byte4~Byte5:

Bit 0:7 Reserved : 目前未使用·保留(default為0)

◎ SYSTEM_STATUS(0x00C3)定義如下:

	Bit7	Bit6	Bit5	Bit4	Bit3	Bit2	Bit1	Bit0
High byte	Reserved	Reserved	Reserved	Reserved	Reserved	Reserved	Reserved	Reserved
Low byte	CHG/ UPS	EEPER	INITIAL_ STATE	ADL_ON	ORING_ OFF	PFC_OK	DC_OK	M/S

Low byte:

- Bit 0 M/S : 並聯模式狀態 (不支援)
0 = 當前機器為Slave
1 = 當前機器為Master
- Bit 1 DC_OK : 二次側DC輸出電壓狀態
0 = 二次側輸出電壓過低
1 = 二次側輸出電壓正常
- Bit 2 PFC_OK : 一次側PFC狀態 (不支援)
0 = 一次側PFC 未啟動或有異常
1 = 一次側PFC已正常啟動
- Bit 3 ORING_OFF : ORING MOS關閉控制狀態 (不支援)
0 = DD啟動後交由ORING MOS controller作控制
1 = DD啟動後強制控制ORING MOS OFF
- Bit 4 ADL_ON : Active dummy load控制狀態 (不支援)
0 = 關閉Active dummy load
1 = 啟動Active dummy load
- Bit 5 INITIAL_STATE : 機器初始化狀態
0 = 當前機器未處於初始化狀態
1 = 當前機器處於初始化狀態
- Bit 6 EEPER : EEPROM資料存取錯誤
0 = EEPROM資料存取正常
1 = EEPROM資料存取錯誤
- Bit 7 CHG/UPS : 工作狀態
0 = 當前狀態為Charging mode
1 = 當前狀態為UPS mode

High byte:

Bit 0:7 Reserved : 目前未使用, 保留(default為0)

Note: 不支援顯示 狀態, 以0做顯示

◎ SYSTEM_CONFIG(0x00C4)定義如下:

	Bit7	Bit6	Bit5	Bit4	Bit3	Bit2	Bit1	Bit0
High byte	Reserved	Reserved	Reserved	Reserved	Reserved	Reserved	Reserved	Reserved
Low byte	Reserved	Reserved	Reserved	Reserved	Reserved	OPERATION_INIT	MOD_CTRL	

Low byte:

- Bit 0 MOD_CTRL : ModBus通訊控制狀態 (不支援)
0 = 當前機器的輸出電壓、電流控制來源為SVR
1 = 當前機器的輸出電壓、電流、開啟/關閉控制控制來源為Modbus通訊之設定值
- Bit 1:2 OPERATION_INIT : 開機時OPERATION指令 預設值
0b00 = 開機預設為0x00(OFF)
0b01 = 開機預設為0x01(ON)
0b10 = 開機預設為前一次 設定值
0b11 = 目前未使用, 保留
- Bit 3:7 Reserved : 目前未使用, 保留(default為0)

High byte:

Bit 0:7 Reserved : 目前未使用, 保留(default為0)

Note: 不支援顯示 狀態, 以0做顯示

◎ UPS_CONFIG(0x00D2)定義如下:

	Bit7	Bit6	Bit5	Bit4	Bit3	Bit2	Bit1	Bit0
High byte	Reserved	Reserved	Reserved	Reserved	Reserved	Reserved	Reserved	Reserved
Low byte	Reserved	Reserved	Reserved	Reserved	Reserved	Time_Buff_EN	UPS_OFF_EN	Life_Test_EN

Low byte:

- Bit 0 Life_Test_EN : 電池自檢功能致能
0 = 關閉
1 = 開啟(default)
- Bit 1 UPS_OFF_EN : 強制啟動狀態通過button關機功能致能
0 = 關閉(default)
1 = 開啟
- Bit 2 Time_Buff_EN : Time_Buffering時間設定功能致能
0 = 關閉(default)
1 = 開啟
- Bit 3:7 Reserved : 目前未使用, 保留(default為0)

High byte :

Bit 0:7 Reserved : 目前未使用, 保留(default為0)

Note: 不支援顯示 狀態, 以0做顯示

5.4.2 通訊範例

以下將提供Modbus RTU協定讀與寫 範例。

5.4.2.1 Read Holding Register (FC=03)

請求訊息需指定要讀取 起始暫存器及暫存器 數量

例如：主控端欲讀取3號設備0x0080~0x0085(MFR_ID_B0B5, MFR_ID_B6B11) 狀態

請求：

0x83	0x03	0x00 80	0x00 06	0xDA 02
------	------	---------	---------	---------

0x83 : Slave ID 3

0x03 : Function code 3 (讀取參數暫存器)

0x00 80 : 製造商名稱 起始暫存器位址

0x00 06 : 請求之暫存器總數 (請取0x0080~ 0x0085之狀態值)

0xDA 02 : CRC-16錯誤檢查 · 請注意CRC由low byte先傳送

回應：

0x83	0x03	0x0C	0x4D 45 41 4E 57 45 4C 4C 20 20 20 20	0x4A 8C
------	------	------	--	---------

0x83 : Slave ID 3

0x03 : Function code 3 (讀取參數暫存器)

0x0C : 位元組計數 (byte count) · 表示後續有12byte 資料

0x4D 45 41 4E 57 45 4C 4C 20 20 20 20 : 表示為DRS-480編號3 製造商名稱

0x4A 8C : CRC-16錯誤檢查 · 請注意CRC由low byte先傳送

5.4.2.2 Read Input Register (FC=04)

請求訊息需指定要讀取 起始暫存器及暫存器 數量

例如：主控端欲讀取3號設備0x0060 (READ_VOUT) 資料

請求：

0x83	0x04	0x00 60	0x00 01	0x2F F6
------	------	---------	---------	---------

0x83 : Slave ID 3

0x04 : Function code 4 (讀取類比暫存器)

0x00 60 : 起始暫存器位址

0x00 01 : 請求之暫存器總數 (請取0x0060之資料值)

0x2F F6 : CRC-16錯誤檢查 · 請注意CRC由low byte先傳送

回應：

0x83	0x04	0x02	0x15 7C	0xCE 5F
------	------	------	---------	---------

0x83 : Slave ID 3

0x04 : Function code 4 (讀取類比暫存器)

0x02 : 位元組計數 (byte count) · 表示後續有2byte 資料

0x15 7C : HEX 0x15 7C = DEC 5500 = 55.00V

0xCE 5F : CRC-16錯誤檢查 · 請注意CRC由low byte先傳送

5.4.2.3 Write Single Register (FC=06)

請求訊息需指定要寫入 暫存器位元址及內容

例如：主控欲寫入3號設備0x0000 (Operation) 狀態值為開機 (ON)

請求：

0x83	0x06	0x00 00	0x00 01	0x56 28
------	------	---------	---------	---------

0x83 : Slave ID 3

0x06 : Function code 6 (寫入單一暫存器)

0x00 00 : 起始暫存器位址

0x00 01 : 寫入開啟命令0x0001

0x56 28 : CRC-16錯誤檢查 · 請注意CRC由low byte先傳送

回應：

如傳輸成功 · Slave會回傳與請求內容完全相同 資訊。

5.4.3 CANBus通訊

- 實體層傳輸

本協定採用CAN ISO-11898 · Baud rate為250Kbps。

- 協定框架格式

本協定採用CAN 2.0B · 使用擴充型資料框 傳輸格式。

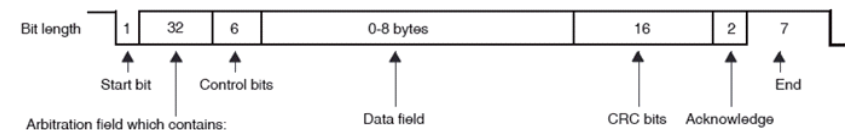

– 29-bit identifier + SRR bit + IDE bit + RTR bit for extended frame format
Where: RTR = Remote Transmission Request
SRR = Substitute Remote Request
IDE = Identifier Extension

● 通訊時序

最小請求週期 (Controller to PSU/CHG): 20mSec ◦

最大響應時間 (PSU/CHG to Controller): 5mSec ◦

最小數據包間隔時間 (Controller to PSU/CHG): 5mSec ◦

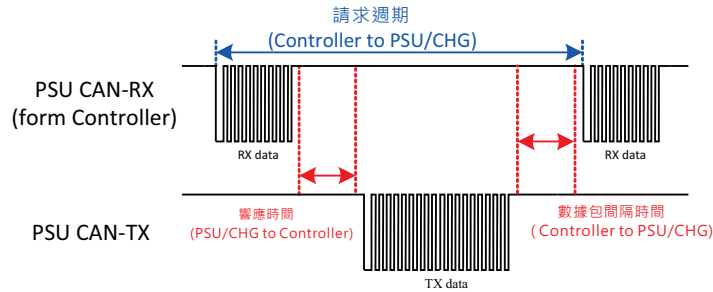

5.4.3.1 Message ID

敘述	Message ID
DRS對控制器Message ID	0x000C00XX
控制器對DRSMessage ID	0x000C01XX
控制器對DRS廣播Message ID	0x000C01FF

PS : XX代表該DRS之位址(由定址訊號A0~A1決定 · 範圍為0x00 ~ 0x03)

5.4.3.2 CANBus命令支援表

Command Code	Command Name	Transaction Type	# of data Bytes	Description
0x0000	OPERATION	R/W	1	開啟 / 關閉控制
0x0020	VOUT_SET	R/W	2	輸出電壓設定 (format: value, F=0.01)
0x0040	FAULT_STATUS	R	2	異常狀態
0x0050	READ_VIN	R	2	輸入電壓讀值 (format: value, F=0.1)

0x0060	READ_VOUT	R	2	輸出電壓讀值 (format: value, F=0.01)
0x0061	READ_IOUT	R	2	輸出電流讀值 (format: value, F=0.01)
0x0062	READ_TEMPERATURE_1	R	2	內環境溫度讀值 (format: value, F=0.1)
0x0080	MFR_ID_B0B5	R	6	製造商名稱
0x0081	MFR_ID_B6B11	R	6	製造商名稱
0x0082	MFR_MODEL_B0B5	R	6	製造商機型名稱
0x0083	MFR_MODEL_B6B11	R	6	製造商機型名稱
0x0084	MFR_REVISION_B0B5	R	6	韌體版本
0x0085	MFR_LOCATION_B0B2	R/W	3	製造產地
0x0086	MFR_DATE_B0B5	R/W	6	製造日期
0x0087	MFR_SERIAL_B0B5	R/W	6	製造序號
0x0088	MFR_SERIAL_B6B11	R/W	6	製造序號
0x00B0	CURVE_CC	R/W	2	充電曲線定電流 (format: value, F=0.01)
0x00B1	CURVE_CV	R/W	2	充電曲線定電壓 (format: value, F=0.01)
0x00B2	CURVE_FV	R/W	2	充電曲線浮充電壓 (format: value, F=0.01)
0x00B3	CURVE_TC	R/W	2	充電曲線轉態電流 (format: value, F=0.01)
0x00B4	CURVE_CONFIG	R/W	2	充電器功能

0x00B5	CURVE_CC_TIMEOUT	R/W	2	充電曲線定電流充電計時
0x00B6	CURVE_CV_TIMEOUT	R/W	2	充電曲線定電壓充電計時
0x00B7	CURVE_FV_TIMEOUT	R/W	2	充電曲線浮充充電計時
0x00B8	CHG_STATUS	R	2	充電器狀態
0x00C0	SCALING_FACTOR	R	2	比例因數
0x00C1	SYSTEM_STATUS	R	2	系統狀態
0x00C2	SYSTEM_CONFIG	R/W	2	系統設定
0x00D0	BAT_UVP_SET	R/W	2	BAT_LOW 保護點設定
0x00D1	Force_BAT_UVP_SET	R/W	2	強制啟動狀態 BAT_LOW 保護點設定
0x00D2	UPS_CONFIG	R/W	2	UPS 模式設定
0x00D3	READ_VBAT	R	2	電池電壓 (format: value, F=0.01)
0x00D4	READ_IBAT	R	2	電池充放電電流 (format: value, F=0.01)
0x00D5	READ_BAT_TEMPERATURE	R	2	電池溫度 (format: value, F=0.1)
0x00D6	CHARGE_CYCLES	R/W	2	充電循環統計(不支援)
0x00D7	AH_CHARGED	R/W	2	充電容量(不支援)
0x00E0	AC_Fail_LL_SET	R/W	2	AC Lo_line 轉應急轉換點設定
0x00E1	AC_Fail_HL_SET	R/W	2	AC Hi_line 轉應急轉換點設定
0x00E2	AC_OK_LL_SET	R/W	2	AC Lo_line 應急轉主電轉換點設定

0x00E3	AC_OK_HL_SET	R/W	2	AC Hi_line 應急轉主電轉換點設定
0x00E4	TIME_BUFFERING	R/W	2	備源時間設定
0x00E5	BACKUP	R/W	2	備源次數統計(不支援)
0x00E6	RUN TIME	R/W	4	電源運行時間(不支援)

Note: 設定、讀取數值換算定義如下:

實際值 = 通訊讀值 × Factor(F值)。中Factor需參照各機型清單
SCALING_FACTOR定義。

EX: Vo_real(輸出電壓實際值) = READ_VOUT × Factor。

若某機型READ_VOUT Factor為0.01、通訊讀值為0x0960(16進
制)=>2400(10進制)，則Vo_real = 2400 × 0.01 = 24.00V。

◎ FAULT_STATUS(0x0040)定義如下:

Bit7	Bit6	Bit5	Bit4	Bit3	Bit2	Bit1	Bit0
High byte	Reserved	Reserved	Reserved	Reserved	Reserved	Reserved	Reserved
Low byte	OP_OFF	AC_FAIL	SHORT	OLP	OVP	OTP	FAN_FAIL

Low byte:

Bit 0 FAN_FAIL: 風扇異常狀態(不支援)

0 = 風扇正常

1 = 風扇異常

Bit 1 OTP: 過溫度保護狀態

0 = 非處於過溫度保護

1 = 處於過溫度保護

Bit 2 OVP: 輸出過電壓保護狀態

0 = 非處於輸出過電壓保護

1 = 處於輸出過電壓保護

Bit 3 OLP: 過載保護狀態

0 = 非處於過載保護

1 = 處於過載保護

Bit 4 SHORT: 短路保護狀態

0 = 非處於短路保護

1 = 處於短路保護

Bit 5 AC_FAIL : 輸入電壓異常保護狀態

0 = 非處於輸入電壓異常保護

1 = 處於輸入電壓異常保護

Bit 6 OP_OFF : 輸出關閉指示

0 = 處於輸出開啟

1 = 處於輸出關閉

Bit 7 HI_TEMP : 環溫過高警告

0 = 處於環溫正常

1 = 處於環溫過高

High byte:

Bit 0:7 Reserved : 目前未使用 · 保留(default為0)

Note: 不支援顯示 狀態 · 以0做顯示

◎ MFR_ID_B0B5(0x0080)為製造商名稱前6碼;

MFR_ID_B6B11(0x0081)為製造商名稱後6碼(以ASCII表示)

EX:製造商為MEANWELL MFR ID B0B5為MEANWE; MFR_ID_B6B11為LL

MFR_ID_B0B5					
Byte 0	Byte 1	Byte 2	Byte 3	Byte 4	Byte 5
0x4D	0x45	0x41	0x4E	0x57	0x45

MFR_ID_B6B11					
Byte 0	Byte 1	Byte 2	Byte 3	Byte 4	Byte 5
0x4C	0x4C	0x20	0x20	0x20	0x20

◎ MFR_MODEL_B0B5(0x0082)為機型碼前6碼;

MFR_MODEL_B6B11(0x0083)為機型碼後6碼(以ASCII表示)

EX: 機型DRS-480-24 MFR_MODEL_B0B5為DRS-48;

MFR_MODEL_B6B11為0-24

MFR_MODEL_B0B5					
Byte 0	Byte 1	Byte 2	Byte 3	Byte 4	Byte 5
0x44	0x52	0x53	0x2D	0x34	0x38

MFR_ID_B6B11					
Byte 6	Byte 7	Byte 8	Byte 9	Byte 10	Byte 11
0x30	0x2D	0x32	0x34	0x20	0x20

◎ MFR_REVISION_B0B5(0x0084)最多可表示六個MCU的韌體版本(以Binary表示) · 其中順序依韌體程式料號編碼中的MCU編號 · 一個MCU的韌體版本範圍為0x00(R00.0)~0xFE(R25.4) · 無版本的部分以0xFF表示 ·

EX1: PSU產品有六顆MCU · MCU編號為1的韌體版本為R01.3版(0x0D) · 編號為2 韌體為R01.2版(0x0C) · 編號為3 韌體為R01.1版(0x0B) · 其餘的為R01.0版(0x0A)

Byte 0	Byte 1	Byte 2	Byte 3	Byte 4	Byte 5
0x0D	0x0C	0x0B	0x0A	0x0A	0x0A

EX2: PSU產品有三顆MCU · MCU編號為1的韌體版本為R25.4版(0xFE) · 編號為2 韌體為R10.5版(0x69) · 編號為3 韌體為R01.0版(0x0A)

Byte 0	Byte 1	Byte 2	Byte 3	Byte 4	Byte 5
0xFE	0x69	0x0A	0xFF	0xFF	0xFF

◎ MFR_DATE_B0B5(0x0086)定義為西元後兩碼加上日期四碼(以ASCII表示)

EX: 製造日期為2018年1月1號 MFR_DATE_B0B5為180101

Byte 0	Byte 1	Byte 2	Byte 3	Byte 4	Byte 5
0x31	0x38	0x30	0x31	0x30	0x31

◎ MFR_SERIAL_B0B5(0x0087) · MFR_SERIAL_B6B11(0x0088)定義為製造日期六碼加上製造序號六碼(以ASCII表示)

EX: 2018年1月1號製造 · 序號第一台MFR_SERIAL_B0B5為180101;

MFR_SERIAL_B6B11為000001

Byte 0	Byte 1	Byte 2	Byte 3	Byte 4	Byte 5
0x31	0x38	0x30	0x31	0x30	0x31

Byte 0	Byte 1	Byte 2	Byte 3	Byte 4	Byte 5
0x30	0x30	0x30	0x30	0x30	0x31

◎ CURVE_CONFIG(0x00B4)(only for charger)定義如下：

								Bit0	
Highbyte	Reserved	Reserved	Reserved	Reserved	Reserved	FVTOE	CVTOE	CCTOE	
Lowbyte	CUVE	STGS	Reserved	Reserved	TCS		CUVS		

Low byte:

Bit 0:1 CUVS：充電曲線選擇（不支援）

00 = 載入客戶燒錄充電曲線(default)

01 = 載入預設充電曲線#1

10 = 載入預設充電曲線#2

11 = 載入預設充電曲線#3

Bit 2:3 TCS：溫度補償設定

00 = disable

01 = -3 mV/°C/cell (default)

10 = -4 mV/°C/cell

11 = -5 mV/°C/cell

Bit 4:5 Reserved：目前未使用，保留(default為0)

Bit 6 STGS：2/3段充電設定

0 = 3段充電 (default)

1 = 2段充電

Bit 7 CUVE：充電曲線致能（default為1）

0 = 關閉(VI mode)

1 = 開啟(Curve mode)

High byte:

Bit 0 CCTOE：CC timeout致能

0 = 關閉 (default)

1 = 開啟

Bit 1 CVTOE：CV timeout致能

0 = 關閉 (default)

1 = 開啟

Bit 2 FTTOE：Floating timeout致能

0 = 關閉 (default)

1 = 開啟

Bit 3:7 Reserved：目前未使用，保留(default為0)

Note: 不支援 設定，以0做顯示

◎ CHG_STATUS(0x00B8)(only for charger)定義如下：

	Bit7	Bit6	Bit5	Bit4	Bit3	Bit2	Bit1	Bit0
Highbyte	FVTOF	CVTOF	CCTOF	BUFFTOF	BTNC	NTCER	Reserved	Reserved
Low byte	DCM	Reserved	Reserved	Reserved	FVM	CVM	CCM	FULLM

Low byte:

Bit 0 FULLM：充飽電模式狀態

0 = 未充飽電

1 = 充飽電

Bit 1 CCM：定電流充電模式狀態

0 = 充電器非處於定電流模式

1 = 充電器處於定電流模式

Bit 2 CVM：定電壓充電模式狀態

0 = 充電器非處於定電壓模式

1 = 充電器處於定電壓模式

Bit 3 FVM：浮充模式狀態

0 = 充電器非處於浮充模式

1 = 充電器處於浮充模式

Bit 4:6 Reserved：目前未使用，保留(default為0)

Bit 7 DCM：電池放電模式狀態

0 = 電池處於充電狀態

1 = 電池處於放電狀態

High byte:

Bit 0:1 Reserved：目前未使用，保留(default為0)

Bit 2 NTCER：溫度補償短路

0 = 溫度補償線路無發生短路

1 = 溫度補償線路發生短路

Bit 3 BTNC：電池未接

0 = 偵測到電池

1 = 未偵測到電池

Bit 4 BUFFTOF：備源使用超時旗標

0 = 備源模式電池放電未超時

1 = 備源模式電池放電超時

- Bit 5 CCTOF : 定電流階段充電超時旗標
0 = 定電流階段充電未超時
1 = 定電流階段充電超時
- Bit 6 CVTOF : 定電壓階段充電超時旗標
0 = 定電壓階段充電未超時
1 = 定電壓階段充電超時
- Bit 7 FVTOF : 浮充階段充電超時旗標
0 = 浮充階段充電未超時
1 = 浮充階段充電超時

Note: 不支援顯示 狀態，以0做顯示

充電曲線示意圖:

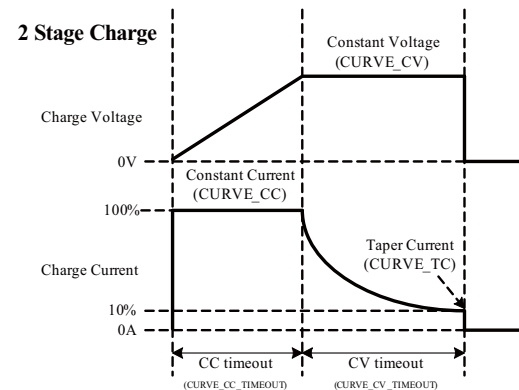
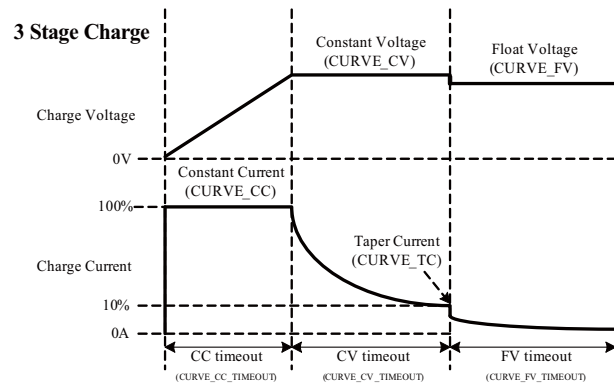

◎ SYSTEM_STATUS(0x00C1)定義如下:

	Bit7	Bit6	Bit5	Bit4	Bit3	Bit2	Bit1	Bit0
High byte	Reserved	Reserved	Reserved	Reserved	Reserved	Reserved	Reserved	Reserved
Low byte	CHG/UPS	EEPER	INITIAL_STATE	ADL_ON	ORING_OFF	PFC_OK	DC_OK	M/S

Low byte:

- Bit 0 M/S : 並聯模式狀態 (不支援)
0 = 當前機器為Slave
1 = 當前機器為Master
- Bit 1 DC_OK : 二次側DC輸出電壓狀態
0 = 二次側輸出電壓過低
1 = 二次側輸出電壓正常
- Bit 2 PFC_OK : 一次側PFC狀態 (不支援)
0 = 一次側PFC未啟動或有異常
1 = 一次側PFC已正常啟動
- Bit 3 ORING_OFF : ORING MOS關閉控制狀態 (不支援)
0 = DD啟動後交由ORING MOS controller作控制
1 = DD啟動後強制控制ORING MOS OFF
- Bit 4 ADL_ON : Active dummy load控制狀態 (不支援)
0 = 關閉Active dummy load/不支援此狀態顯示
1 = 啟動Active dummy load
- Bit 5 INITIAL_STATE : 機器初始化狀態
0 = 當前機器未處於初始化狀態
1 = 當前機器處於初始化狀態
- Bit 6 EEPER : EEPROM資料存取錯誤
0 = EEPROM資料存取正常
1 = EEPROM資料存取錯誤
- Bit 7 CHG/UPS : 工作狀態
0 = 當前狀態為Charging mode
1 = 當前狀態為UPS mode

High byte:

Bit 0:7 Reserved : 目前未使用，保留(default為0)

Note: 不支援顯示 狀態，以0做顯示

◎ SYSTEM_CONFIG(0x00C2)定義如下：

	Bit7	Bit6	Bit5	Bit4	Bit3	Bit2	Bit1	Bit0
High byte	Reserved	Reserved	Reserved	Reserved	Reserved	Reserved	Reserved	Reserved
Low byte	Reserved	Reserved	Reserved	Reserved	Reserved	OPERATION_INIT		CAN_CTRL

Low byte:

Bit 0 CAN_CTRL : CANBus通訊控制狀態 (不支援)

0 = 當前機器的輸出電壓、電流控制來源為SVR

1 = 當前機器的輸出電壓、電流、開啟/關閉控制控制來源為CANBus通訊之設定值

Bit 1:2 OPERATION_INIT : 開機時OPERATION指令 預設值

0b00 = 開機預設為0x00(OFF)

0b01 = 開機預設為0x01(ON)

0b10 = 開機預設為前一次 設定值

0b11 = 目前未使用·保留

Bit 3:7 Reserved : 目前未使用·保留(default為0)

High byte:

Bit 0:7 Reserved : 目前未使用·保留(default為0)

Note: 不支援顯示 狀態·以0做顯示

◎ UPS_CONFIG(0x00D2)定義如下：

	Bit7	Bit6	Bit5	Bit4	Bit3	Bit2	Bit1	Bit0
High byte	Reserved	Reserved	Reserved	Reserved	Reserved	Reserved	Reserved	Reserved
Low byte	Reserved	Reserved	Reserved	Reserved	Reserved	Time_Buff_EN	UPS_OFF_EN	Life_Test_EN

Low byte:

Bit 0 Life_Test_EN : 電池自檢功能致能

0 = 關閉

1 = 開啟(default)

Bit 1 UPS_OFF_EN : 強制啟動狀態通過button關機功能致能

0 = 關閉(default)

1 = 開啟

Bit 2 Time_Buff_EN : Time_Buffering時間設定功能致能

0 = 關閉(default)

1 = 開啟

Bit 3:7 Reserved : 目前未使用·保留(default為0)

High byte :

Bit 0:7 Reserved : 目前未使用·保留(default為0)

Note: 不支援顯示 狀態·以0做顯示

5.4.4 數值範圍與誤差

(1) 顯示參數

	CANBus/Modbus Command	機型	顯示數值範圍	顯示誤差	
0x0050	READ_VIN	ALL	80 ~ 305V	±2V	
0x0060	READ_VOUT	12V	0 ~ 15V	±0.12V	
		24V	0 ~ 30V	±0.24V	
		36V	0 ~ 45V	±0.36V	
		48V	0 ~ 60V	±0.48V	
0x0061	READ_IOUT	DRS-240	12V	0 ~ 20A	±0.2A
			24V	0 ~ 10A	±0.1A
			36V	0 ~ 6.6A	±0.066A
			48V	0 ~ 5A	±0.05A
		DRS-480	24V	0 ~ 20A	±0.2A
			36V	0 ~ 13.3A	±0.13A
			48V	0 ~ 10A	±0.1A
			0x0062	READ_TEMPERATURE_1	ALL
0x00D3	READ_VBAT	12V	0 ~ 15V	±0.12V	
		24V	0 ~ 30V	±0.24V	
		36V	0 ~ 45V	±0.36V	
		48V	0 ~ 60V	±0.48V	
0x00D4	READ_IBAT	DRS-240	12V	-40 ~ 20A	±0.2A
			24V	-20 ~ 10A	±0.1A
			36V	-13.2 ~ 6.6A	±0.066A
			48V	-10 ~ 5A	±0.05A
		DRS-480	24V	-40 ~ 20A	±0.2A
			36V	-26.6 ~ 13.3A	±0.13A
			48V	-40 ~ 20A	±0.1A
			0x00D5	READ_BAT_TEMPERATURE	ALL

(2) 設定參數

1	CANBus/Modbus Command	機型	可控制數值範圍	控制誤差	預設值	
0x0000	OPERATION	ALL	00h(OFF)/01h(ON)	N/A	01h(ON)	
0x0020	VOUT_SET	12V	10 ~ 14V	±0.12V	12V	
		24V	20 ~ 28V	±0.24V	24V	
		36V	30 ~ 42V	±0.36V	36V	
		48V	40 ~ 56V	±0.48V	48V	
0x00B0	CURVE_ICHG	DRS-240	12V	4 ~ 20A	±0.2A	20A
			24V	2 ~ 10A	±0.1A	10A
			36V	1.32 ~ 6.6A	±0.066A	6.6A
			48V	1 ~ 5A	±0.05A	5A

0x00B0	CURVE_ICHG	DRS-480	24V	4 ~ 20A	±0.2A	20A
			36V	2.66 ~ 13.3A	±0.13A	13.3A
			48V	2 ~ 10A	±0.1A	10A
0x00B1	CURVE_VBST	12V	9 ~ 15V	±0.12V	14.4V	
		24V	18 ~ 30V	±0.24V	28.8V	
		36V	27 ~ 45V	±0.36V	43.2V	
		48V	36 ~ 60V	±0.48V	57.6V	
0x00B2	CURVE_VFLOAT	12V	9V ~ VBST	±0.12V	13.8V	
		24V	18V ~ VBST	±0.24V	27.6V	
		36V	27V ~ VBST	±0.36V	41.4V	
		48V	36V ~ VBST	±0.48V	55.2V	
0x00B3	CURVE_ITAPER	DRS-240	12V	0.4 ~ 2A	±0.2A	2A
			24V	0.2 ~ 1A	±0.1A	1A
			36V	0.13 ~ 0.66A	±0.066A	0.66A
		DRS-480	48V	0.1 ~ 0.5A	±0.05A	0.5A
			24V	0.4 ~ 2A	±0.2A	2A
			36V	0.27 ~ 1.33A	±0.133A	1.33A
48V	0.2 ~ 1A	±0.1A	1A			
0x00B5	CURVE_CC_TIME OUT	ALL	60 ~ 64800 minute	±5 minute	600 minute	
0x00B6	CURVE_CV_TIME OUT					
0x00B7	CURVE_FLOAT_TIMEOUT					
0x00D0	BAT_UVP_SET	12V	9.6 ~ 12V	±0.12V	10.44V	
		24V	19.2 ~ 24V	±0.24V	20.88V	
		36V	28.8 ~ 36V	±0.36V	31.32V	
		48V	38.4 ~ 48V	±0.48V	41.76V	
0x00D1	Force_BAT_UVP_SET	12V	8.4 ~ 12V	±0.12V	8.4V	
		24V	16.8 ~ 24V	±0.24V	16.8V	
		36V	25.2 ~ 36V	±0.36V	25.2V	
48V	33.6 ~ 48V	±0.48V	33.6V			
0x00E0	AC_Fail_LL_SET	ALL	82 ~ 120V	±5V	82Vac	
0x00E1	AC_Fail_HL_SET	ALL	132 ~ 182V	±5V	171.6Vac	
0x00E2	AC_OK_LL_SET	ALL	87~125V	±5V	87Vac	
0x00E3	AC_OK_HL_SET	ALL	137 ~ 187V	±5V	182.6Vac	
0x00E4	TIME_BUFFERING	ALL	60 ~ 64800 minute	±5 minute	600 minute	

5.5 警報信號

警報信號包含：AC Fail信號，DC OK信號，電池低壓/異常/斷開連接信號以及Charger Fail信號。

INPUT	AC Fail		DC OK		Battery low/Abnormal/Disconnected		Charger Fail	
	2-3	1-3	5-6	4-6	8-9	7-9	11-12	10-12
AC only	closed	open	closed	open	open	closed	-----	-----
AC + BAT.	closed	open	closed	open	closed	open	-----	-----
BAT. only	open	closed	closed	open	closed	open	-----	-----
Low BAT. (<30% capacity)	-----	-----	-----	-----	open	closed	-----	-----
Charger Fail	-----	-----	-----	-----	-----	-----	open	closed

1. 警報信號通過觸發繼電器後由 " AC Fail " & " DC OK " & " Battery low " & " Charger Fail " 引腳送出。
2. 此功能需要一個外部電壓源；最大工作電壓為30Vdc,最大拉載電流為1A。

AC Fail/DC OK/電池電壓低/Charger Fail

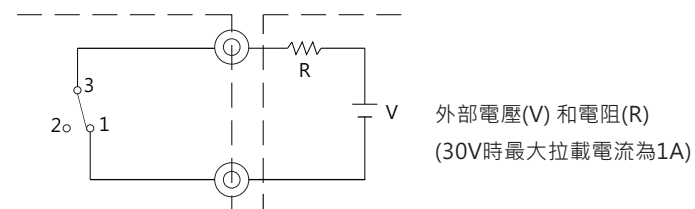

5.5.1 AC Fail 警報信號

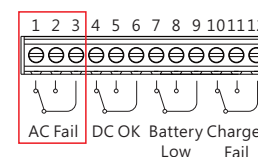

狀態	2-3	1-3
僅主電供電	短路	開路
主電+備電(電池)供電	短路	開路
僅備電(電池)供電	開路	短路

5.5.2 DC OK 警報信號

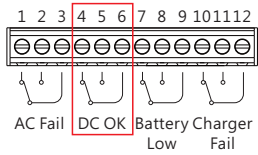

狀態	5-6	4-6
DC輸出正常	短路	開路
DC輸出異常	開路	短路

5.5.3 電池電壓低/反接/未接警報信號

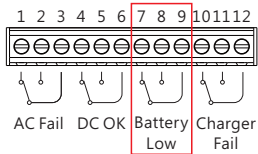

狀態	8-9	7-9
電池電壓正常	短路	開路
電池電壓低/反接/未接	開路	短路

5.5.4 Charger Fail警報信號

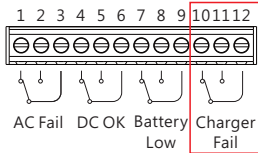

狀態	11-12	10-12
充電正常	短路	開路
充電異常	開路	短路

5.6 電池啟動功能

無交流電網接入時，系統可通過電池直接啟動

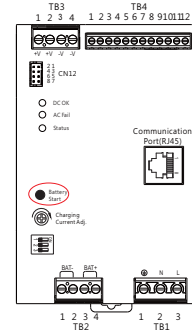

5.6.1 通過Battery Start 按鈕，短按啟動電池供電

5.6.2 長按Battery Start按鈕3秒後鬆開，電池供電斷開

5.6.3 電池電壓過低會觸發欠壓保護(12V : 10.5±0.3V ; 24V : 20.9±0.5 ; 36V : 31.3±0.7V ; 48V : 41.8±1V)

5.6.4 電池供電狀態下，如有AC電重新接入，則自動切換為AC供電

5.7 強制啟動功能

無AC電網接入時，系統可由電池強制啟動

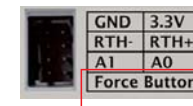

5.7.1 CN12 7,8腳短路啟動(啟動後建議斷開，避免5.7.2功能失效)

5.7.2 長按Battery Start按鈕3秒後鬆開，電池供電斷開

5.7.3 電池電壓過低會觸發欠壓保護 (12V : 10±0.3V ; 24V : 16.8±0.5 ; 36V : 25.2±0.7V ; 48V : 33.6±1V)

5.7.4 強制啟動狀態下，如有AC電重新接入，則自動切換為AC供電

5.8 溫度補償功能

溫度補償功能主要是減小溫度對蓄電池化學反應活性 影響。使用溫度補償功能時，請將隨貨附加 溫度感測器 (NTC) 線附著在電池上或 周圍環境中。如果沒有使用溫度感測器 (NTC) ，DRS產品仍可正常工作。

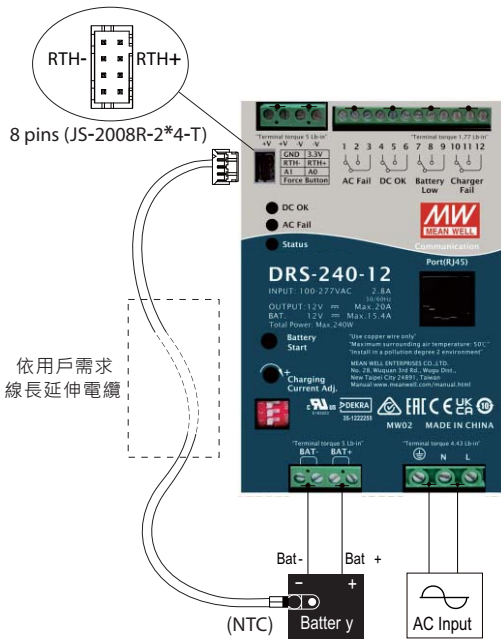

5.8.4 配件列表

※ NTC 傳感器和遠程控制配合DRS(標準配件)

物件	數量
1 Part No.: NGS05C250J5 NTC傳感器線 50 7 UL2468 24x2C NTC(RTH+) NTC(RTH-)	1
2 遙控配合線 50 7 UL1007 28AWG JS-2007-2*4-T 或同等級	1

連接圖
圖示展示了連接線的佈局：一端連接到DRS面板上的8針接口，中間是依用戶需求線長的延伸電纜，另一端連接到電池。

5.8.1. 補償參數可以通過CANBus,Modbus通訊命令選擇修改，可選擇 Disable、-3、-4或-5mV/°C/Cell四檔，出廠預設為-3mV/°C/Cell。

5.8.2. 若不接溫度補償電阻則當作常溫，不予補償；且溫度補償只會補償鉛酸電池，不會補償鋰鐵電池。

5.8.3. 溫度補償範圍為0-40°C，25°C常溫為中心值，不補償；當溫度<0°C或>40°C時，不再繼續補償，當前溫度補償值會被限制在0°C或40°C。

以24V機型為例

假設 V_{boost} 設定為28.8V，溫度補償通過通訊設定為-5mV/°C/Cell。

TEMP_bat 為感測器(NTC)檢測溫度，則補償電壓可通過下面公式計算：

$$V_{boost_comp} = 28.8V - 5mV * (TEMP_bat - 25°C) * 12Cell$$

$$\text{補償上限: } V_{boost_H} = 28.8V - 5mV * (0°C - 25°C) * 12Cell = 30.3V$$

$$\text{補償下限: } V_{boost_L} = 28.8V - 5mV * (40°C - 25°C) * 12Cell = 27.9V$$

5.9 過功率模式

5.9.1 電池未接入

電源在115%額定功率條件下，可維持5秒正常輸出，5秒後關機。

5.9.2 電池已接入

負載最大電流為額定電流2倍時，此狀態持續時間最長4分鐘；

負載最大電流為額定電流3倍時，此狀態持續時間最長4秒種；

以48V機型為例

◎ 負載最大電流為額定電流2倍時，此狀態持續時間最長4min；

負載最大電流為額定電流3倍時，此狀態持續時間最長4s。

輸出負載



- ◎ 以每10min時長計數，2倍總時長不超過6min,3倍總時長不超過6s。如超出此時間，DRS自動關機保護。

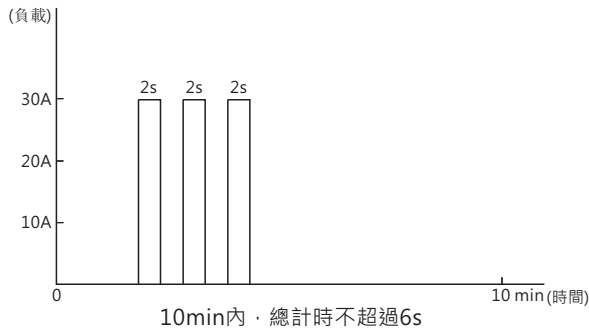
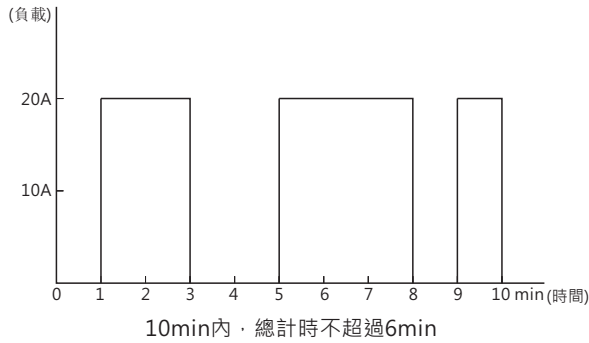

5.10 恢復出廠設置

使用者可依循下述動作將機器之設定參數(命令0x0000、0x0020、0x0030、0x00B0~0x00B7、0x00C2、0x00E0~0x00E4)恢復至出廠設定值：

- (1) AC投入15秒內，短按5次Bat_start按鈕。
- (2) 綠色LED (狀態燈) 閃爍3次表示設定成功。
- (3) 重新開機後將恢復原廠設定。

6. 保護功能及異常排除

6.1 保護功能

6.1.1 輸出過載保護

當輸出過載時，電源以恆定電流方式限制輸出，並於5s後關機保護。需重新啟動方能使電源恢復正常工作狀態。

6.1.2 過溫度保護

當電源內部溫度過高時，電源關閉輸出，溫度恢復正常後，電源自動恢復輸出。

充電模式狀態下，當電源內部溫度過高時，電源依減額曲線(參考2.5章節)自動降載，若溫度仍過高且超過閾值，電源關閉輸出，溫度恢復正常後，電源自動恢復輸出。

6.1.3 輸出過電壓保護

輸出端電壓過高達到電源OVP保護點時，電源關斷輸出，需重新啟動方能使電源恢復正常工作狀態。

6.1.4 電池電壓過低保護

當電池電壓過低時，電源關斷輸出。

機型	電池關斷電壓
12V	10.5 ±0.3V
24V	20.9 ±0.5V
36V	31.3 ±0.7V
48V	41.8 ±1.0V

6.1.5 反極性保護

通過內部MOSFET防反接，異常狀態移除後可自動恢復，電源不會損壞。

6.2 異常排除

狀態	可能原因	排除方法
電池備援功能失效	電池未連接、 電池電壓低	確認接線良好、確認電池規格 是否匹配、更換電池
無法強制啟動	按鈕：電池電壓低/ 反接	檢查電池接線或更換電池
	CN12: 接線不良	檢查CN12 PIN7&8接線正確 並良好
AC供電正常情 況下，自動關機	電池放電峰值功率 超時 (LED 狀態燈 連續閃紅燈4次)	確認負載並重新開機
	過溫保護 (LED 狀 態燈連續閃紅燈 6次)	溫度降低後重新開機
	過電壓保護 (LED 狀態燈連續閃紅燈 2次)	確認電池規格是否匹配
	短路保護 (LED 狀 態燈連續閃紅燈5 次)	排查短路故障後重新開機
電池長時間充電仍 無法充飽	電池已老化或損壞	更換新電池
	輸出線材線徑太細	選擇適當線徑之線材
	充電曲線設定錯誤	重新確認電池充電曲線

注：1. 更多LED燈號異常狀態可參考4.3章節。

2. 若仍無法排除故障情形，請洽明緯或明緯經銷商

7.保固

本產品符合規格條件下，可提供3年之無償免費維修服務。請勿自行更換零件或對本產品進行任何形式 修 或維修，以免影響您享有正常保固服務之權利。

※明緯保有修訂使用手冊之權利，若有修訂，請以明緯官網
資訊為準。 <https://www.meanwell.com>



明緯企業股份有限公司

MEAN WELL ENTERPRISES CO., LTD.

248 新北市五股區五權三路28號

No.28, Wuquan 3rd Rd., Wugu Dist., New Taipei City 248, Taiwan

Tel: 886-2-2299-6100 Fax: 886-2-2299-6200

<http://www.meanwell.com> E-mail: info@meanwell.com