

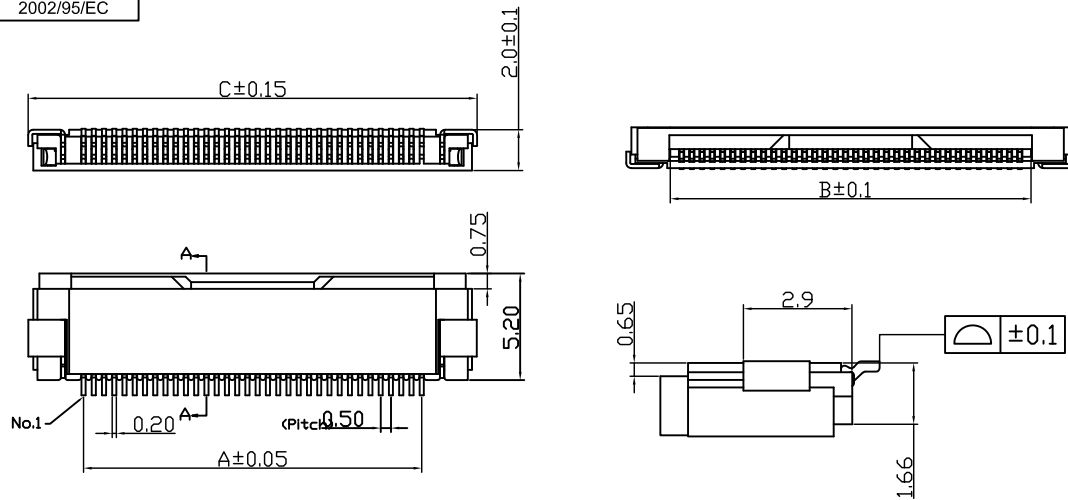

RoHS Compliant
2002/95/EC



How to order

Z56-*nn*-C P T

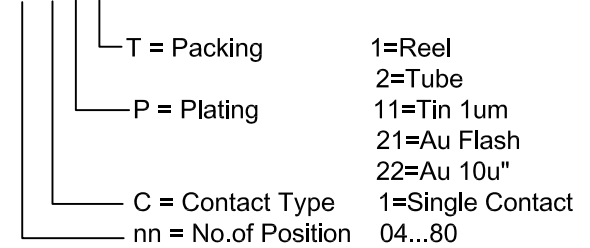

Dimensions

A = (n*0,5) -0,5
B = (n*0,5) +0,6
C = (n*0,5) +4,9
n = No. of Circuits

Applicable FFC/FPC

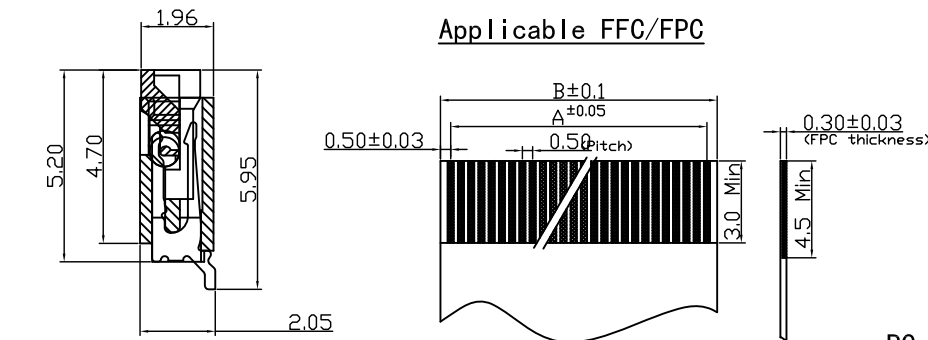

PC Board Layout

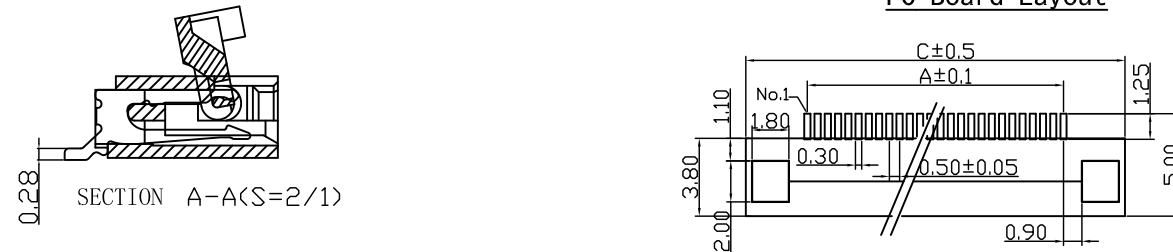

Technical Parameter

Pitch: 0.5mm
Current rating: 0.5A AC,DC
Voltage rating: 50V AC,DC
Temperature range: -40°C ~ +85°C
Withstand Voltage: 200V/min
Contact resistance: ≤0.03Ω
Insulation resistance: ≥500MΩ
Retention Force: ≥0,4N initial

Drawing Number:
Z56-XX
Ref. Number:
ZIF 0,5mm Lower Contact



Item	Part Name	Material	Surface Plating	Others	Date	Modification	Contents	Revise Doc. Num.	Checked	Approval	Tolerance	Unit : MM
1	Housing	LCP		UL94V-0							Dimensions	Angle Scale: 1:1 Page: 1/2
2	Terminal	Phosphor Bronze	Ni ≥ 0.5 μm Sn/Cu ≥ 1.0 μm								X. =0.3 X.X =0.25 X.XX=0.08	
3	Solder Pad	Phosphor Bronze	Ni ≥ 0.5 μm Sn/Cu ≥ 1.0 μm									
4	Locking	PPS		UL94V-0							R00-2015-01-20	



RoHS Compliant
2002/95/EC

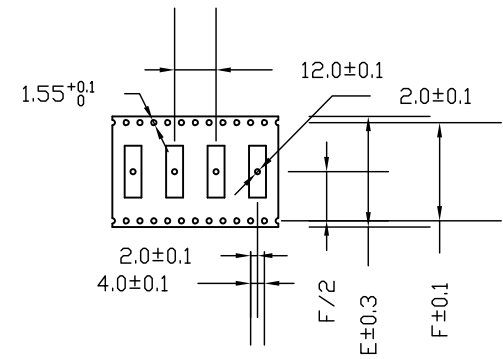
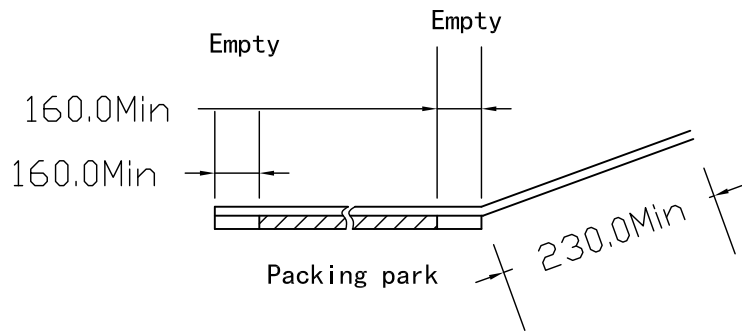
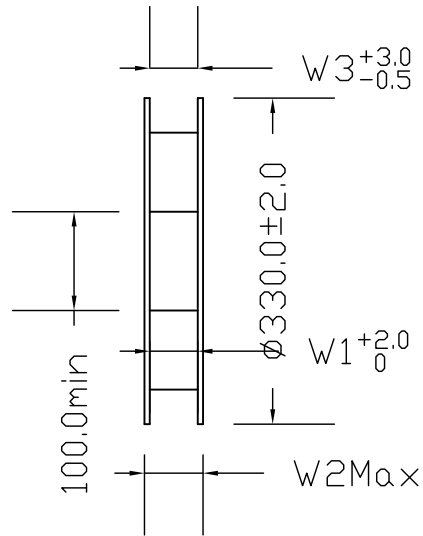
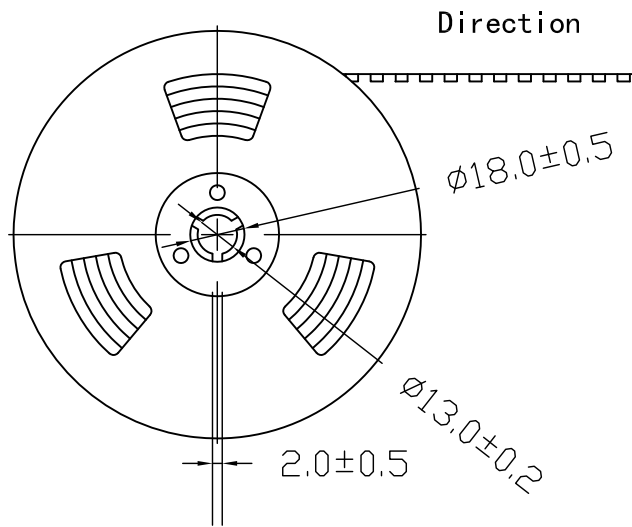

Belt Wide: 32, 44, 56MM

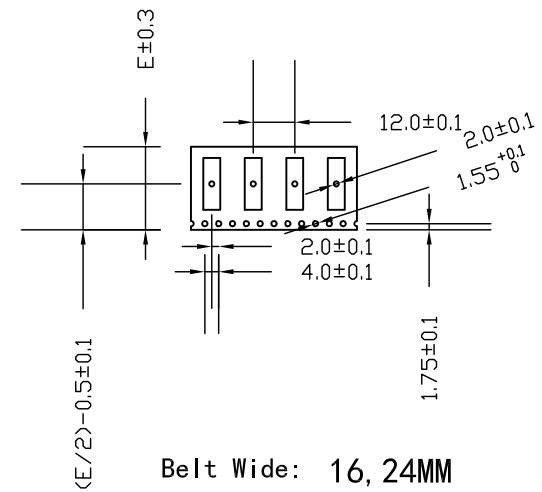

Belt Wide: 16, 24MM

Pins	Dimensions				
	E	F	W1	W2	W3
4~10	16.0		16.5	22.5	16.5
11~20	24.0		24.5	30.5	24.5
21~32	32.0	28.4	32.5	38.5	32.5
33~50	44.0	40.4	44.5	50.5	44.5
51~61	56.0	52.4	56.5	62.5	56.5

Belt Base:		PS ; Black		Drawing Number:			 ElectronAix GmbH Co. KG	
Belt Cover:		TPE ;Transparent		Z56-XX				
Quantity :		2,000 Pcs/Reel		Ref. Number: ZIF 0,5mm Lower Contact				
Date	Modification	Contents		Revise Doc. Num.	Checked	Approval	Tolerance	Unit : MM
							Dimensions Angle	 Scale: 1:1 Page: 2/2
							X. =0.3 X.X =0.25 X.XX=0.1	
							0.3°	
R00-2015-01-20								

Spezifikation Z56-xx Series
ZIF FFC/FPC Connector 0,5mm Pitch Double Contact H1,96mm Piano

1 Scope

This Specification covers the construction and characteristics of 0,5mm Pitch FFC and FPC (Flat Flexible Cable and Flat PCB Cable) of Z56-xx ZIF Connector Series. The part shall satisfy the following performance

2 Material and Plating

Item	Material	Plating	Remark
Terminal	Phosphor Bronze C5191R-H	Ni \geq 0,5 μ m SN \geq 1,0 μ m	ROHS REACH
Solder Pad	Phosphor Bronze C5191R-H	Ni \geq 0,5 μ m SN \geq 1,0 μ m	ROHS REACH
Base/Housing	LCP	Color: Nature	ROHS REACH UL94V-0
Lock	PPS	Color: Brown	ROHS REACH UL94V-0

3 Environmental

The products meet EU RoHS Directive 2011/65/eu
The products meet EU REACH Directive 1907/2006/EU

4 Technical Parameter

Item	Specification
Voltage Rating	50V AC/DC
Current rating	0,5A AC/DC
Temperature Range	-40°C ... +85°C
Voltage Withstand	200V / Min.
Contact Resistance	\leq 0,03 Ω
Insulation Resistance	\geq 500M Ω

Spezifikation Z56-xx Series
ZIF FFC/FPC Connector 0,5mm Pitch Double Contact H1,96mm Piano

5 Performance

5.1 Electrical Performance

Item	Requirement	Testing Method
Contact Resistance	$\leq 0,03 \Omega$ Initial	Connecting the mated connector to a closed circuit of current 10mA and max. 20mV
Insulation Resistance	$\geq 500M \Omega$	Checking the resistance between terminals & terminals with grounding. MIL-STD-202, Method 302, Condition B (500V DC \pm 10%)
Dielectric Strength	Connector must withstand the test of 200V AC for 1minute and current leakage must be 0.5mA maximum.	Checking the dielectric strength between terminals & terminals with grounding. MIL-STD-202, Method 301.

5.2 Mechanical Performance

Item	Requirement	Testing Method
FFC/FPC Retention Force	$\geq 0,4N/Pcs$ initial $\geq 0,3N/Pcs$ 10 Times	Withdraw FPC from the locked connector with a speed of 25 \pm 3 mm/minute
Contact Retention Force	$\geq 0,3N/Pcs$	pull out the terminal from connector base with a speed of 25 \pm 3 mm/minute.
Solderability	Appearance of the specimen shall be inspected after the test with the assistance of a 10X magnifier. No damage such as pinholes, void or rough surface should be found.	Reflow: 2 Cycles 250°C 5 Sec. Wave: 1 Cycle 250°C 5 Sec.
Resistance to Soldering Heat	No damage	255 \pm 5°C chamber for 10 \pm 0.5Seconds

5.3 Environmental Performance

Item	Requirement	Testing Method
Temperature rise	No damage, Contact Resistance $\leq 0.03\Omega$	Temperature range from -40°C to +85°C 3 Minute per cycles. Total 5 cycles.
High temperature	No damage, Contact Resistance $\leq 0.03\Omega$	Subject product to 85 \pm 2°C for 96 hours continuously. MIL-STD-202, Method 108
Low temperature	No damage, Contact Resistance $\leq 0.03\Omega$	Subject product to -40 \pm 2°C for 96 hours continuously. MIL-STD-202, Method 108
Humidity	No Damage, Contact Resistance $\leq 0.03\Omega$ Insulation Resistance $\geq 500 M\Omega$	Temperature:40 \pm 2°C 96 hours. Relative Humidity:90-95% MIL-STD-202, Method 103
Salt Spray	Surface: No serious oxidation Contact Resistance $\leq 0.03\Omega$	5 \pm 1% salt solution 48 \pm 4 hours 35 \pm 2°C MIL-STD-202, Meth.101 Cond. B
Flammability	Material conform to UL94V-0	Vertical burning method

Spezifikation Z56-xx Series
ZIF FFC/FPC Connector 0,5mm Pitch Double Contact H1,96mm Piano

6 Marking, Packing, Transportation, Store

6.1 Logo

Connector had stamped production line logo: LW

6.2 Packing

Inner packing with Plastic Tube or Tape & Reel.

Outer with a carton box.

No shaking.

6.3 Transportation

Allow using any transportation, but cannot expose under rain, snow, and machinery injury.

6.4 Store

Finished goods should be kept in a well store environment.

Temperature: $-10^{\circ}\text{C} \sim +40^{\circ}\text{C}$; Humidity maximum 80%

No acidity, alkalinity, corrosiveness gas are allow within the store.

Storage period is 24 month, if over 24 month has to reexamine.

7 Infrared Reflow Condition

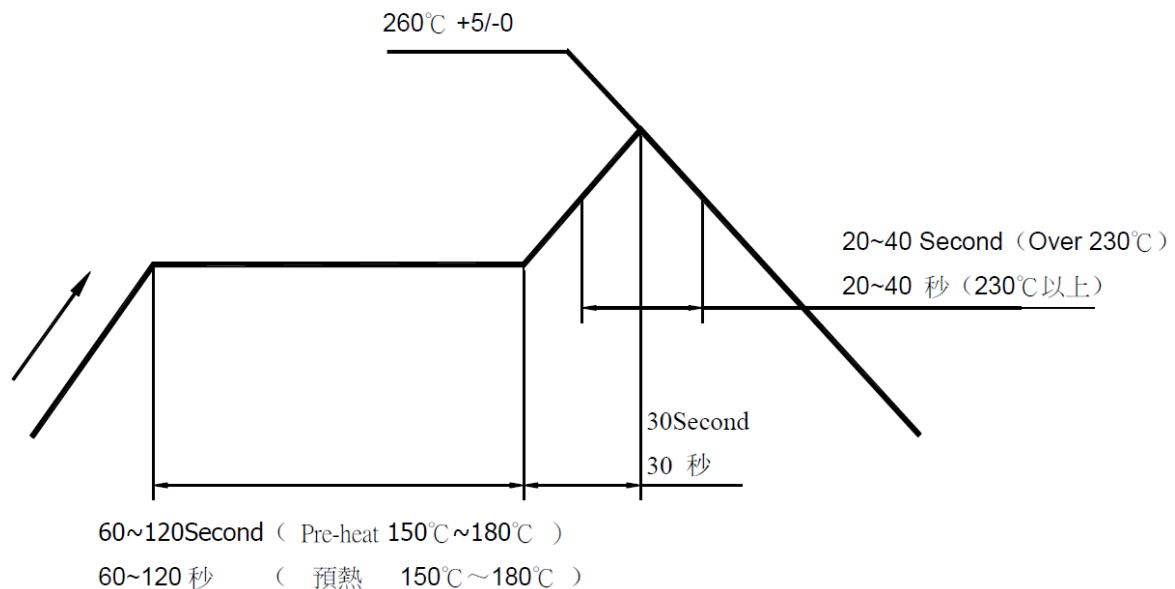

Spezifikation Z56-xx Series
ZIF FFC/FPC Connector 0,5mm Pitch Double Contact H1,96mm Piano

8 How to Order

Zxy-nn-CPTO	
	O = Option
T = Packing	1 = Reel 2 = Tube
P = Plating	11 = Tin 1um 21 = Au Gold Flash 24 = Au 10u“
C = Contact Type	1 = single contact 2 = double contact
nn = No. of Positions	04 ... 80
y = mating style	1 = upper contact 2 = lower contact 3 = vertical Type A / 4 = vertical Type B\ 5 = Easylock H1,56mm Double Contact 6 = Easylock H1,96mm High Retention 7 = Easylock H1,20mm Low Profile
Zx = Series	Z1 = ZIF FFC / FPC 1,0mm Pitch Z5 = ZIF FFC / FPC 0,5mm Pitch Z3 = ZIF FFC / FPC 0,3mm Pitch Lx = LIF FFC / FPC 0,3mm Pitch