

KEMET Part Number: R82DC3100DQ50K
(82DC3100DQ50K)

Capacitor, film, 0.1 uF, +/-10% Tol, -55/+105C, General Purpose, 63V@85C, Lead Spacing=5 mm

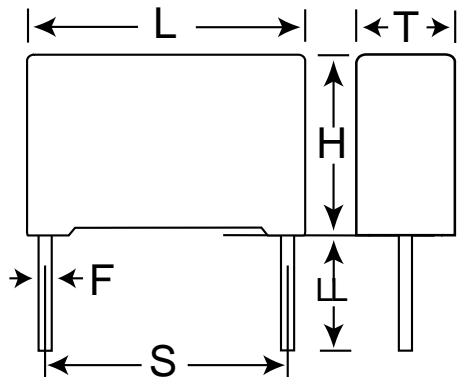

Dimensions (mm)		
Symbol	Dimension	Tolerance
L	7.2	+0.2
H	6.5	+0.1
T	2.5	+0.1
S	5	+/-0.4
LL	18.5	+/-0.5
F	0.5	+/-0.05

Notes:

-L,H,T are nominal dimensions and do not imply a minimum.

General Information

Supplier:	KEMET
Brand:	Arcotronics
Miscellaneous Electrical:	Not for new design. Use F612JF104K063R (series F612)

Specifications

Capacitance:	0.1 uF
Rated Temperature:	85C
Voltage @ rated temp:	63V
Voltage AC:	40VAC
Tolerance:	+/-10%
Body Type:	Radial Box
Dielectric:	Metallized Polyester (Stacked)
Application:	General Purpose
Temperature Range:	-55/+105C
Dissipation Factor @ 1 kHz:	0.8%
Dissipation Factor @ 10 kHz:	1.2%
Insulation Resistance:	15 GOhm
Inductance:	7 nH
Maximum dVdT:	160v/us
Maximum K0:	20000V^2/us

Packaging Specifications

Package Kind:	Ammo
Package Size:	360x340x59mm
Package Type:	Box
Package Quantity:	3500