

Capacitor, aluminum, 47 uF, +/-20% Tol, -40/+85C, 50V@85C

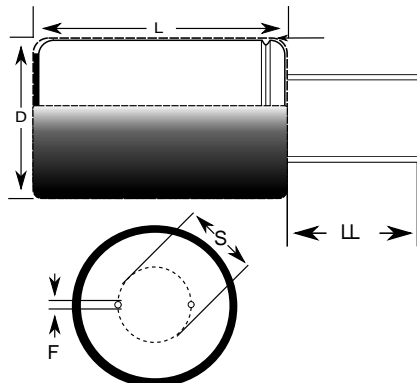

Dimensions (mm)		
Symbol	Dimension	Tolerance
D	6	+0.8/-0.5
L	11	+1.5
S	2.5	+/-0.5
LL	18.5	
F	0.5	

Packaging Specifications	
Package Kind:	Ammo
Package Quantity:	2000

General Information	
Supplier:	KEMET
Part Type Description:	Radial Cylindrical Aluminum Electrolytic
Style:	Radial Cylindrical
Lead Type:	Straight

Specifications	
Capacitance:	47 uF
Tolerance:	+/-20%
Rated Temperature:	85C
Voltage @ rated temp:	50V
VDC Surge:	63WVDC
Life @ rated temp:	2000 h
RoHS:	Yes
Temperature Range:	-40/+85C
Leakage Condition:	2min/20c
Dissipation Factor:	10%
Ripple 120Hz @ rated temp:	0.14 A