

Capacitor, film, 0.15 uF, +/-20% Tol, -40/+110C, Safety: X2, 275VAC, Lead Spacing=15 mm

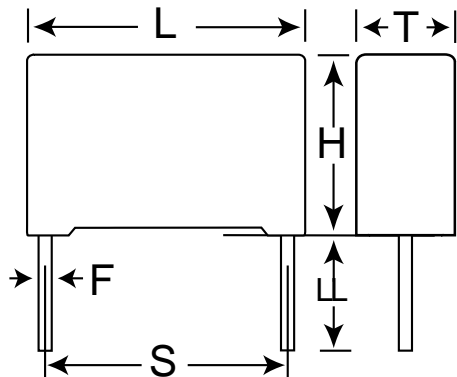

Dimensions (mm)		
Symbol	Dimension	Tolerance
L	18	+0.3
H	12	+0.1
T	6	+0.2
S	15	
LL	4	+2/-0
F	0.6	+/-0.05

Notes:

-L,H,T are nominal dimensions and do not imply a minimum.

General Information

Supplier: KEMET

Specifications

Capacitance:	0.15 uF
Rated Temperature:	110° C
Voltage @ rated temp:	560VDC
Voltage AC:	275VAC
Tolerance:	+/-20%
Body Type:	Radial Box
Dielectric:	Metallized Polypropylene
Application:	Safety: X2
Temperature Range:	-40/+110C
Dissipation Factor @ 1 kHz:	0.1%
Insulation Resistance:	100 MOhm
Maximum dVdT:	400v/us

Agency Approvals

Approvals: ENEC,UL,cUL,CQC

Packaging Specifications

Package Kind:	Bulk
Package Quantity:	1750