



Features

- Full power at 65~100% operation(Constant Power)
- Protection Functions: OCP,SCP,OVP,OTP
- IP67 design for indoor or outdoor installations
- Function options: output adjustable via potentiometer; 3 in 1 dimming (dim-to-off) ; DALI-2 dimming
- Typical lifetime>50000 hours and 5 years warranty
- Surge protection with 6KV/4KV
- Latest safety requirements of IEC61347/GB19510 and UL8750

Applications

- LED bay lighting
- LED stage lighting
- LED flood lighting
- LED fishing lighting
- LED horticulture lighting
- Stadium lighting
- Type “HL” for use in class I , Division 2

Description

GTIN CODE

MW Search: <https://www.meanwell.com/serviceGTIN.aspx>

ELGC-300 series is a 300W LED AC/DC driver featuring the constant power mode and high voltage output. ELGC-300 operates from 100~305VAC and offers models with different rated current ranging between 1300mA and 8000mA. Thanks to the high efficiency up to 94.5%, with the fanless design, the entire series is able to operate for -40°C~+85°C case temperature under free air convection. The design of metal housing and IP67 ingress protection level allows this series to fit both indoor and outdoor applications. Moreover the innovative environment-adaptive capability allows this series to reliably light on the LEDs for all kinds of application environments in almost any spots that may install LED luminaires in the world. ELGC-300 is equipped with various function options, such as dimming methodologies, so as to provide the optimal design flexibility for LED lighting system.

Model Encoding

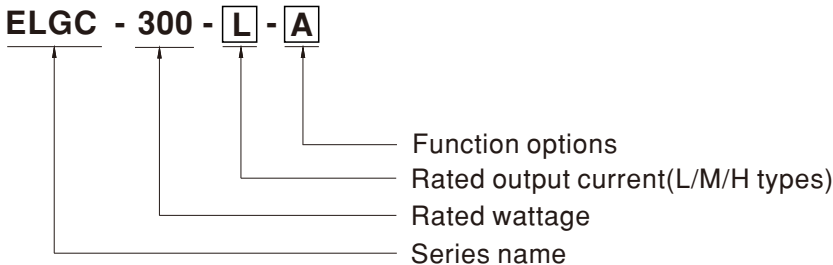

Type	IP Level	Function	Note
Blank	IP67	Blank type available by modification	By request
A	IP67	Output constant power adjustable via built-in lo potentiometer	In Stock
AB	IP67	Output constant power adjustable via built-in lo potentiometer + 3 in 1 dimming function (0~10Vdc, 10V PWM signal and resistance)	In Stock
ADA	IP67	DALI-2 control technology with lo Adjustable via built-in Potentiometer	In Stock
D2	IP67	Built-in Smart timer dimming and programmable function.	By request

SPECIFICATION

MODEL		ELGC-300-L-□	ELGC-300-M-□	ELGC-300-H-□	
OUTPUT	DEFAULT CURRENT	1400mA	2800mA	5600mA	
	RATED POWER	(200 ~ 305VAC)	301W	301W	301
		(100 ~ 180VAC)	256W	256W	256W
	CONSTANT CURRENT REGION	116 ~ 232V	58 ~ 116V	29 ~ 58V	
	FULL POWER CURRENT RANGE	1300~2000mA	2600~4000mA	5200~8000mA	
	OPEN CIRCUIT VOLTAGE (max.)	240V	120V	62V	
	CURRENT ADJ. RANGE	(200 ~ 305VAC)	650~2000mA	1300~4000mA	2600~8000mA
		(100 ~ 180VAC)	650~1700mA	1300~3400mA	2600~6800mA
	CURRENT RIPPLE	5.0% max. @rated current			
CURRENT TOLERANCE	± 5%				
SET UP TIME	Note.9	500ms/230VAC, 500ms/115VAC			
INPUT	VOLTAGE RANGE	Note.2	100 ~ 305VAC 142VDC ~ 431VDC (Please refer to "STATIC CHARACTERISTIC" and "DRIVING METHODS OF LED MODULE" section)		
	FREQUENCY RANGE	47 ~ 63Hz			
	POWER FACTOR (Typ.)	PF ≥ 0.97 / 115VAC, PF ≥ 0.95 / 230VAC, PF ≥ 0.92 / 277VAC at full load (Please refer to "Power Factor Characteristic" section)			
	TOTAL HARMONIC DISTORTION	THD < 10% (@ load ≥ 50% at 115VAC/230VAC, @load ≥ 75% at 277VAC) Please refer to "TOTAL HARMONIC DISTORTION (THD)" section			
	EFFICIENCY (Typ.)	94.5%	93.5%	92.5%	
	AC CURRENT (Typ.)	3A / 115VAC	1.6A / 230VAC	1.3A / 277VAC	
	INRUSH CURRENT(Typ.)	COLD START 45A(twidth=1200μs measured at 50% I _{peak}) at 230VAC; Per NEMA 410			
	MAX. NO. of PSUs on 16A CIRCUIT BREAKER	2 unit(circuit breaker of type B) / 4 units(circuit breaker of type C) at 230VAC			
	LEAKAGE CURRENT	<0.75mA / 277VAC			
STANDBY POWER CONSUMPTION	Note.5	Standby power consumption <0.5W for AB / ADA-Type(Dimming OFF)			
PROTECTION	SHORT CIRCUIT	Constant current limiting, recovers automatically after fault condition is removed			
	OVER VOLTAGE	241 ~ 275V	121 ~ 145V	61 ~ 78V	
		Shut down output voltage, re-power on to recovery			
OVER TEMPERATURE	T _{case} > 85°C ± 5°C, derate power automatically by 6%/°C max				
ENVIRONMENT	WORKING TEMP.	T _{case} = -40 ~ +85°C (Please refer to "OUTPUT LOAD vs TEMPERATURE" section)			
	MAX. CASE TEMP.	T _{case} = +85°C			
	WORKING HUMIDITY	20 ~ 95% RH non-condensing			
	STORAGE TEMP., HUMIDITY	-40 ~ +80°C, 10 ~ 95% RH non-condensing			
	TEMP. COEFFICIENT	± 0.03%/°C (0 ~ 60°C)			
	VIBRATION	10 ~ 500Hz, 5G 12min./1cycle, period for 72min. each along X, Y, Z axes			
SAFETY & EMC	SAFETY STANDARDS	UL8750(type "HL"), CSA C22.2 No. 250.13-12; ENEC BS EN/EN61347-1, BS EN/EN61347-2-13 independent, BS EN/EN62384; EAC TP TC 004; GB19510.1, GB19510.14; IP67; KC61347-1, KC61347-2-13 approved			
	DALI STANDARDS	Compliance to IEC62386-101,102,207 for ADA Type only			
	WITHSTAND VOLTAGE	I/P-O/P:3.75KVAC I/P-FG:2KVAC O/P-FG:1.5KVAC			
	ISOLATION RESISTANCE	I/P-O/P, I/P-FG, O/P-FG:100M Ohms / 500VDC / 25°C / 70% RH			
	EMC EMISSION	Compliance to BS EN/EN55015, BS EN/EN61000-3-2 Class C (@ load ≥ 50%); BS EN/EN61000-3-3; KN15			
EMC IMMUNITY	Compliance to BS EN/EN61000-4-2,3,4,5,6,8,11, BS EN/EN61547, light industry level (surge immunity Line-Earth 6KV, Line-Line 4KV); KN61547				
OTHERS	MTBF	1637.5K hrs min.	Telcordia SR-332 (Bellcore); 170.1K hrs min.	MIL-HDBK-217F (25°C)	
	LIFETIME	Note.4	50000 hrs min.		
	DIMENSION	246*77*39.5mm (L*W*H)			
	PACKING	1.45Kg; 9pcs/14Kg/0.76CUFT			
NOTE	<p>1. All parameters NOT specially mentioned are measured at 230VAC input, rated current and 25°C of ambient temperature.</p> <p>2. De-rating may be needed under low input voltages. Please refer to "STATIC CHARACTERISTIC" sections for details.</p> <p>3. The driver is considered as a component that will be operated in combination with final equipment. Since EMC performance will be affected by the complete installation, the final equipment manufacturers must re-qualify EMC Directive on the complete installation again.</p> <p>4. This series meets the typical life expectancy >50,000 hours of operation when T_{case}, particularly (C) point (or T_{MP}, per DLC), is 70°C or less.</p> <p>5. To fulfill requirements of the latest ErP regulation for lighting fixture, this LED driver can only be used behind a switch without permanently connected to the mains.</p> <p>6. Please refer to the warranty statement on MEAN WELL's website at http://www.meanwell.com</p> <p>7. The ambient temperature derating of 3.5°C/1000m with fanless models and of 5°C/1000m with fan models for operating altitude higher than 2000m(6500ft).</p> <p>8. For any application note and IP water proof function installation caution, please refer our user manual before using. https://www.meanwell.com/Upload/PDF/LED_EN.pdf</p> <p>9. Based on IEC 62386-101/102 DALI power on timing and interruption regulations, the set up time needs to test with a DALI controller which can support for DALI power on function, otherwise the set up time will be higher than 0.5 second for DA type.</p> <p>10. Products sourced from the Americas regions may not have the ENEC/BIS/CCC/KC logo. Please contact your MEAN WELL sales for more information.</p> <p>※ Product Liability Disclaimer : For detailed information, please refer to https://www.meanwell.com/serviceDisclaimer.aspx</p>				

BLOCK DIAGRAM

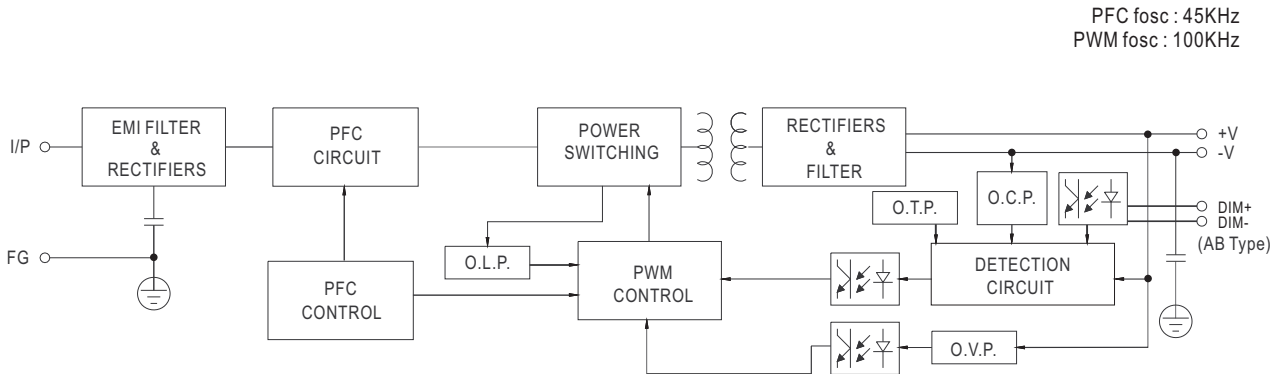

DRIVING METHODS OF LED MODULE

※ I-V Operating Area:(Red Line for AC 115V operation)

◎ ELGC-300-L

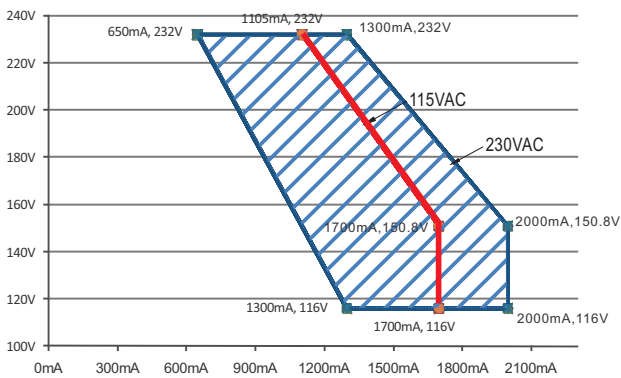

◎ ELGC-300-M

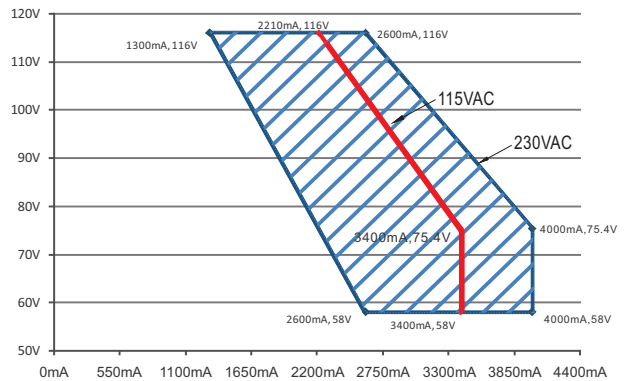

◎ ELGC-300-H

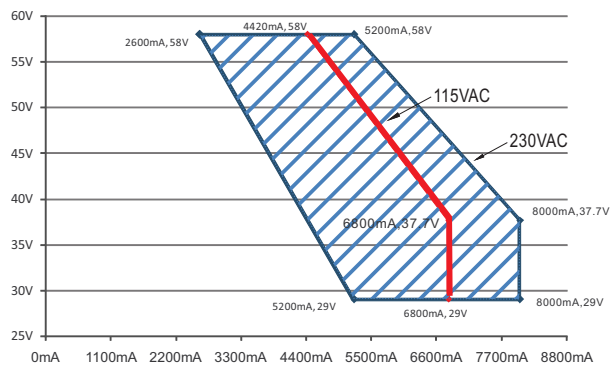

DIMMING OPERATION

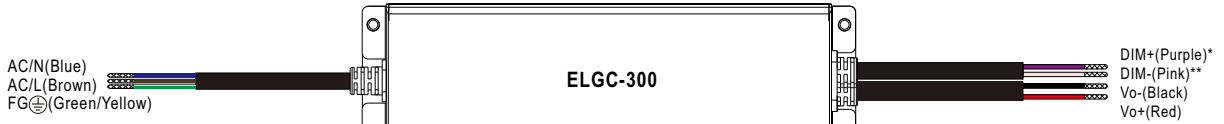

* DIM+ for AB Type
 DA+ for ADA Type
 PROG+ for D2 Type
 ** DIM- for AB Type
 DA- for ADA Type
 PROG- for D2 Type

※ **3 in 1 dimming function (for AB-Type)**

- Output constant current level can be adjusted by applying one of the three methodologies between DIM+ and DIM-: 0 ~ 10VDC, or 10V PWM signal or resistance.
- Direct connecting to LEDs is suggested. It is not suitable to be used with additional drivers.
- Dimming source current from power supply: 100 μ A (typ.)

◎ Applying additive 0 ~ 10VDC

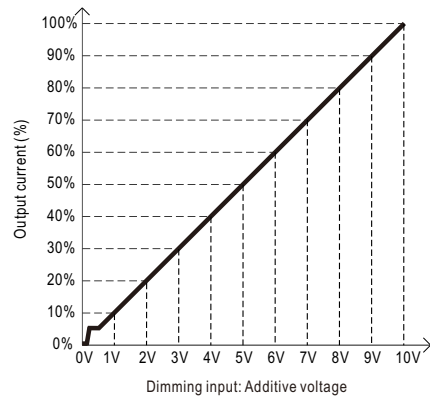
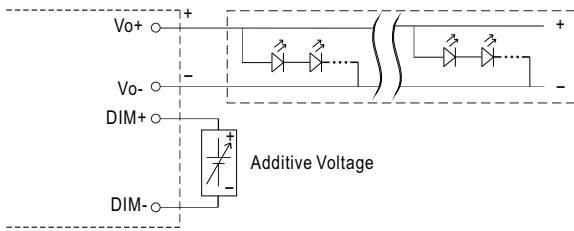

◎ Applying additive 10V PWM signal (frequency range 100Hz ~ 3KHz):

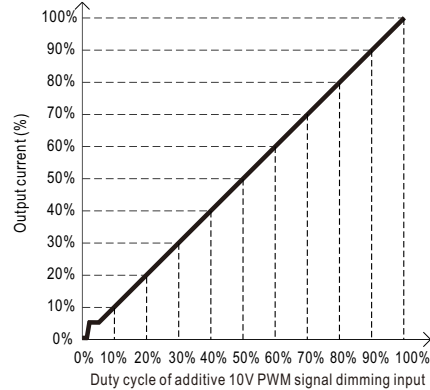
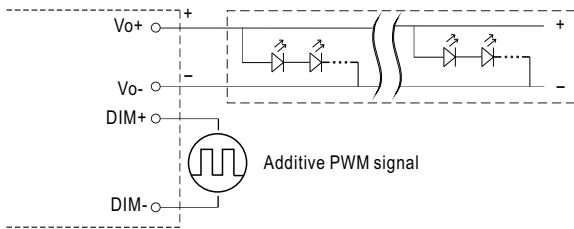

◎ Applying additive resistance:

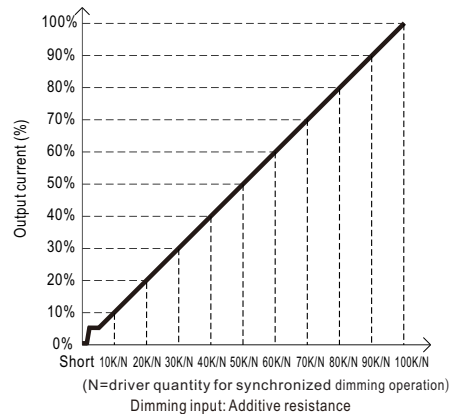
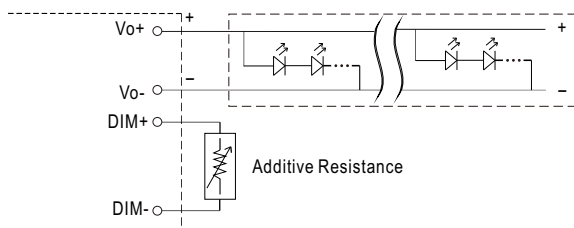

Note : 1. Min. dimming level is about 8% and the output current is not defined when 0% < I_{out} < 8%.
 2. The output current could drop down to 0% when dimming input is about 0 Ω or 0Vdc, or 10V PWM signal with 0% duty cycle.

※ **DALI Interface (primary side; for ADA-Type)**

- Apply DALI signal between DA+ and DA-.
- DALI protocol comprises 16 groups and 64 addresses.
- First step is fixed at 8% of output.

※ **Smart timer dimming function (for Dxx-Type by User definition)**

MEAN WELL Smart timer dimming primarily provides the adaptive proportion dimming profile for the output constant current level to perform up to 14 consecutive hours. 3 dimming profiles hereunder are defined accounting for the most frequently seen applications. If other options may be needed, please contact MEAN WELL for details.

Ex : ☉ D01-Type: the profile recommended for residential lighting

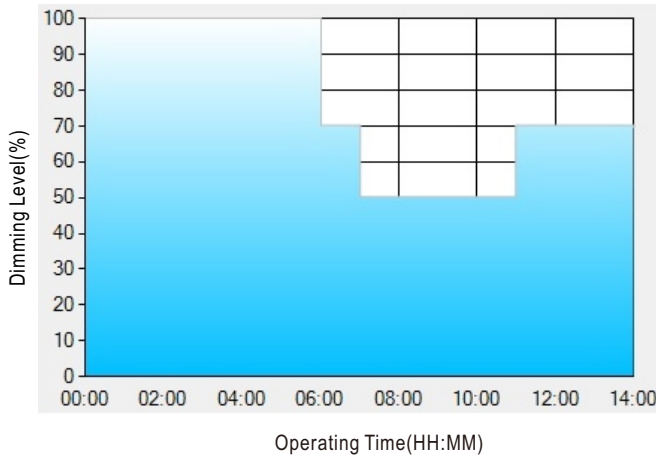

Set up for D01-Type in Smart timer dimming software program:

	T1	T2	T3	T4
TIME**	06:00	07:00	11:00	---
LEVEL**	100%	70%	50%	70%

** : TIME matches Operating Time in the diagram whereas LEVEL matches Dimming Level.

Example: If a residential lighting application adopts D01-Type, when turning on the power supply at 6:00pm, for instance:

- [1] The power supply will switch to the constant current level at 100% starting from 6:00pm.
- [2] The power supply will switch to the constant current level at 70% in turn, starting from 0:00am, which is 06:00 after the power supply turns on.
- [3] The power supply will switch to the constant current level at 50% in turn, starting from 1:00am, which is 07:00 after the power supply turns on.
- [4] The power supply will switch to the constant current level at 70% in turn, starting from 5:00am, which is 11:00 after the power supply turns on.

The constant current level remains till 8:00am, which is 14:00 after the power supply turns on.

Ex : ☉ D02-Type: the profile recommended for street lighting

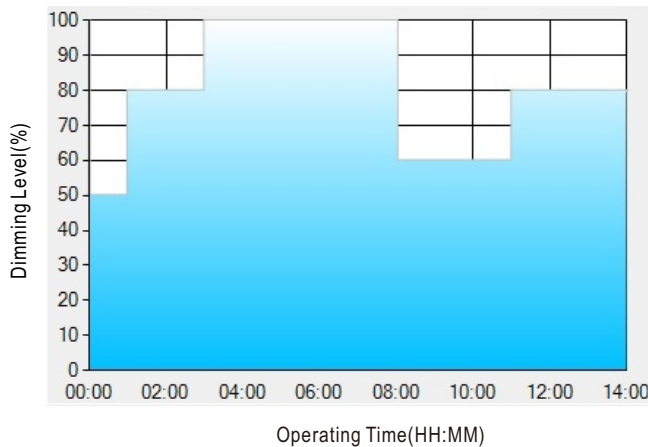

Set up for D02-Type in Smart timer dimming software program:

	T1	T2	T3	T4	T5
TIME**	01:00	03:00	8:00	11:00	---
LEVEL**	50%	80%	100%	60%	80%

** : TIME matches Operating Time in the diagram whereas LEVEL matches Dimming Level.

Example: If a street lighting application adopts D02-Type, when turning on the power supply at 5:00pm, for instance:

- [1] The power supply will switch to the constant current level at 50% starting from 5:00pm.
- [2] The power supply will switch to the constant current level at 80% in turn, starting from 6:00pm, which is 01:00 after the power supply turns on.
- [3] The power supply will switch to the constant current level at 100% in turn, starting from 8:00pm, which is 03:00 after the power supply turns on.
- [4] The power supply will switch to the constant current level at 60% in turn, starting from 1:00am, which is 08:00 after the power supply turns on.
- [5] The power supply will switch to the constant current level at 80% in turn, starting from 4:00am, which is 11:00 after the power supply turns on. The constant current level remains till 6:30am, which is 14:00 after the power supply turns on.

Ex: ☉ D03-Type: the profile recommended for tunnel lighting

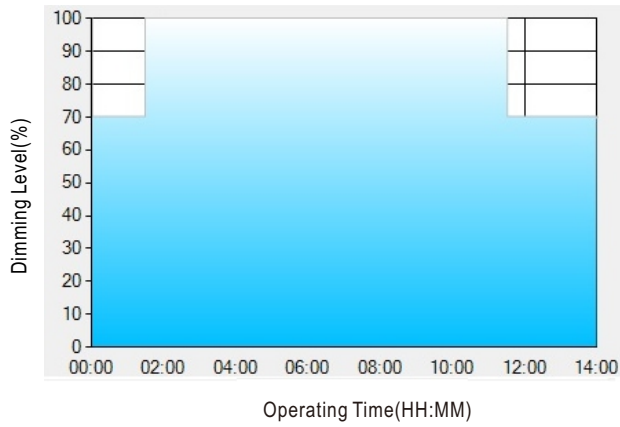

Set up for D03-Type in Smart timer dimming software program:

	T1	T2	T3
TIME**	01:30	11:00	---
LEVEL**	70%	100%	70%

** : TIME matches Operating Time in the diagram whereas LEVEL matches Dimming Level.

Example: If a tunnel lighting application adopts D03-Type, when turning on the power supply at 4:30pm, for instance:

[1] The power supply will switch to the constant current level at 70% starting from 4:30pm.

[2] The power supply will switch to the constant current level at 100% in turn, starting from 6:00pm, which is 01:30 after the power supply turns on.

[3] The power supply will switch to the constant current level at 70% in turn, starting from 5:00am, which is 11:00 after the power supply turns on.

The constant current level remains till 6:30am, which is 14:00 after the power supply turns on.

OUTPUT LOAD vs TEMPERATURE

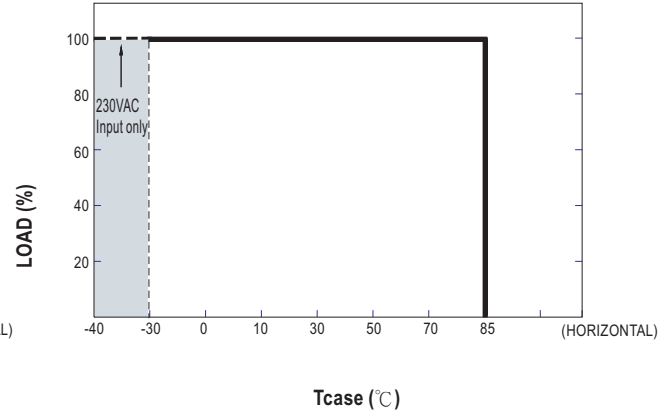
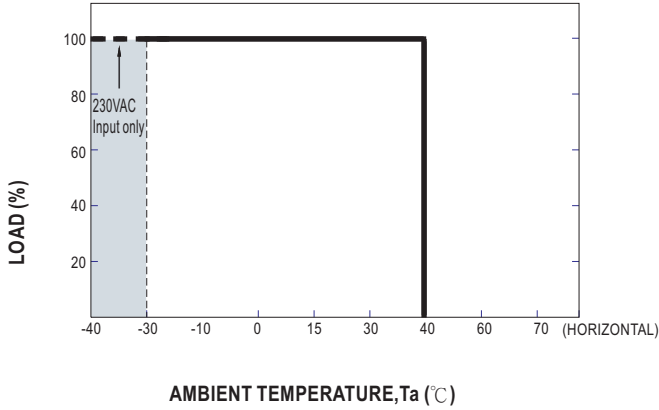

⊙ Tcase > 85°C ± 5°C derate power automatically

STATIC CHARACTERISTIC

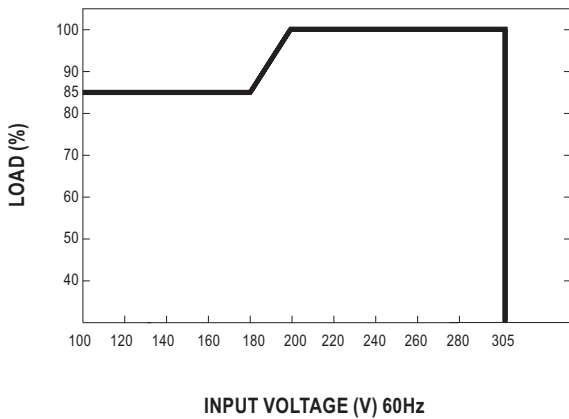

POWER FACTOR (PF) CHARACTERISTIC

※ Tcase at 75°C

Constant Current Mode

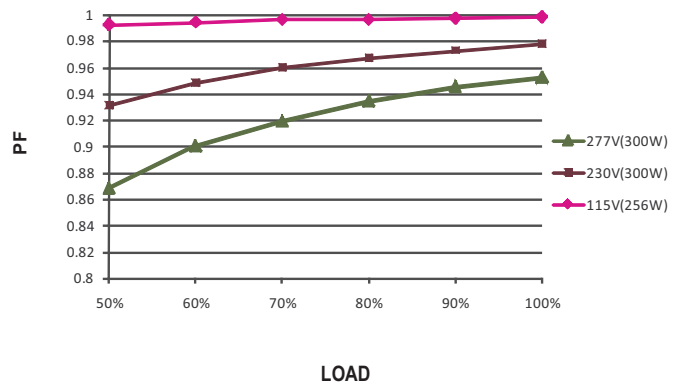

TOTAL HARMONIC DISTORTION (THD)

※ ELGC-300-L Model, Tcase at 75°C

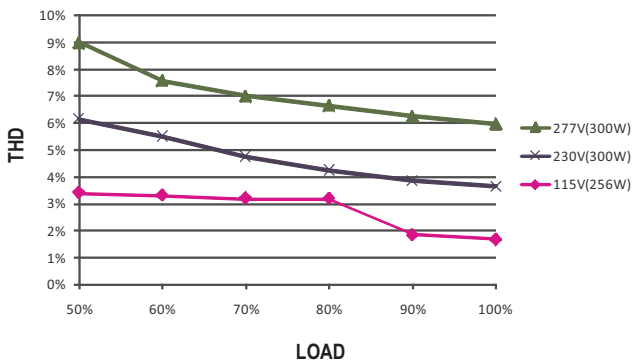

EFFICIENCY vs LOAD

ELGC-300 series possess superior working efficiency that up to 94.5% can be reached in field applications.

※ ELGC-300-L Model, Tcase at 75°C

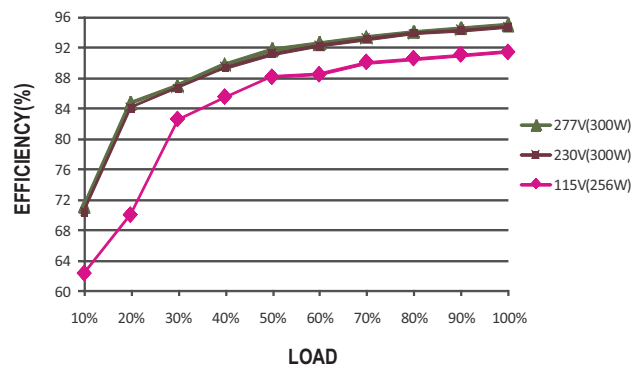



■ LIFE TIME

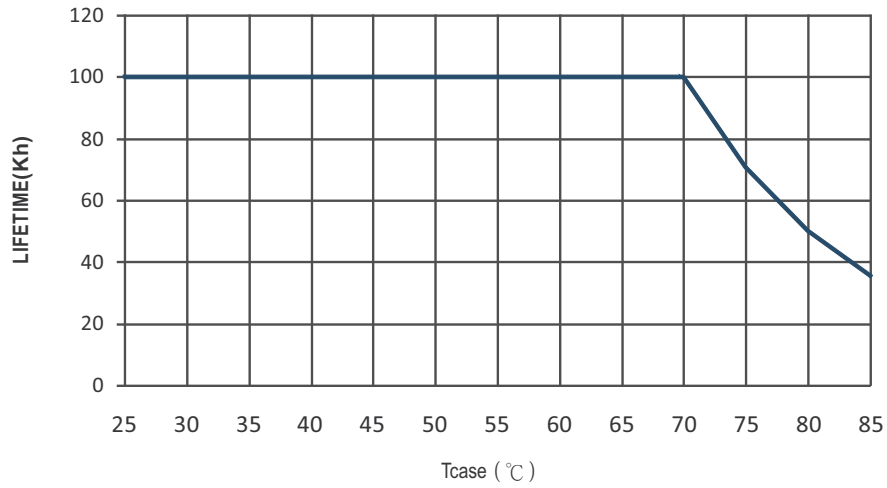

MECHANICAL SPECIFICATION

Case No.:266A Unit:mm

※ A-Type

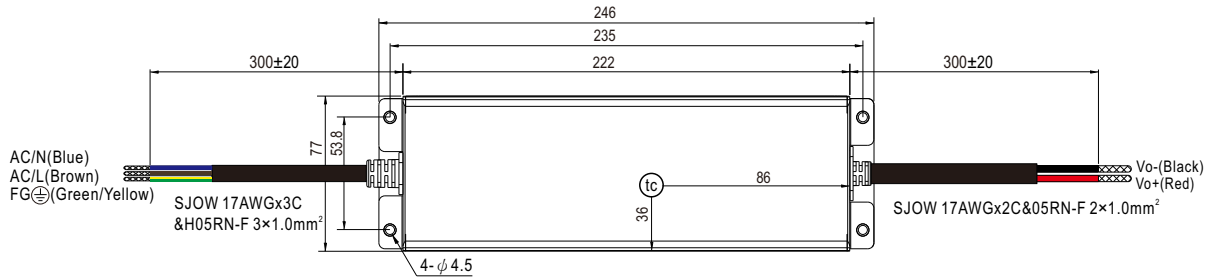

• (tc) : Max. Case Temperature

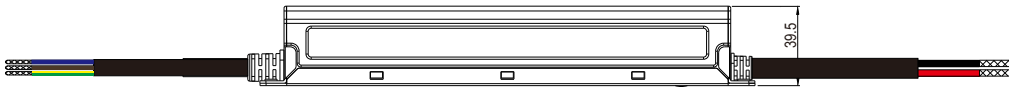

※ AB-Type

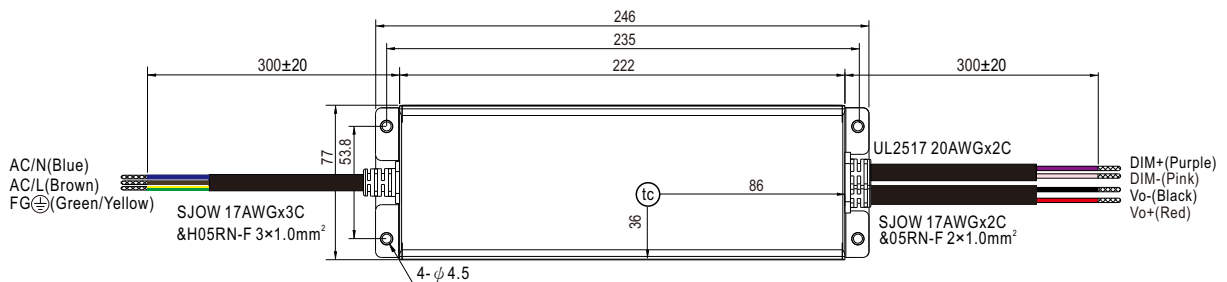

• (tc) : Max. Case Temperature

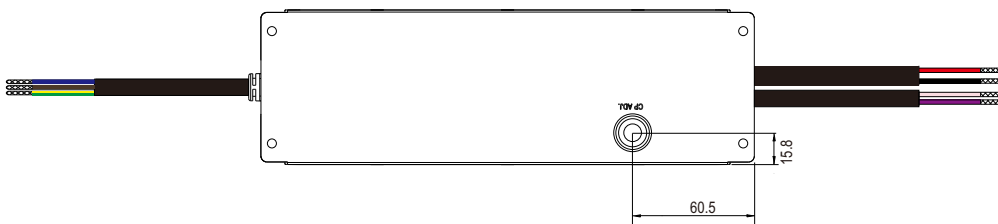
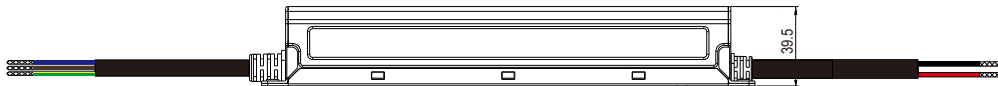

※ D2-Type

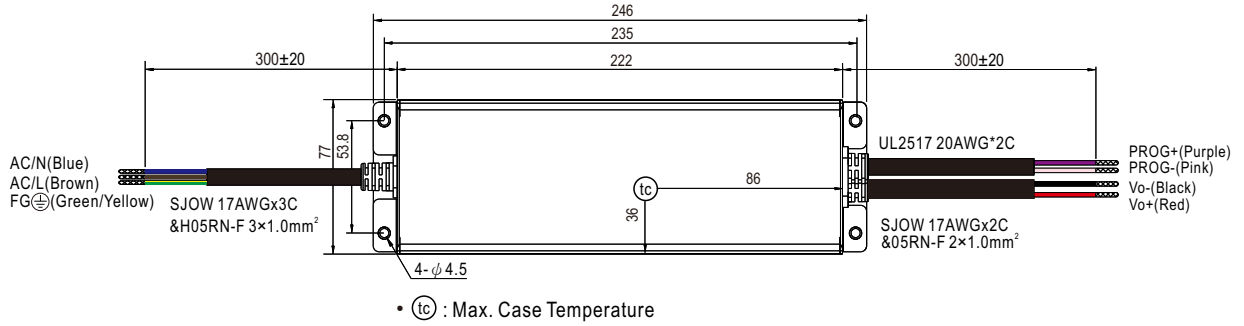

※ ADA-Type

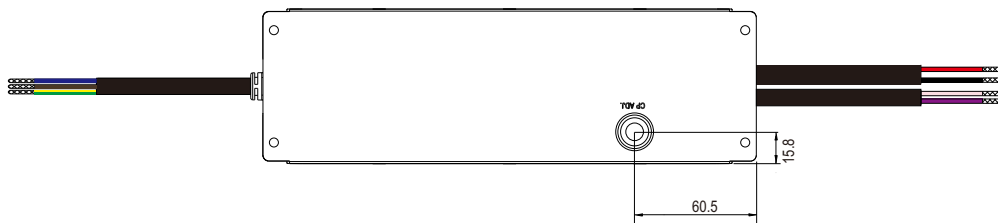
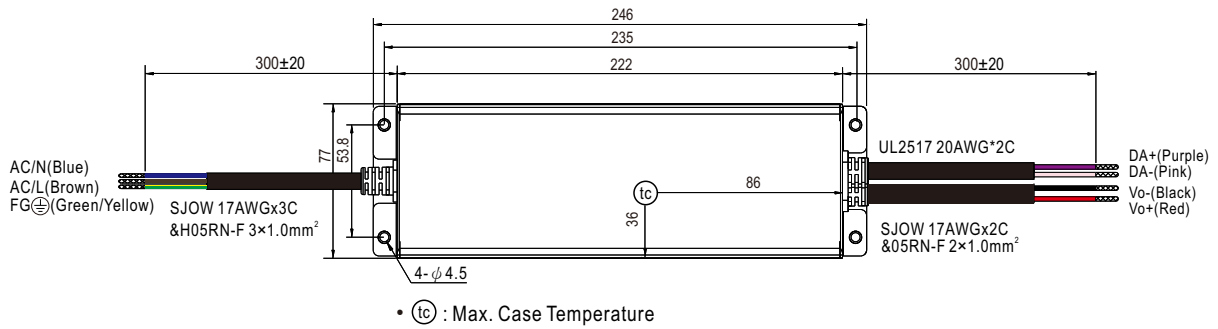

■ Recommend Mounting Direction

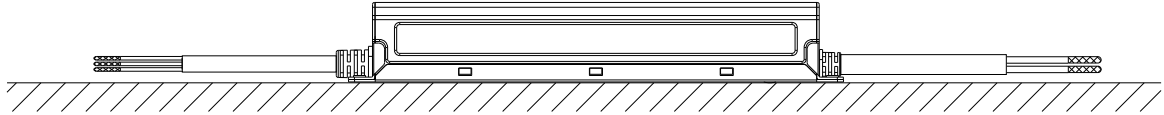

■ INSTALLATION MANUAL

Please refer to : <http://www.meanwell.com/manual.html>