

512-Kbit (64 K × 8) Serial (I²C) F-RAM

Features

- 512-Kbit ferroelectric random access memory (F-RAM) logically organized as 64 K × 8
 - High-endurance 100 trillion (10¹⁴) read/writes
 - 151-year data retention (See the [Data Retention and Endurance](#) table)
 - NoDelay™ writes
 - Advanced high-reliability ferroelectric process
- Fast 2-wire Serial interface (I²C)
 - Up to 3.4-MHz frequency
 - Direct hardware replacement for serial (I²C) EEPROM
 - Supports legacy timings for 100 kHz and 400 kHz
- Device ID
 - Manufacturer ID and Product ID
- Low power consumption
 - 175 μA active current at 100 kHz
 - 90 μA (typ) standby current
 - 5 μA (typ) sleep mode current
- Low-voltage operation: V_{DD} = 2.0 V to 3.6 V
- Industrial temperature: -40 °C to +85 °C
- 8-pin small outline integrated circuit (SOIC) package
- Restriction of hazardous substances (RoHS) compliant

Functional Overview

The FM24V05 is a 512-Kbit nonvolatile memory employing an advanced ferroelectric process. A ferroelectric random access memory or F-RAM is nonvolatile and performs reads and writes similar to a RAM. It provides reliable data retention for 151 years while eliminating the complexities, overhead, and system-level reliability problems caused by EEPROM and other nonvolatile memories.

Unlike EEPROM, the FM24V05 performs write operations at bus speed. No write delays are incurred. Data is written to the memory array immediately after each byte is successfully transferred to the device. The next bus cycle can commence without the need for data polling. In addition, the product offers substantial write endurance compared with other nonvolatile memories. Also, F-RAM exhibits much lower power during writes than EEPROM since write operations do not require an internally elevated power supply voltage for write circuits. The FM24V05 is capable of supporting 10¹⁴ read/write cycles, or 100 million times more write cycles than EEPROM.

These capabilities make the FM24V05 ideal for nonvolatile memory applications, requiring frequent or rapid writes. Examples range from data logging, where the number of write cycles may be critical, to demanding industrial controls where the long write time of EEPROM can cause data loss. The combination of features allows more frequent data writing with less overhead for the system.

The FM24V05 provides substantial benefits to users of serial (I²C) EEPROM as a hardware drop-in replacement. The device incorporates a read-only Device ID that allows the host to determine the manufacturer, product density, and product revision. The device specifications are guaranteed over an industrial temperature range of -40 °C to +85 °C.

Logic Block Diagram

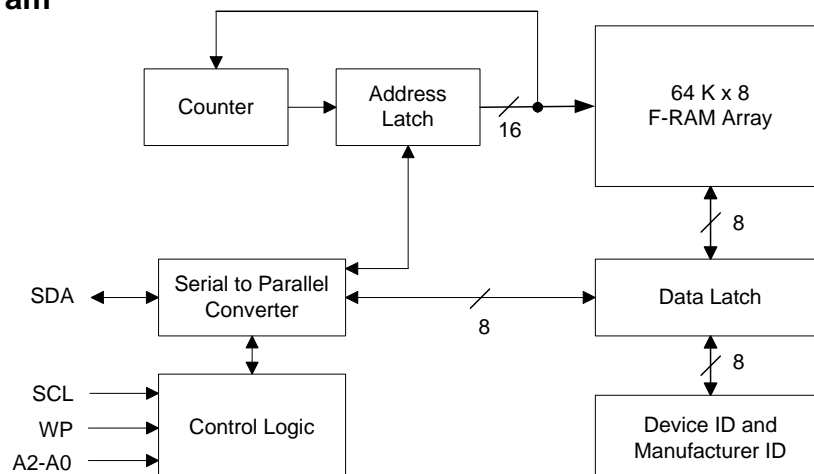

Contents

Pinout	3	Data Retention and Endurance	12
Pin Definitions	3	Capacitance	12
Overview	4	Thermal Resistance	12
Memory Architecture	4	AC Test Loads and Waveforms	12
I2C Interface	4	AC Test Conditions	12
STOP Condition (P).....	4	AC Switching Characteristics	13
START Condition (S).....	4	Power Cycle Timing	14
Data/Address Transfer	5	Ordering Information	15
Acknowledge / No-acknowledge	5	Ordering Code Definitions	15
Slave Device Address	6	Package Diagram	16
High Speed Mode (Hs-mode).....	6	Acronyms	17
Addressing Overview	6	Document Conventions	17
Data Transfer	6	Units of Measure	17
Memory Operation	6	Document History Page	18
Write Operation	6	Sales, Solutions, and Legal Information	19
Read Operation	7	Worldwide Sales and Design Support.....	19
Sleep Mode	9	Products	19
Device ID	10	PSoC® Solutions	19
Maximum Ratings	11	Cypress Developer Community.....	19
Operating Range	11	Technical Support	19
DC Electrical Characteristics	11		

Pinout

Figure 1. 8-pin SOIC pinout

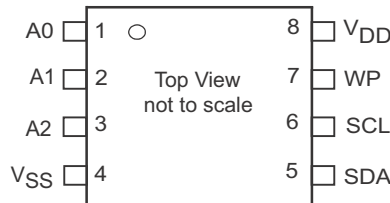

Pin Definitions

Pin Name	I/O Type	Description
A2-A0	Input	Device Select Address 2-0. These pins are used to select one of up to 8 devices of the same type on the same I ² C bus. To select the device, the address value on the three pins must match the corresponding bits contained in the slave address. The address pins are pulled down internally.
SDA	Input/Output	Serial Data/Address. This is a bi-directional pin for the I ² C interface. It is open-drain and is intended to be wire-AND'd with other devices on the I ² C bus. The input buffer incorporates a Schmitt trigger for noise immunity and the output driver includes slope control for falling edges. An external pull-up resistor is required.
SCL	Input	Serial Clock. The serial clock pin for the I ² C interface. Data is clocked out of the device on the falling edge, and into the device on the rising edge. The SCL input also incorporates a Schmitt trigger input for noise immunity.
WP	Input	Write Protect. When tied to V _{DD} , addresses in the entire memory map will be write-protected. When WP is connected to ground, all addresses are write enabled. This pin is pulled down internally.
V _{SS}	Power supply	Ground for the device. Must be connected to the ground of the system.
V _{DD}	Power supply	Power supply input to the device.

Overview

The FM24V05 is a serial F-RAM memory. The memory array is logically organized as 65,536 × 8 bits and is accessed using an industry-standard I²C interface. The functional operation of the F-RAM is similar to serial (I²C) EEPROM. The major difference between the FM24V05 and a serial (I²C) EEPROM with the same pinout is the F-RAM's superior write performance, high endurance, and low power consumption.

Memory Architecture

When accessing the FM24V05, the user addresses 64K locations of eight data bits each. These eight data bits are shifted in or out serially. The addresses are accessed using the I²C protocol, which includes a slave address (to distinguish other non-memory devices) and a two-byte address. The complete address of 16 bits specifies each byte address uniquely.

The access time for the memory operation is essentially zero, beyond the time needed for the serial protocol. That is, the memory is read or written at the speed of the I²C bus. Unlike a serial (I²C) EEPROM, it is not necessary to poll the device for a ready condition because writes occur at bus speed. By the time

a new bus transaction can be shifted into the device, a write operation is complete. This is explained in more detail in the interface section.

I²C Interface

The FM24V05 employs a bi-directional I²C bus protocol using few pins or board space. Figure 2 illustrates a typical system configuration using the FM24V05 in a microcontroller-based system. The industry standard I²C bus is familiar to many users but is described in this section.

By convention, any device that is sending data onto the bus is the transmitter while the target device for this data is the receiver. The device that is controlling the bus is the master. The master is responsible for generating the clock signal for all operations. Any device on the bus that is being controlled is a slave. The FM24V05 is always a slave device.

The bus protocol is controlled by transition states in the SDA and SCL signals. There are four conditions including START, STOP, data bit, or acknowledge. Figure 3 and Figure 4 illustrates the signal conditions that specify the four states. Detailed timing diagrams are shown in the electrical specifications section.

Figure 2. System Configuration using Serial (I²C) nvSRAM

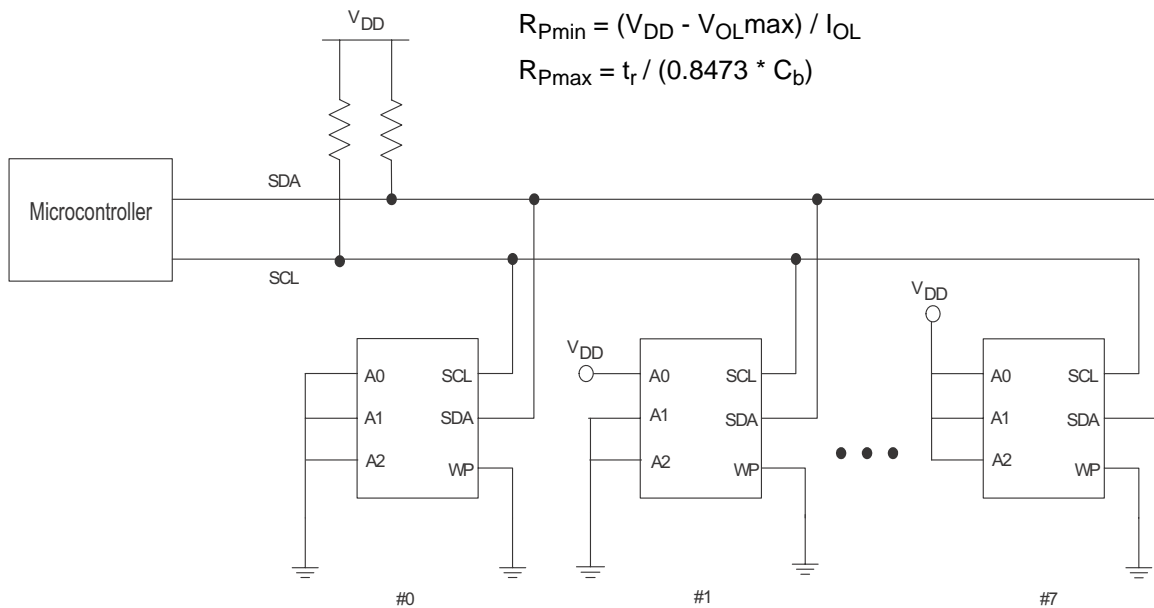

STOP Condition (P)

A STOP condition is indicated when the bus master drives SDA from LOW to HIGH while the SCL signal is HIGH. All operations using the FM24V05 should end with a STOP condition. If an operation is in progress when a STOP is asserted, the operation will be aborted. The master must have control of SDA in order to assert a STOP condition.

START Condition (S)

A START condition is indicated when the bus master drives SDA from HIGH to LOW while the SCL signal is HIGH. All commands should be preceded by a START condition. An operation in progress can be aborted by asserting a START condition at any time. Aborting an operation using the START condition will ready the FM24V05 for a new operation.

If during operation the power supply drops below the specified V_{DD} minimum, the system should issue a START condition prior to performing another operation.

Figure 3. START and STOP Conditions



Figure 4. Data Transfer on the I²C Bus



Data/Address Transfer

All data transfers (including addresses) take place while the SCL signal is HIGH. Except under the three conditions described above, the SDA signal should not change while SCL is HIGH.

Acknowledge / No-acknowledge

The acknowledge takes place after the 8th data bit has been transferred in any transaction. During this state the transmitter should release the SDA bus to allow the receiver to drive it. The receiver drives the SDA signal LOW to acknowledge receipt of the byte. If the receiver does not drive SDA LOW, the condition is a no-acknowledge and the operation is aborted.

The receiver would fail to acknowledge for two distinct reasons. First is that a byte transfer fails. In this case, the no-acknowledge ceases the current operation so that the device can be addressed again. This allows the last byte to be recovered in the event of a communication error.

Second and most common, the receiver does not acknowledge to deliberately end an operation. For example, during a read operation, the FM24V05 will continue to place data onto the bus as long as the receiver sends acknowledges (and clocks). When a read operation is complete and no more data is needed, the receiver must not acknowledge the last byte. If the receiver acknowledges the last byte, this will cause the FM24V05 to attempt to drive the bus on the next clock while the master is sending a new command such as STOP.

Figure 5. Acknowledge on the I²C Bus

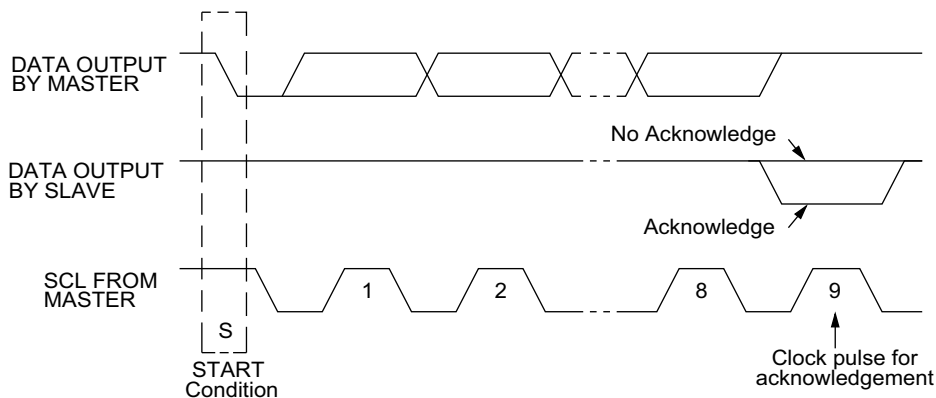

Slave Device Address

The first byte that the FM24V05 expects after a START condition is the slave address. As shown in Figure 6, the slave address contains the device type or slave ID, the device select address bits, and a bit that specifies if the transaction is a read or a write.

Bits 7-4 are the device type (slave ID) and should be set to 1010b for the FM24V05. These bits allow other function types to reside on the I²C bus within an identical address range. Bits 3-1 are the device select address bits. They must match the corresponding value on the external address pins to select the device. Up to eight FM24V05 devices can reside on the same I²C bus by assigning a different address to each. Bit 0 is the read/write bit (R/W). R/W = '1' indicates a read operation and R/W = '0' indicates a write operation.

Figure 6. Memory Slave Device Address

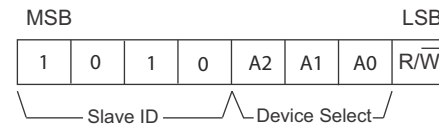

High Speed Mode (Hs-mode)

The FM24V05 supports a 3.4-MHz high speed mode. A master code (00001XXXb) must be issued to place the device into high speed mode. Communication between master and slave will then be enabled for speeds up to 3.4-MHz. A STOP condition will exit Hs-mode. Single- and multiple-byte reads and writes are supported.

Figure 7. Data transfer format in Hs-mode

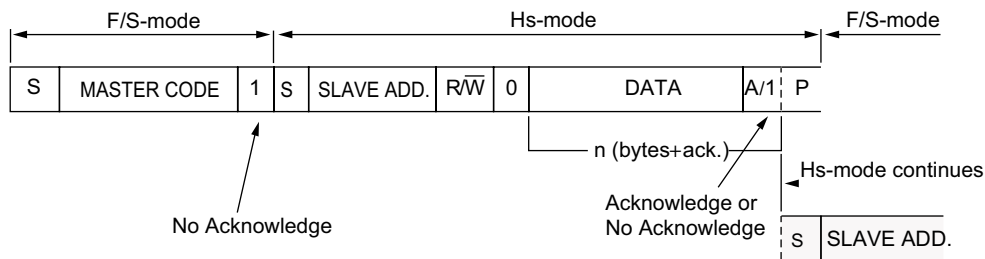

Addressing Overview

After the FM24V05 (as receiver) acknowledges the slave address, the master can place the memory address on the bus for a write operation. The address requires two bytes. The complete 16-bit address is latched internally. Each access causes the latched address value to be incremented automatically. The current address is the value that is held in the latch; either a newly written value or the address following the last access. The current address will be held for as long as power remains or until a new value is written. Reads always use the current address. A random read address can be loaded by beginning a write operation as explained below.

After transmission of each data byte, just prior to the acknowledge, the FM24V05 increments the internal address latch. This allows the next sequential byte to be accessed with no additional addressing. After the last address (FFFFh) is reached, the address latch will roll over to 0000h. There is no limit to the number of bytes that can be accessed with a single read or write operation.

Data Transfer

After the address bytes have been transmitted, data transfer between the bus master and the FM24V05 can begin. For a read operation the FM24V05 will place 8 data bits on the bus then wait for an acknowledge from the master. If the acknowledge occurs, the FM24V05 will transfer the next sequential byte. If the acknowledge is not sent, the FM24V05 will end the read operation. For a write operation, the FM24V05 will accept 8 data bits from the master then send an acknowledge. All data transfer occurs MSB (most significant bit) first.

Memory Operation

The FM24V05 is designed to operate in a manner very similar to other I²C interface memory products. The major differences result from the higher performance write capability of F-RAM technology. These improvements result in some differences between the FM24V05 and a similar configuration EEPROM during writes. The complete operation for both writes and reads is explained below.

Write Operation

All writes begin with a slave address, then a memory address. The bus master indicates a write operation by setting the LSB of the slave address (R/W bit) to a '0'. After addressing, the bus master sends each byte of data to the memory and the memory generates an acknowledge condition. Any number of sequential bytes may be written. If the end of the address range is reached internally, the address counter will wrap from FFFFh to 0000h.

Unlike other nonvolatile memory technologies, there is no effective write delay with F-RAM. Since the read and write access times of the underlying memory are the same, the user experiences no delay through the bus. The entire memory cycle occurs in less time than a single bus clock. Therefore, any operation including read or write can occur immediately following a write. Acknowledge polling, a technique used with EEPROMs to determine if a write is complete is unnecessary and will always return a ready condition.

Internally, an actual memory write occurs after the 8th data bit is transferred. It will be complete before the acknowledge is sent. Therefore, if the user desires to abort a write without altering the memory contents, this should be done using START or STOP

condition prior to the 8th data bit. The FM24V05 uses no page buffering.

The memory array can be write-protected using the WP pin. Setting the WP pin to a HIGH condition (V_{DD}) will write-protect all addresses. The FM24V05 will not acknowledge data bytes that are written to protected addresses. In addition, the address

counter will not increment if writes are attempted to these addresses. Setting WP to a LOW state (V_{SS}) will disable the write protect. WP is pulled down internally.

Figure 8 and Figure 9 below illustrate a single-byte and multiple-byte write cycles in F/S mode. Figure 10 below illustrate a single-byte write cycles in Hs mode

Figure 8. Single-Byte Write

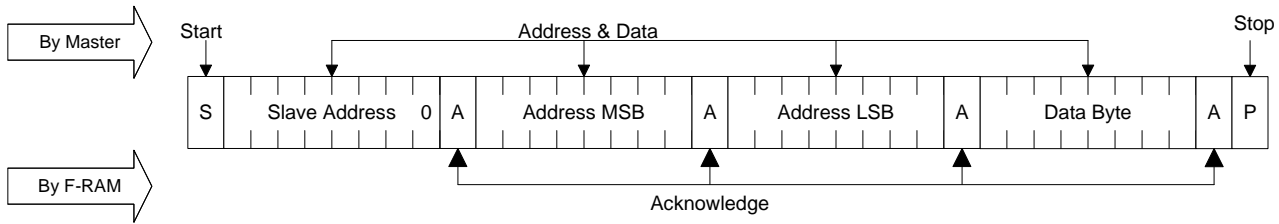

Figure 9. Multi-Byte Write

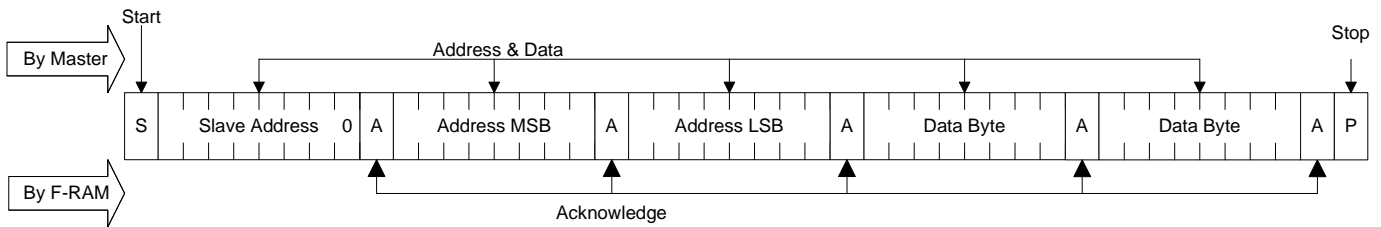
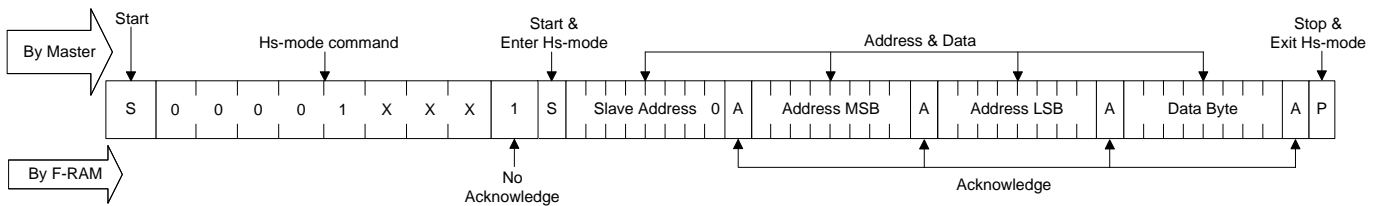

Figure 10. Hs-mode Byte Write



Read Operation

There are two basic types of read operations. They are current address read and selective address read. In a current address read, the FM24V05 uses the internal address latch to supply the address. In a selective read, the user performs a procedure to set the address to a specific value.

Current Address & Sequential Read

As mentioned above the FM24V05 uses an internal latch to supply the address for a read operation. A current address read uses the existing value in the address latch as a starting place for the read operation. The system reads from the address immediately following that of the last operation.

To perform a current address read, the bus master supplies a slave address with the LSB set to a '1'. This indicates that a read operation is requested. After receiving the complete slave address, the FM24V05 will begin shifting out data from the current address on the next clock. The current address is the value held in the internal address latch.

Beginning with the current address, the bus master can read any number of bytes. Thus, a sequential read is simply a current address read with multiple byte transfers. After each byte the internal address counter will be incremented.

Note Each time the bus master acknowledges a byte, this indicates that the FM24V05 should read out the next sequential byte.

There are four ways to properly terminate a read operation. Failing to properly terminate the read will most likely create a bus contention as the FM24V05 attempts to read out additional data onto the bus. The four valid methods are:

1. The bus master issues a no-acknowledge in the 9th clock cycle and a STOP in the 10th clock cycle. This is illustrated in the diagrams below. This is preferred.
2. The bus master issues a no-acknowledge in the 9th clock cycle and a START in the 10th.
3. The bus master issues a STOP in the 9th clock cycle.
4. The bus master issues a START in the 9th clock cycle.

If the internal address reaches FFFFh, it will wrap around to 0000h on the next read cycle. [Figure 11](#) and [Figure 12](#) below show the proper operation for current address reads.

Figure 11. Current Address Read

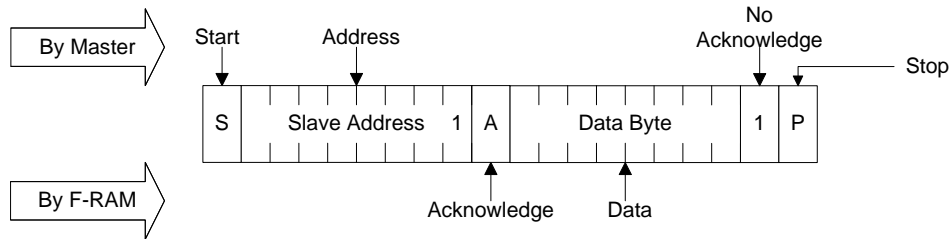

Figure 12. Sequential Read

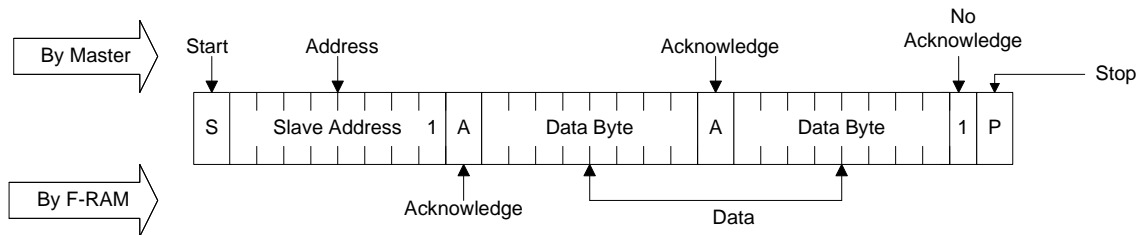
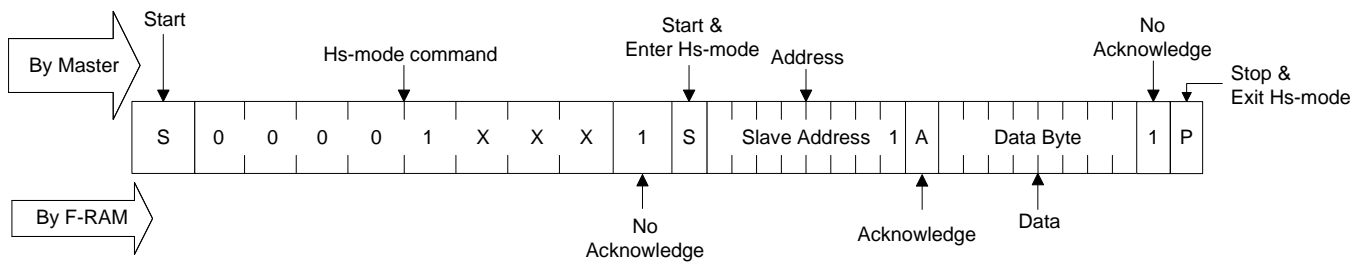

Figure 13. Hs-mode Current Address Read



Selective (Random) Read

There is a simple technique that allows a user to select a random address location as the starting point for a read operation. This involves using the first three bytes of a write operation to set the internal address followed by subsequent read operations.

To perform a selective read, the bus master sends out the slave address with the LSB (R/W) set to 0. This specifies a write

operation. According to the write protocol, the bus master then sends the address bytes that are loaded into the internal address latch. After the FM24V05 acknowledges the address, the bus master issues a START condition. This simultaneously aborts the write operation and allows the read command to be issued with the slave address LSB set to a '1'. The operation is now a current address read.

Figure 14. Selective (Random) Read

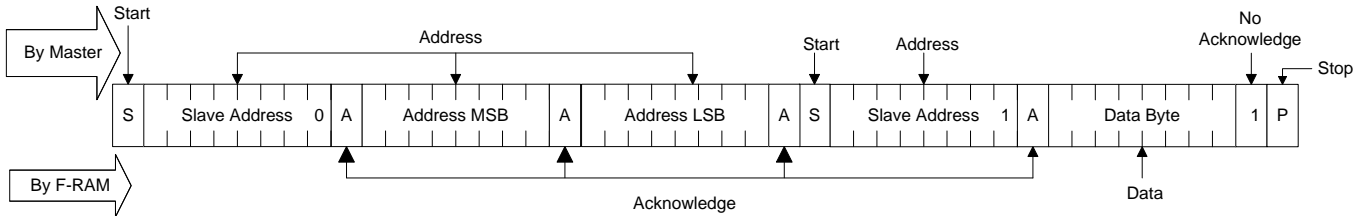

Sleep Mode

A low power mode called Sleep Mode is implemented on the FM24V05 device. The device will enter this low power state when the Sleep command 86h is clocked-in. Sleep Mode entry can be entered as follows:

1. The master sends a START command.
2. The master sends Reserved Slave ID F8h.
3. The FM24V05 sends an ACK.
4. The master sends the I²C-bus slave address of the slave device it needs to identify. The last bit is a 'Don't care' value (R/W bit). Only one device must acknowledge this byte (the one that has the I²C-bus slave address).
5. The FM24V05 sends an ACK.

6. The master sends a Re-START command.
7. The master sends Reserved Slave ID 86h.
8. The FM24V05 sends an ACK.
9. The master sends STOP to ensure the device enters sleep mode.

Once in sleep mode, the device draws I_{ZZ} current, but the device continues to monitor the I²C pins. Once the master sends a Slave Address that the FM24V05 identifies, it will "wakeup" and be ready for normal operation within t_{REC} time. As an alternative method of determining when the device is ready, the master can send read or write commands and look for an ACK. While the device is waking up, it will NACK the master until it is ready.

Figure 15. Sleep Mode Entry

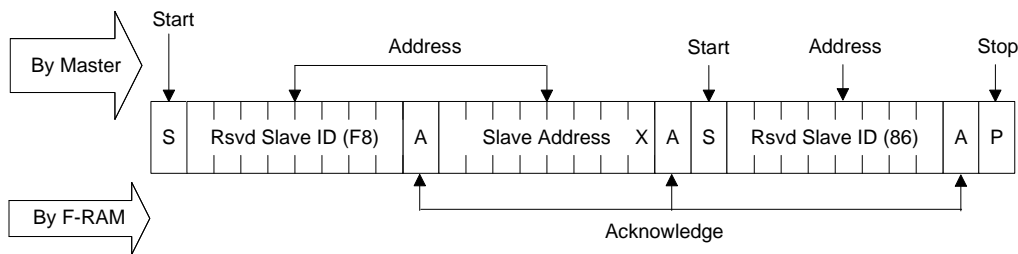

Device ID

The FM24V05 device incorporates a means of identifying the device by providing three bytes of data, which are manufacturer ID, product ID, and die revision. The Device ID is read-only. It can be accessed as follows:

1. The master sends a START command.
2. The master sends Reserved Slave ID F8h.
3. The FM24V05 sends an ACK.
4. The master sends the I²C-bus slave address of the slave device it needs to identify. The last bit is a 'Don't care' value (R/W bit). Only one device must acknowledge this byte (the one that has the I²C-bus slave address).

5. The FM24V05 sends an ACK.
6. The master sends a Re-START command.
7. The master sends Reserved Slave ID F9h.
8. The FM24V05 sends an ACK.
9. The Device ID Read can be done, starting with the 12 manufacturer bits, followed by the 9 device identification bits, and then the 3 die revision bits.
10. The master ends the Device ID read sequence by NACKing the last byte, thus resetting the slave device state machine and allowing the master to send the STOP command.

Note The reading of the Device ID can be stopped anytime by sending a NACK command.

Table 1. Device ID

Device ID (3 bytes)	Device ID Description			
	23–12 (12 bits)	11–8 (4 bits)	7–3 (5 bits)	2–0 (3 bits)
	Manufacturer ID	Product ID		
		Density	Variation	Die Rev
004300h	00000000100	0011	00000	000

Note Product ID bits 0 and 4 are reserved.

Figure 16. Read Device ID

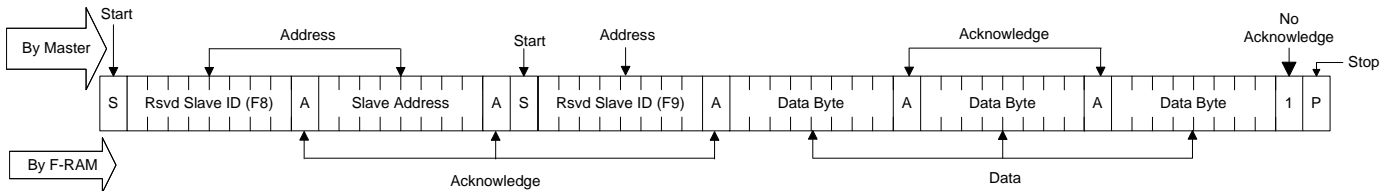

Maximum Ratings

Exceeding maximum ratings may shorten the useful life of the device. These user guidelines are not tested.

Storage temperature	-55 °C to +125 °C
Maximum junction temperature	95 °C
Supply voltage on V _{DD} relative to V _{SS}	-1.0 V to +4.5 V
Input voltage	-1.0 V to + 4.5 V and V _{IN} < V _{DD} + 1.0 V
DC voltage applied to outputs in High-Z state	-0.5 V to V _{DD} + 0.5 V
Transient voltage (< 20 ns) on any pin to ground potential	-2.0 V to V _{DD} + 2.0 V
Package power dissipation capability (T _A = 25 °C)	1.0 W

Surface mount lead soldering temperature (10 seconds)	+260 °C
Electrostatic Discharge Voltage	
Human Body Model (AEC-Q100-002 Rev. E)	2.5 kV
Charged Device Model (AEC-Q100-011 Rev. B)	1.25 kV
Machine Model (AEC-Q100-003 Rev. E)	200 V
Latch-up current	> 140 mA

* Exception: The "V_{IN} < V_{DD} + 1.0 V" restriction does not apply to the SCL and SDA inputs.

Operating Range

Range	Ambient Temperature (T _A)	V _{DD}
Industrial	-40 °C to +85 °C	2.0 V to 3.6 V

DC Electrical Characteristics

Over the [Operating Range](#)

Parameter	Description	Test Conditions	Min	Typ ^[1]	Max	Unit	
V _{DD}	Power supply		2.0	3.3	3.6	V	
I _{DD}	Average V _{DD} current	SCL toggling between V _{DD} - 0.2 V and V _{SS} , other inputs V _{SS} or V _{DD} - 0.2 V.	f _{SCL} = 100 kHz	-	-	175	μA
			f _{SCL} = 1 MHz	-	-	400	μA
			f _{SCL} = 3.4 MHz	-	-	1000	μA
I _{SB}	Standby current	SCL = SDA = V _{DD} . All other inputs V _{SS} or V _{DD} . Stop command issued.	-	90	150	μA	
I _{ZZ}	Sleep mode current	SCL = SDA = V _{DD} . All other inputs V _{SS} or V _{DD} . Stop command issued.	-	5	8	μA	
I _{LI}	Input leakage current (Except WP and A2-A0)	V _{SS} ≤ V _{IN} ≤ V _{DD}	-1	-	+1	μA	
	Input leakage current (for WP and A2-A0)	V _{SS} ≤ V _{IN} ≤ V _{DD}	-1	-	+100	μA	
I _{LO}	Output leakage current	V _{SS} ≤ V _{IN} ≤ V _{DD}	-1	-	+1	μA	
V _{IH}	Input HIGH voltage		0.7 × V _{DD}	-	V _{DD} + 0.3	V	
V _{IL}	Input LOW voltage		-0.3	-	0.3 × V _{DD}	V	
V _{OL1}	Output LOW voltage	I _{OL} = 2 mA, V _{DD} ≥ 2.7 V	-	-	0.4	V	
V _{OL2}	Output LOW voltage	I _{OL} = 150 μA	-	-	0.2	V	
R _{in} ^[2]	Input resistance (WP, A2-A0)	For V _{IN} = V _{IL} (Max)	50	-	-	kΩ	
		For V _{IN} = V _{IH} (Min)	1	-	-	MΩ	

Notes

- Typical values are at 25 °C, V_{DD} = V_{DD} (typ). Not 100% tested.
- The input pull-down circuit is strong (50 kΩ) when the input voltage is below V_{IL} and weak (1 MΩ) when the input voltage is above V_{IH}.

Data Retention and Endurance

Parameter	Description	Test condition	Min	Max	Unit
T _{DR}	Data retention	T _A = 85 °C	10	–	Years
		T _A = 75 °C	38	–	
		T _A = 65 °C	151	–	
NV _C	Endurance	Over operating temperature	10 ¹⁴	–	Cycles

Capacitance

Parameter ^[3]	Description	Test Conditions	Max	Unit
C _O	Output pin capacitance (SDA)	T _A = 25 °C, f = 1 MHz, V _{DD} = V _{DD} (typ)	8	pF
C _I	Input pin capacitance		6	pF

Thermal Resistance

Parameter ^[3]	Description	Test Conditions	8-pin SOIC	Unit
Θ _{JA}	Thermal resistance (junction to ambient)	Test conditions follow standard test methods and procedures for measuring thermal impedance, per EIA / JESD51.	137	°C/W
Θ _{JC}	Thermal resistance (junction to case)		40	°C/W

AC Test Loads and Waveforms

Figure 17. AC Test Loads and Waveforms

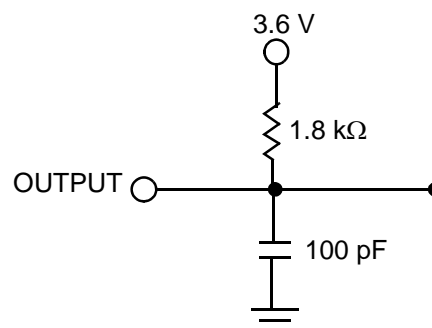

AC Test Conditions

Input pulse levels10% and 90% of V_{DD}
 Input rise and fall times10 ns
 Input and output timing reference levels0.5 × V_{DD}
 Output load capacitance 100 pF

Note

3. These parameters are guaranteed by design and are not tested.

AC Switching Characteristics

Over the [Operating Range](#)

Parameter ^[4]	Alt. Parameter	Description	F/S-mode ^[6]		Hs-mode ^[6]		Unit
			Min	Max	Min	Max	
f_{SCL} ^[5]		SCL clock frequency	–	1.0	–	3.4	MHz
$t_{SU;STA}$		Start condition setup for repeated Start	260	–	160	–	ns
$t_{HD;STA}$		Start condition hold time	260	–	160	–	ns
t_{LOW}		Clock LOW period	500	–	160	–	ns
t_{HIGH}		Clock HIGH period	260	–	60	–	ns
$t_{SU;DAT}$ ^[7]	$t_{SU;DATA}$	Data in setup	50	–	10	–	ns
$t_{HD;DAT}$	$t_{HD;DATA}$	Data in hold	0	–	0	–	ns
t_{DH}		Data output hold (from SCL @ V_{IL})	0	–	0	–	ns
t_R ^[8]	t_r	Input rise time	–	120	–	80	ns
t_F ^[8]	t_f	Input fall time	–	120	–	80	ns
$t_{SU;STO}$		STOP condition setup	260	–	160	–	ns
t_{AA}	$t_{VD;DATA}$	SCL LOW to SDA Data Out Valid	–	450	–	130	ns
t_{BUF}		Bus free before new transmission	500	–	300	–	ns
t_{SP}		Noise suppression time constant on SCL, SDA	–	50	–	5	ns

Figure 18. Read Bus Timing Diagram

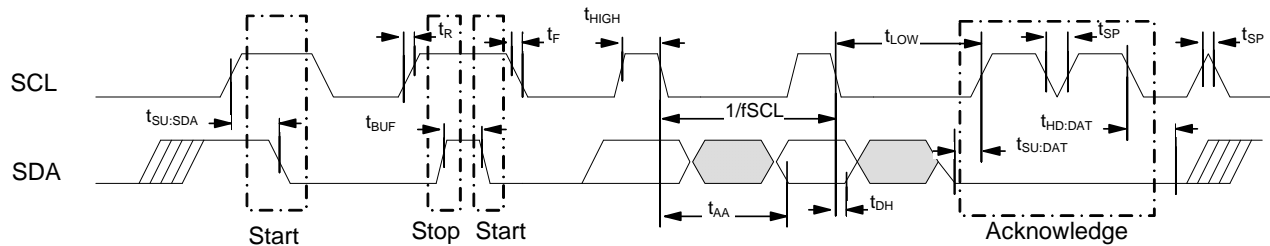
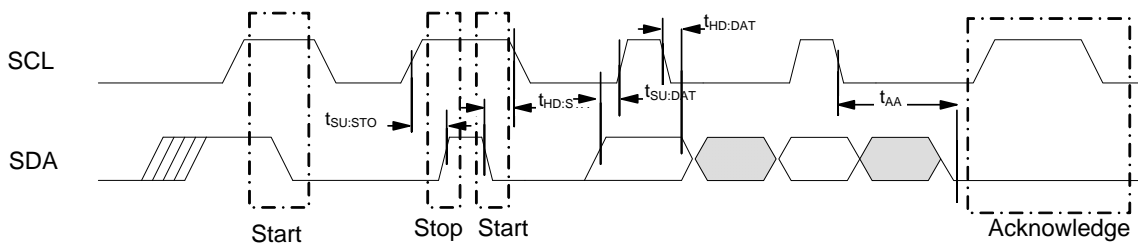

Figure 19. Write Bus Timing Diagram



Notes

4. Test conditions assume signal transition time of 10 ns or less, timing reference levels of $V_{DD}/2$, input pulse levels of 0 to V_{DD} (typ), and output loading of the specified I_{OL} and load capacitance shown in [Figure 17](#).
5. The speed-related specifications are guaranteed characteristic points along a continuous curve of operation from DC to f_{SCL} (max).
6. Bus Load (C_b) considerations; $C_b < 500$ pF for I²C clock frequency (SCL) 1 MHz; $C_b < 100$ pF for SCL at 3.4 MHz.
7. In Hs-mode and $V_{DD} < 2.7$ V, the $t_{SU;DAT}$ (min.) spec is 15 ns.
8. These parameters are guaranteed by design and are not tested.

Power Cycle Timing

Over the [Operating Range](#)

Parameter	Description	Min	Max	Unit
t_{PU}	Power-up $V_{DD(min)}$ to first access (START condition)	250	–	μs
t_{PD}	Last access (STOP condition) to power-down ($V_{DD(min)}$)	0	–	μs
$t_{VR}^{[9, 10]}$	V_{DD} power-up ramp rate	50	–	$\mu s/V$
$t_{VF}^{[9, 10]}$	V_{DD} power-down ramp rate	100	–	$\mu s/V$
$t_{REC}^{[10]}$	Recovery time from sleep mode	–	400	μs

Figure 20. Power Cycle Timing

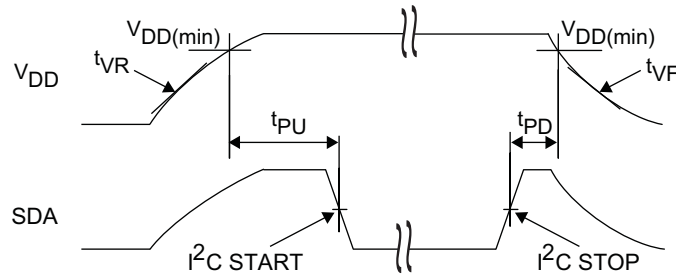

Notes

- 9. Slope measured at any point on the V_{DD} waveform.
- 10. Guaranteed by design.

Ordering Information

Ordering Code	Package Diagram	Package Type	Operating Range
FM24V05-G	001-85066	8-pin SOIC	Industrial
FM24V05-GTR			

All these parts are Pb-free. Contact your local Cypress sales representative for availability of these parts.

Ordering Code Definitions

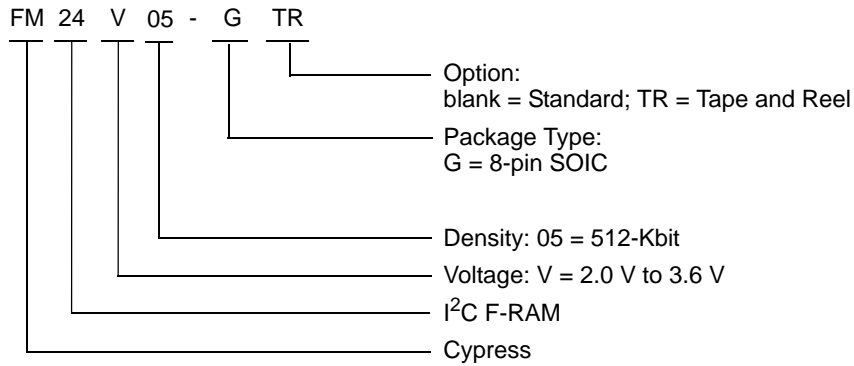

Package Diagram

Figure 21. 8-pin SOIC (150 mils) Package Outline, 51-85066

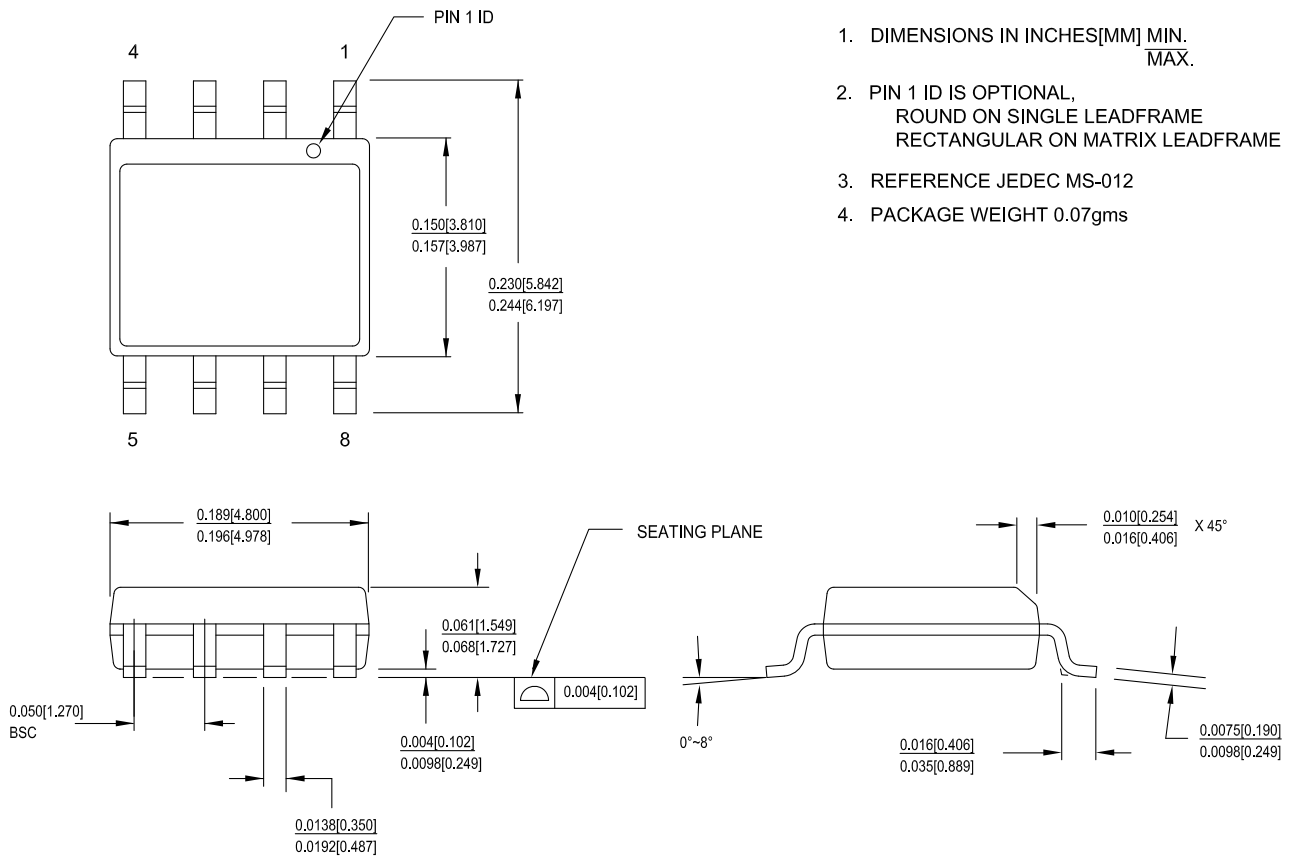

1. DIMENSIONS IN INCHES[MM] MIN.
MAX.
2. PIN 1 ID IS OPTIONAL,
ROUND ON SINGLE LEADFRAME
RECTANGULAR ON MATRIX LEADFRAME
3. REFERENCE JEDEC MS-012
4. PACKAGE WEIGHT 0.07gms

51-85066 *F

Acronyms

Acronym	Description
ACK	Acknowledge
CMOS	Complementary Metal Oxide Semiconductor
EIA	Electronic Industries Alliance
I ² C	Inter-Integrated Circuit
I/O	Input/Output
JEDEC	Joint Electron Devices Engineering Council
LSB	Least Significant Bit
MSB	Most Significant Bit
NACK	No Acknowledge
RoHS	Restriction of Hazardous Substances
R/W	Read/Write
SCL	Serial Clock Line
SDA	Serial Data Access
SOIC	Small Outline Integrated Circuit
WP	Write Protect

Document Conventions

Units of Measure

Symbol	Unit of Measure
°C	degree Celsius
Hz	hertz
Kb	1024 bit
kHz	kilohertz
kΩ	kilohm
MHz	megahertz
MΩ	megaohm
μA	microampere
μs	microsecond
mA	milliampere
ms	millisecond
ns	nanosecond
Ω	ohm
%	percent
pF	picofarad
V	volt
W	watt

Document History Page

Document Title: FM24V05, 512-Kbit (64 K × 8) Serial (I ² C) F-RAM				
Document Number: 001-84462				
Rev.	ECN No.	Submission Date	Orig. of Change	Description of Change
**	3902204	02/25/2013	GVCH	New spec
*A	3985098	05/09/2013	GVCH	Removed FM24VN05 part related information Updated SOIC package marking scheme
*B	4014247	05/29/2013	GVCH	Added Appendix A - Errata for FM24V05
*C	4045469	06/30/2013	GVCH	All errata items are fixed and the errata is removed.
*D	4283417	02/18/2014	GVCH	Converted to Cypress standard format Updated Maximum Ratings table - Removed Moisture Sensitivity Level (MSL) - Added junction temperature and latch up current Added Input leakage current (I _{LI}) for WP and A2-A0 Updated Data Retention and Endurance table Added Thermal Resistance table Removed Package Marking Scheme (top mark)

Sales, Solutions, and Legal Information

Worldwide Sales and Design Support

Cypress maintains a worldwide network of offices, solution centers, manufacturer's representatives, and distributors. To find the office closest to you, visit us at [Cypress Locations](#).

Products

Automotive	cypress.com/go/automotive
Clocks & Buffers	cypress.com/go/clocks
Interface	cypress.com/go/interface
Lighting & Power Control	cypress.com/go/powerpsoc cypress.com/go/plc
Memory	cypress.com/go/memory
PSoC	cypress.com/go/psoc
Touch Sensing	cypress.com/go/touch
USB Controllers	cypress.com/go/USB
Wireless/RF	cypress.com/go/wireless

PSoC[®] Solutions

[psoc.cypress.com/solutions](#)
[PSoC 1](#) | [PSoC 3](#) | [PSoC 4](#) | [PSoC 5LP](#)

Cypress Developer Community

[Community](#) | [Forums](#) | [Blogs](#) | [Video](#) | [Training](#)

Technical Support

[cypress.com/go/support](#)

© Cypress Semiconductor Corporation, 2013-2014. The information contained herein is subject to change without notice. Cypress Semiconductor Corporation assumes no responsibility for the use of any circuitry other than circuitry embodied in a Cypress product. Nor does it convey or imply any license under patent or other rights. Cypress products are not warranted nor intended to be used for medical, life support, life saving, critical control or safety applications, unless pursuant to an express written agreement with Cypress. Furthermore, Cypress does not authorize its products for use as critical components in life-support systems where a malfunction or failure may reasonably be expected to result in significant injury to the user. The inclusion of Cypress products in life-support systems application implies that the manufacturer assumes all risk of such use and in doing so indemnifies Cypress against all charges.

Any Source Code (software and/or firmware) is owned by Cypress Semiconductor Corporation (Cypress) and is protected by and subject to worldwide patent protection (United States and foreign), United States copyright laws and international treaty provisions. Cypress hereby grants to licensee a personal, non-exclusive, non-transferable license to copy, use, modify, create derivative works of, and compile the Cypress Source Code and derivative works for the sole purpose of creating custom software and or firmware in support of licensee product to be used only in conjunction with a Cypress integrated circuit as specified in the applicable agreement. Any reproduction, modification, translation, compilation, or representation of this Source Code except as specified above is prohibited without the express written permission of Cypress.

Disclaimer: CYPRESS MAKES NO WARRANTY OF ANY KIND, EXPRESS OR IMPLIED, WITH REGARD TO THIS MATERIAL, INCLUDING, BUT NOT LIMITED TO, THE IMPLIED WARRANTIES OF MERCHANTABILITY AND FITNESS FOR A PARTICULAR PURPOSE. Cypress reserves the right to make changes without further notice to the materials described herein. Cypress does not assume any liability arising out of the application or use of any product or circuit described herein. Cypress does not authorize its products for use as critical components in life-support systems where a malfunction or failure may reasonably be expected to result in significant injury to the user. The inclusion of Cypress' product in a life-support systems application implies that the manufacturer assumes all risk of such use and in doing so indemnifies Cypress against all charges.

Use may be limited by and subject to the applicable Cypress software license agreement.