

15A, 600V - 1000V Standard Bridge Rectifier

FEATURES

- Ideal for printed circuit board
- High surge current capability
- UL Recognized File # E-326243
- RoHS Compliant
- Halogen-free according to IEC 61249-2-21

APPLICATIONS

- Switching mode power supply (SMPS)
- Adapters
- TV
- Monitor

MECHANICAL DATA

- Case: GBU
- Molding compound meets UL 94V-0 flammability rating
- Terminal: Matte tin plated leads, solderable per J-STD-002
- Meet JESD 201 class 1 whisker test
- Polarity: As marked
- Weight: 3.96g (approximately)

KEY PARAMETERS		
PARAMETER	VALUE	UNIT
I_F	15	A
V_{RRM}	600 - 1000	V
I_{FSM}	220	A
$T_{J\ MAX}$	150	°C
Package	GBU	
Configuration	Quad	

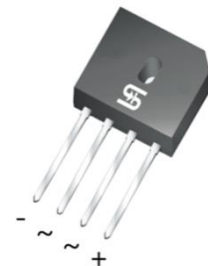

GBU

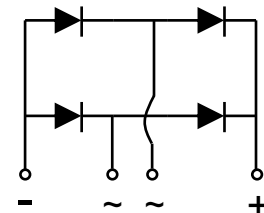

ABSOLUTE MAXIMUM RATINGS ($T_A = 25^\circ\text{C}$ unless otherwise noted)					
PARAMETER	SYMBOL	GBU1505	GBU1506	GBU1507	UNIT
Marking code on the device		GBU1505	GBU1506	GBU1507	
Repetitive peak reverse voltage	V_{RRM}	600	800	1000	V
Reverse voltage, total rms value	$V_{R(RMS)}$	420	560	700	V
Forward current	I_F	15			A
Surge peak forward current single half sine-wave superimposed on rated load per diode	$t = 8.3\text{ms}$	I_{FSM}	220		A
	$t = 1.0\text{ms}$		600		
Rating of fusing ($t < 8.3\text{ms}$)	I^2t	200			A^2s
Junction temperature	T_J	- 55 to +150			°C
Storage temperature	T_{STG}	- 55 to +150			°C

THERMAL PERFORMANCE			
PARAMETER	SYMBOL	TYP	UNIT
Junction-to-lead thermal resistance	$R_{\theta JL}$	1.5	°C/W
Junction-to-ambient thermal resistance	$R_{\theta JA}$	7.5	°C/W
Junction-to-case thermal resistance	$R_{\theta JC}$	1.0	°C/W

Thermal Performance Note: Mounted on Heat sink with 4" x 6" x 0.25" Al -Plate.

ELECTRICAL SPECIFICATIONS ($T_A = 25^\circ\text{C}$ unless otherwise noted)					
PARAMETER	CONDITIONS	SYMBOL	TYP	MAX	UNIT
Forward voltage per diode ⁽¹⁾	$I_F = 7.5\text{A}, T_J = 25^\circ\text{C}$	V_F	0.93	-	V
	$I_F = 15\text{A}, T_J = 25^\circ\text{C}$		1.00	1.10	V
	$I_F = 7.5\text{A}, T_J = 125^\circ\text{C}$		0.82	-	V
	$I_F = 15\text{A}, T_J = 125^\circ\text{C}$		0.92	-	V
Reverse current @ rated V_R per diode ⁽²⁾	$T_J = 25^\circ\text{C}$	I_R	-	5	μA
	$T_J = 125^\circ\text{C}$		-	500	μA
Junction capacitance per diode	1MHz, $V_R = 4.0\text{V}$	C_J	79	-	pF

Notes:

1. Pulse test with $PW = 0.3\text{ms}$
2. Pulse test with $PW = 30\text{ms}$

ORDERING INFORMATION		
ORDERING CODE⁽¹⁾	PACKAGE	PACKING
GBU150x	GBU	20 / Tube

Notes:

1. "x" defines voltage from 600V(GBU1505) to 1000V(GBU1507)

CHARACTERISTICS CURVES

($T_A = 25^\circ\text{C}$ unless otherwise noted)

Fig.1 Forward Current Derating Curve

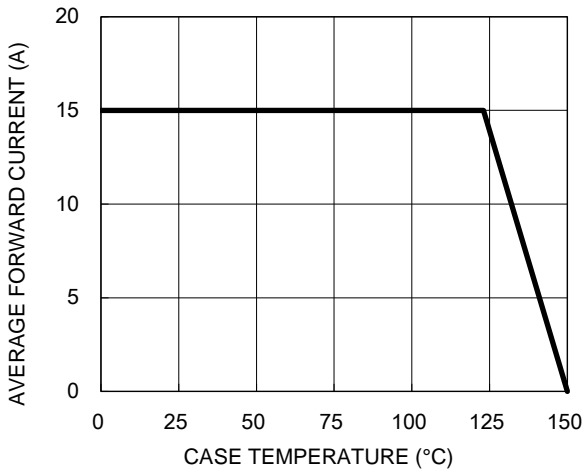

Fig.2 Typical Junction Capacitance

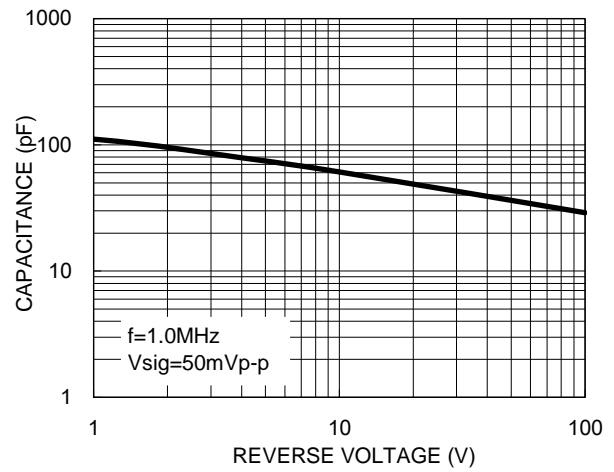

Fig.3 Typical Reverse Characteristics

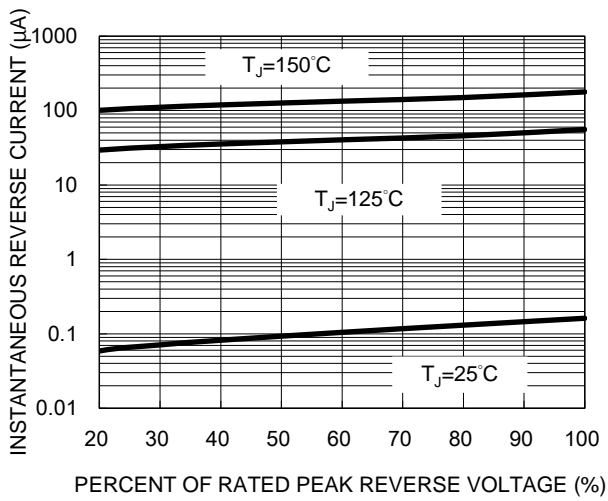
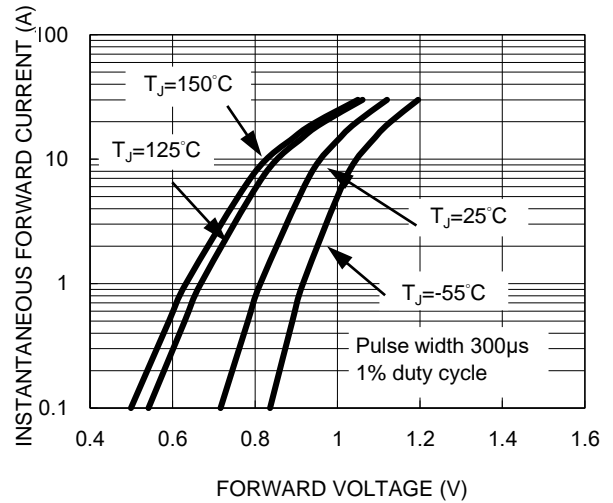
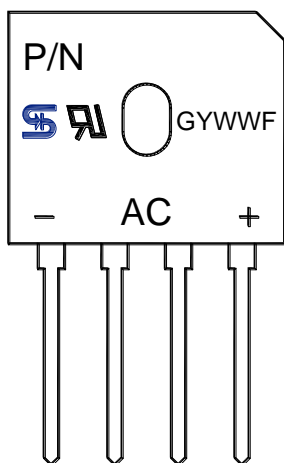
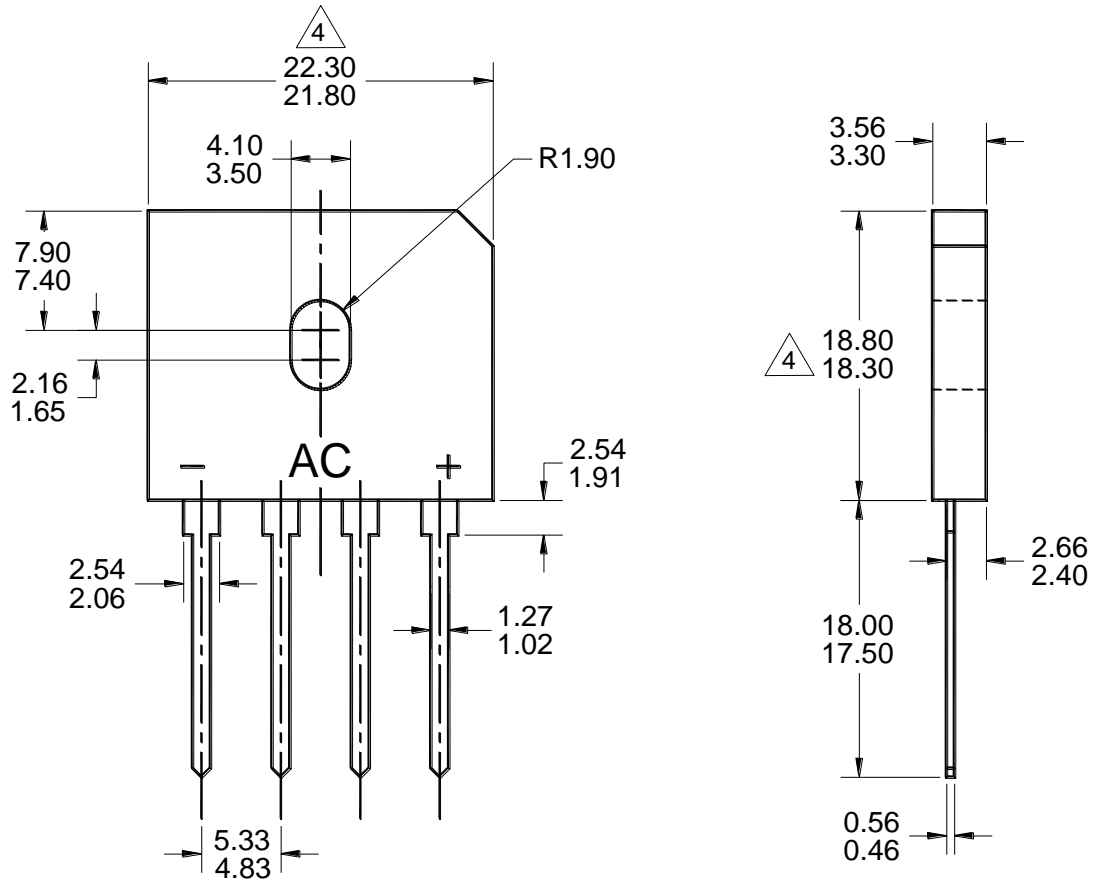

Fig.4 Typical Forward Characteristics



PACKAGE OUTLINE DIMENSIONS

GBU



MARKING DIAGRAM

P/N = MARKING CODE
 G = GREEN COMPOUND
 YWW = DATE CODE
 F = FACTORY CODE

NOTES: UNLESS OTHERWISE SPECIFIED

1. ALL DIMENSIONS ARE IN MILLIMETERS.
2. DIMENSIONING AND TOLERANCING PER ASME Y14.5M-1994.
3. THERE IS NO EXISTING PACKAGE OUTLINE INDUSTRY STANDARD FOR THIS PACKAGE.
4.  MOLDED PLASTIC BODY DIMENSIONS DO NOT INCLUDE MOLD FLASH, PROTRUSIONS OR GATE BURRS.
5. DWG NO. REF: HQ2SD07-GBUK-102 REV A.

Notice

Specifications of the products displayed herein are subject to change without notice. TSC or anyone on its behalf, assumes no responsibility or liability for any errors or inaccuracies.

Purchasers are solely responsible for the choice, selection, and use of TSC products and TSC assumes no liability for application assistance or the design of Purchasers' products.

Information contained herein is intended to provide a product description only. No license, express or implied, to any intellectual property rights is granted by this document. Except as provided in TSC's terms and conditions of sale for such products, TSC assumes no liability whatsoever, and disclaims any express or implied warranty, relating to sale and/or use of TSC products including liability or warranties relating to fitness for a particular purpose, merchantability, or infringement of any patent, copyright, or other intellectual property right.

The products shown herein are not designed for use in medical, life-saving, or life-sustaining applications. Customers using or selling these products for use in such applications do so at their own risk and agree to fully indemnify TSC for any damages resulting from such improper use or sale.