

1A, 50V - 1000V High Efficient Bridge Rectifier

FEATURES

- AEC-Q101 qualified available
- Ideal for printed circuit board
- Reliable low cost construction utilizing molded plastic technique
- High surge current capability
- UL Recognized File # E-326854
- Moisture sensitivity level: level 1, per J-STD-020
- RoHS Compliant
- Halogen-free according to IEC 61249-2-21

APPLICATIONS

- Switching mode power supply (SMPS)
- Adapters
- Lighting application

MECHANICAL DATA

- Case: DBLS
- Molding compound meets UL 94V-0 flammability rating
- Terminal: Matte tin plated leads, solderable per J-STD-002
- Meet JESD 201 class 2 whisker test
- Polarity: As marked
- Weight: 0.360g (approximately)

KEY PARAMETERS		
PARAMETER	VALUE	UNIT
I_F	1	A
V_{RRM}	50 - 1000	V
I_{FSM}	50	A
$T_{J\ MAX}$	150	°C
Package	DBLS	
Configuration	Quad	



DBLS

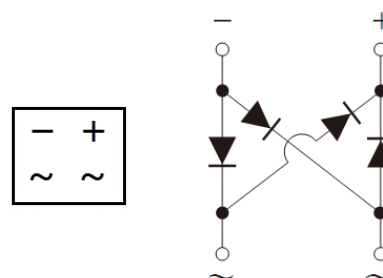

ABSOLUTE MAXIMUM RATINGS ($T_A = 25^\circ\text{C}$ unless otherwise noted)

PARAMETER	SYMBOL	HDBLS	HDBLS	HDBLS	HDBLS	HDBLS	HDBLS	HDBLS	UNIT
		101G	102G	103G	104G	105G	106G	107G	
Marking code on the device		HDBLS 101G	HDBLS 102G	HDBLS 103G	HDBLS 104G	HDBLS 105G	HDBLS 106G	HDBLS 107G	
Repetitive peak reverse voltage	V_{RRM}	50	100	200	400	600	800	1000	V
Reverse voltage, total rms value	$V_{R(RMS)}$	35	70	140	280	420	560	700	V
Forward current	I_F	1							A
Peak forward surge current, 8.3ms single half sine-wave superimposed on rated load	I_{FSM}	50							A
Rating for fusing ($t < 8.3\text{ms}$)	I^2t	10.3							A ² s
Junction temperature	T_J	- 55 to +150							°C
Storage temperature	T_{STG}	- 55 to +150							°C

THERMAL PERFORMANCE			
PARAMETER	SYMBOL	TYP	UNIT
Junction-to-lead thermal resistance	$R_{\theta JL}$	15	°C/W
Junction-to-ambient thermal resistance	$R_{\theta JA}$	40	°C/W

ELECTRICAL SPECIFICATIONS ($T_A = 25^\circ\text{C}$ unless otherwise noted)								
PARAMETER		CONDITIONS	SYMBOL	TYP	MAX	UNIT		
Forward voltage per diode ⁽¹⁾	HDBLS101G HDBLS102G HDBLS103G	$I_F = 1\text{A}, T_J = 25^\circ\text{C}$	V_F	-	1.0	V		
	HDBLS104G			-	1.3	V		
	HDBLS105G HDBLS106G HDBLS107G			-	1.7	V		
	Reverse current @ rated V_R per diode ⁽²⁾			$T_J = 25^\circ\text{C}$	I_R	-	5	μA
				$T_J = 125^\circ\text{C}$		-	500	μA
Reverse recovery time	HDBLS101G HDBLS102G HDBLS103G HDBLS104G	$I_F = 0.5\text{A}, I_R = 1.0\text{A},$ $I_{rr} = 0.25\text{A}$	t_{rr}	-	50	ns		
	HDBLS105G HDBLS106G HDBLS107G			-	75	ns		

Notes:

1. Pulse test with $PW = 0.3\text{ms}$
2. Pulse test with $PW = 30\text{ms}$

ORDERING INFORMATION		
ORDERING CODE ⁽¹⁾⁽²⁾	PACKAGE	PACKING
HDBLS1xG	DBLS	1,500 / Tape & Reel
HDBLS1xGH	DBLS	1,500 / Tape & Reel

Notes:

1. "x" defines voltage from 50V(HDBLS101G) to 1000V(HDBLS107G)
2. "H" means AEC-Q101 qualified

CHARACTERISTICS CURVES

($T_A = 25^\circ\text{C}$ unless otherwise noted)

Fig.1 Forward Current Derating Curve

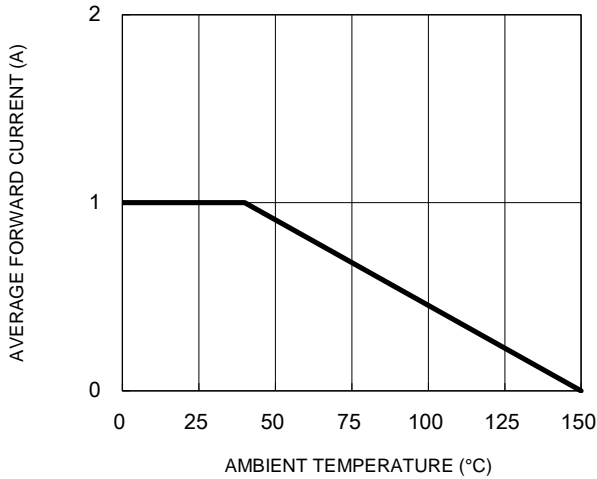

Fig.2 Typical Junction Capacitance

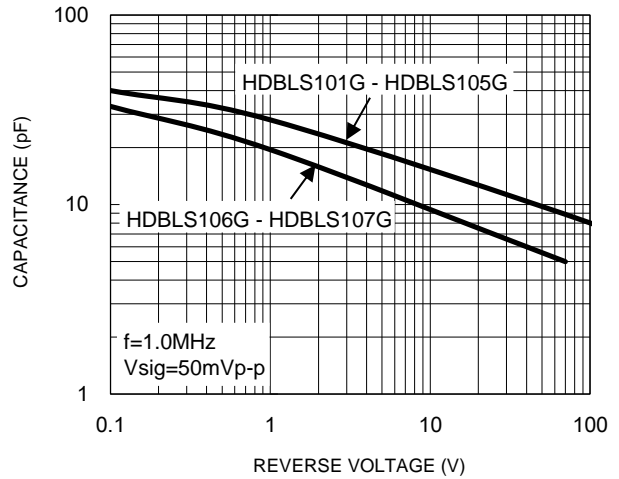

Fig.3 Typical Reverse Characteristics

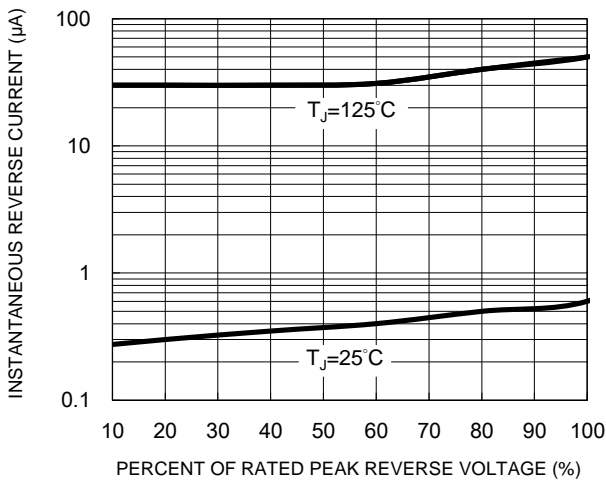

Fig.4 Typical Forward Characteristics

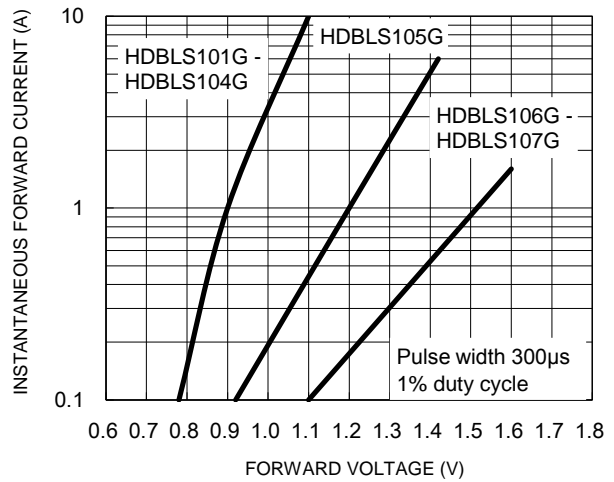
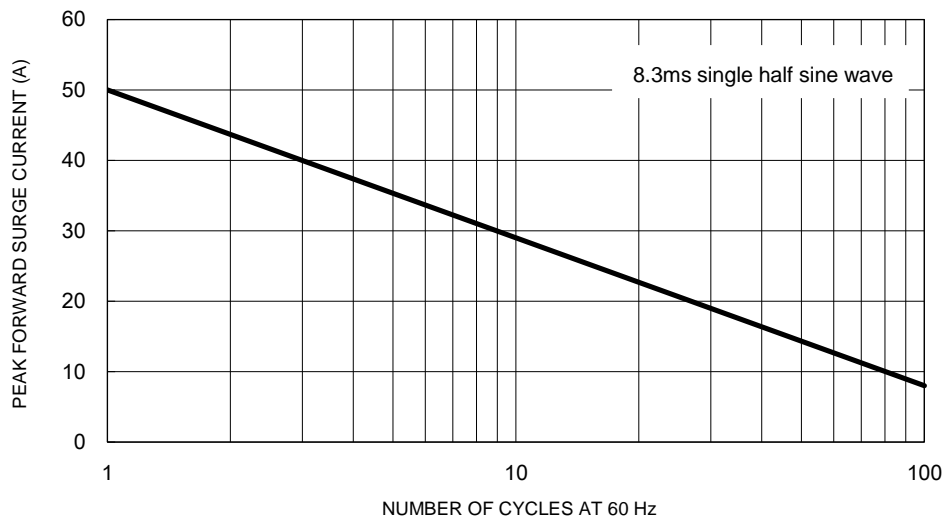

Fig.5 Maximum Non-Repetitive Forward Surge Current



CHARACTERISTICS CURVES

(T_A = 25°C unless otherwise noted)

Fig.6 Reverse Recovery Time Characteristic and Test Circuit Diagram



PACKAGE OUTLINE DIMENSIONS

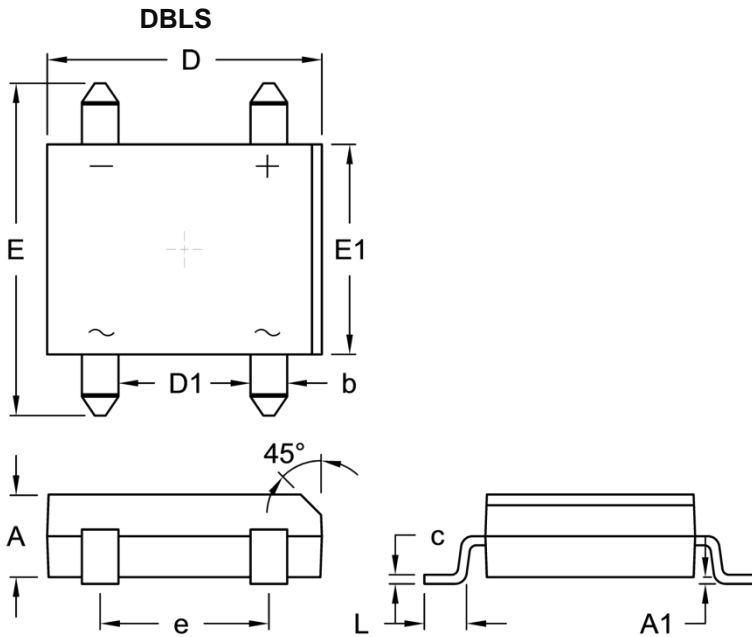

DIM.	Unit (mm)		Unit (inch)	
	Min.	Max.	Min.	Max.
A	2.40	2.60	0.094	0.102
A1	0.076	0.330	0.003	0.013
b	1.02	1.20	0.040	0.047
c	0.22	0.33	0.009	0.013
D	8.13	8.51	0.320	0.335
D1	3.90	4.10	0.154	0.161
E	9.80	10.30	0.386	0.406
E1	6.20	6.50	0.244	0.256
e	5.00	5.20	0.197	0.205
L	1.02	1.53	0.040	0.060

SUGGESTED PAD LAYOUT

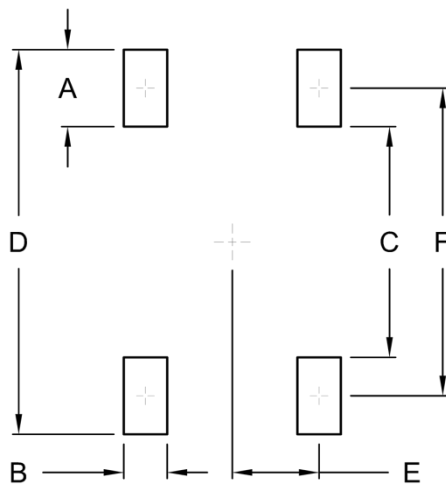

Symbol	Unit (mm)	Unit (inch)
A	2.30	0.091
B	1.30	0.051
C	6.90	0.272
D	11.50	0.453
E	2.60	0.102
F	9.20	0.362

MARKING DIAGRAM



- P/N = Marking Code
- G = Green Compound
- YW = Date Code
- F = Factory Code

Notice

Specifications of the products displayed herein are subject to change without notice. TSC or anyone on its behalf, assumes no responsibility or liability for any errors or inaccuracies.

Purchasers are solely responsible for the choice, selection, and use of TSC products and TSC assumes no liability for application assistance or the design of Purchasers' products.

Information contained herein is intended to provide a product description only. No license, express or implied, to any intellectual property rights is granted by this document. Except as provided in TSC's terms and conditions of sale for such products, TSC assumes no liability whatsoever, and disclaims any express or implied warranty, relating to sale and/or use of TSC products including liability or warranties relating to fitness for a particular purpose, merchantability, or infringement of any patent, copyright, or other intellectual property right.

The products shown herein are not designed for use in medical, life-saving, or life-sustaining applications. Customers using or selling these products for use in such applications do so at their own risk and agree to fully indemnify TSC for any damages resulting from such improper use or sale.