



### ■ Features

- DALI device type 6(DT6) and device type 8(DT8) available
- Constant power mode output with 2 channels
- Plastic housing with class II and PFC design
- Flick free, complying with IEEE1789
- Standby power consumption <0.5W
- Minimum dimming level 0.2%
- Cooling by free air convection
- Emergency lighting (EL) available
- 5 years warranty

### ■ Applications

- Tunable White Lighting
- Human Centric Lighting(HCL)
- Downlight
- Panel Light
- Decorative Light
- Commercial Lighting
- DALI digital Lighting

### ■ GTIN CODE

MW Search: <https://www.meanwell.com/serviceGTIN.aspx>

### ■ Description

LCM-40TW Series is a 40W constant power output LED driver with two channels output for Tunable white function. It can operate from 180~277V AC and output current ranging between 500 mA to 1050 mA selectable by dip switch. Thanks to high efficiency up to 87%, it is able to operate for -30°C~85°C case temperature under free air convection. LCM-40TW is designed based on DALI-2 DT8 Tunable white and is also usable as two independent output channels with DT6 function. LCM-40TW can be adjusted for light intensity and color temperature by a push button as a simple way dimming, so it provides the design flexibility for LED Lighting application.

### ■ Model Encoding

LCM - 40 TW

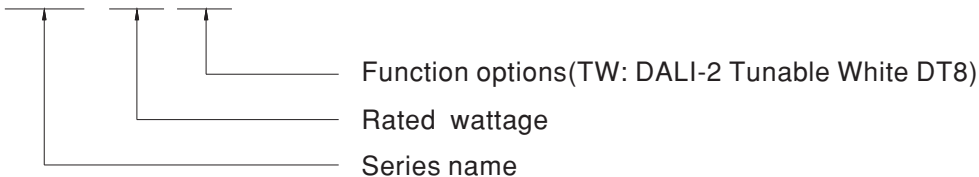



**SPECIFICATION**

MODEL		LCM-40TW	
OUTPUT	OUTPUT CHANNEL	CH1	CH2
	DC VOLTAGE RANGE	20~50V	20~50V
	NO LOAD VOLTAGE	53V	53V
	DEFAULT CURRENT	700mA	700mA
	CURRENT ADJ. RANGE (BY DIP SWITCH)	500~1050mA	500~1050mA
	RATED POWER	40W Max. total	
	CURRENT RIPPLE <small>Note5</small>	<2%	
	DIMMING RANGE	0~100%	
	START UP TIME <small>Note9</small>	500ms/230VAC	
INPUT	VOLTAGE RANGE	180~277VAC	260~390VDC
	FREQUENCY RANGE	47 ~ 63Hz	
	POWER FACTOR	PF≥0.98/230VAC, PF≥0.95/277VAC@full load (Please refer to "POWER FACTOR (PF) CHARACTERISTIC" section)	
	TOTAL HARMONIC DISTORTION	THD < 10% (@load 50%/230VAC; @load 75%/277VAC) (Please refer to "TOTAL HARMONIC DISTORTION(THD)" section)	
	EFFICIENCY(Typ.) <small>Note4</small>	87%	
	AC CURRENT	0.23A/230VAC	
	INRUSH CURRENT	COLD START 20A(twidth=310μs measured at 50% Ipeak) at 230VAC; Per NEMA 410	
	LEAKAGE CURRENT	<0.75mA / 277VAC	
	STANDBY POWER CONSUMPTION <small>Note6</small>	standby power consumption<0.5W (Dimming off)	
PROTECTION	OVERLOAD	105~135% rated output power Protection type: Hiccup mode, recovers automatically after fault condition is removed.	
	SHORT CIRCUIT	Constant current limiting, recovers automatically after fault condition is removed	
	OVER TEMPERATURE	Stage 1: Derating to 70% loading; stage2: Shut down. Recovers automatically after fault condition is removed	
ENVIRONMENT	WORKING TEMP.	Tcase=-30~85℃ (Please refer to "OUTPUT LOAD vs TEMPERATURE" section)	
	MAX. CASE TEMP.	Tcase=85℃	
	WORKING HUMIDITY	20 ~ 90% RH non-condensing	
	STORAGE TEMP., HUMIDITY	-40 ~ +80℃, 10 ~ 95% RH	
	TEMP. COEFFICIENT	±0.03%/℃ (0 ~ 50℃)	
	VIBRATION	10 ~ 500Hz, 2G 10min./1cycle, period for 60min. each along X, Y, Z axes	
	OPERATING ALTITUDE	2000 meters	
SAFETY&EMC	SAFETY STANDARDS	ENEC BS EN/EN61347-1, BS EN/EN61347-2-13(EL) appendix J suitable for emergency installations; BS EN/EN62384 independent, GB19510.14, GB19510.1, EAC TP TC 004 approved;	
	DALI STANDARDS	Comply with IEC62386-101, 102, 207(DT6),209(DT8),251	
	WITHSTAND VOLTAGE	I/P-O/P:3.75KVAC	
	ISOLATION RESISTANCE	I/P-O/P:>100M Ohms / 500VDC / 25℃ / 70% RH	
	EMC EMISSION	Compliance to BS EN/EN55015, BS EN/EN61000-3-2 Class C(@load 50%) ; BS EN/EN61000-3-3; GB17625.1,GB17743,	
	EMC IMMUNITY	Compliance to BS EN/EN61000-4-2,3,4,5,6,8,11, BS EN/EN61547, light industry level(surge immunity Line-Line 2KV), EAC	
OTHERS	MTBF	2111.7K hrs min. Telcordia SR-332 (Bellcore)	177.4Khrs min. MIL-HDBK-217F (25℃)
	DIMENSION	123.5*81.5*23mm (L*W*H)	
	PACKING	0.24Kg ; 54pcs/15Kg/1.12CUFT	
NOTE	<ol style="list-style-type: none"> <li>All parameters NOT specially mentioned are measured at 230VAC input, rated current and 25℃ of ambient temperature.</li> <li>De-rating may be needed under low input voltages. Please refer to "STATIC CHARACTERISTIC" sections for details.</li> <li>Length of set up time is measured at first cold start. Turning ON/OFF the driver may lead to increase of the set up time.</li> <li>Efficiency is measured at 800mA/50V output set by DIP switch.</li> <li>Current ripple is measured 50%~100% of maximum voltage under rated power delivery.</li> <li>Standby power consumption is measured at 180-230VAC.</li> <li>The driver is considered as a component that will be operated in combination with final equipment. Since EMC performance will be affected by the complete installation, the final equipment manufacturers must re-qualify EMC Directive on the complete installation again.</li> <li>The ambient temperature derating of 3.5℃/1000m with fanless models and of 5℃/1000m with fan models for operating altitude higher than 2000m(6500ft).</li> <li>Based on IEC 62386-101/102 DALI power on timing and interruption regulations, the set up time needs to test with a DALI controller which can support for DALI power on function, otherwise the start up time will be higher than 0.5 second.</li> <li>For more information, please contact with MEAN WELL sales.</li> </ol> <p>※ Product Liability Disclaimer : For detailed information, please refer to <a href="https://www.meanwell.com/serviceDisclaimer.aspx">https://www.meanwell.com/serviceDisclaimer.aspx</a></p>		

### ■ BLOCK DIAGRAM

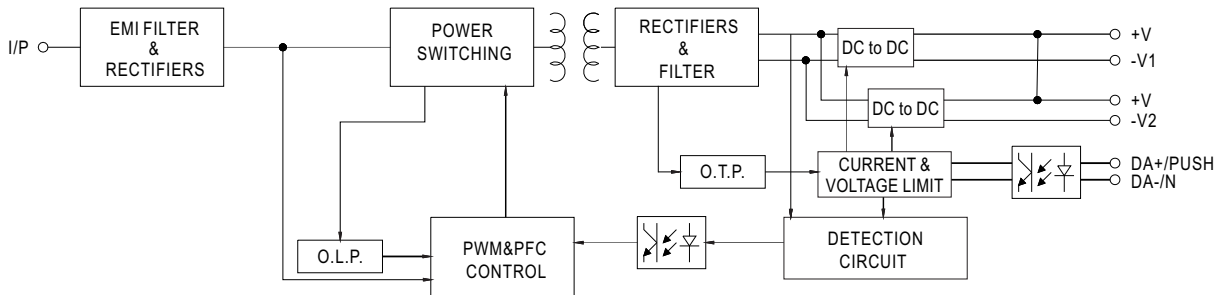

### ■ DRIVING METHODS OF LED MODULE

※ I-V Operating Area

◎ LCM-40TW

For 40W application

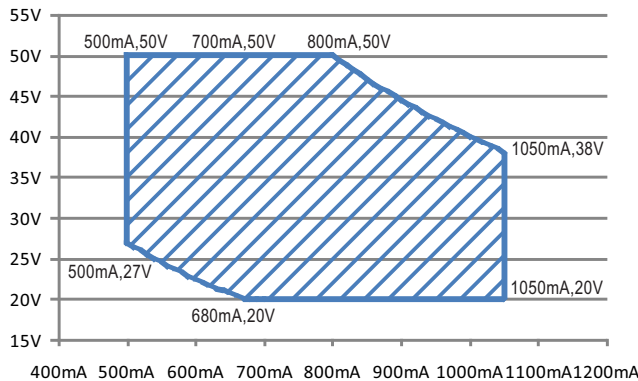

### ■ DIP SWITCH TABLE

LCM-40TW is a multiple-stage constant power driver, selection of output current through DIP switch is exhibited below.

Vo	Io	DIP S.W		
		1	2	3
27~50V	500mA	----	ON	ON
		ON	ON	ON
25~50V	600mA	----	----	ON
		ON	----	ON
20~50V	700mA(factory default)	ON	ON	----
20~50V	800mA	----	ON	----
20~44V	900mA	ON	----	----
20~38V	1050mA	----	----	----

Status	DIP S.W		Activated Channel
	4	5	
Single-address DT6	----	ON	CH1
Dual-address DT6	ON	ON	CH1,CH2
Single-address DT8 (factory default)	----	----	CH1,CH2
	ON	----	

Note: 1. For more current setting, please contact MW's sales.  
2. The operating voltage range which show on this table is recommend to use.

**■ DIMMING OPERATION**

※ Output wiring diagram

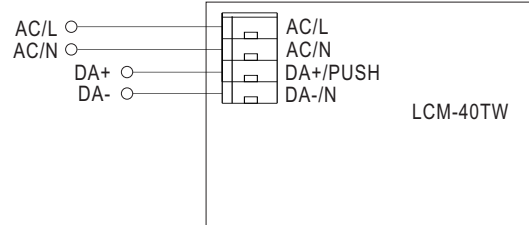
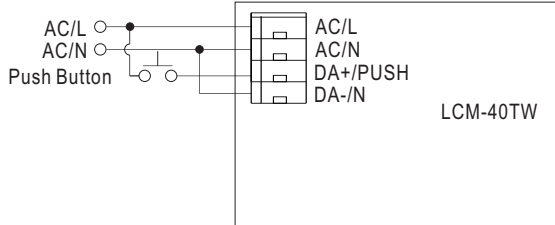

※ PUSH dimming (primary side)

- The factory default dimming level is at 100%.
- If the push action lasts less than 0.05 sec., it will not lead to a change for the status of the driver.
- Up to 10 drivers can perform the PUSH dimming at the same time when utilizing one common push button.
- The maximum length of the cable from the push button to the last driver is 20 meters.

Action	Action duration
Short Push	0.1~1s
Double Click	Click twice in 1.5s
Long Push	1.5~10s

**PUSH dimming functions table**

Status	Output	Push button function
DT6 (Single Address)	CH1	Short Push : ON/OFF Double Click : go to maximum. Long Push : Dim up/down. - dim up stop at maximum; dim down stop at min dim (not dim off) - with next push, direction change (up/down) - dim up possible even if when unit is in standby mode (dim off mode)
DT6 (Dual Address)	CH1,CH2	Short Push: ON/OFF Double Click : go to maximum. Long Push : Dim up+CCT cooler/Dim down+CCT warmer - dim up stop at maximum; dim down stop at min dim (not dim off) - with next push, direction change (up/down) - dim up possible even if when unit is in standby mode (dim off mode)
DT8 (Single Address)	CH1(C.W.), CH2(W.W.)	Short Push : ON/OFF Double Click : Switch between Dim control or CCT control mode Long Push : Dim up/down or CCT control - dim up stop at maximum; dim down stop at min dim (not dim off) - with next push, direction change (up/down, warm/cold) - dim up possible even if when unit is in standby mode (dim off mode)

**■ DIMMING CURVE**

Dimming characteristics

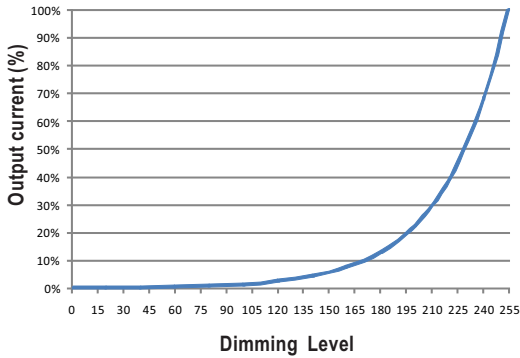

Dynamic range in colour temperature control

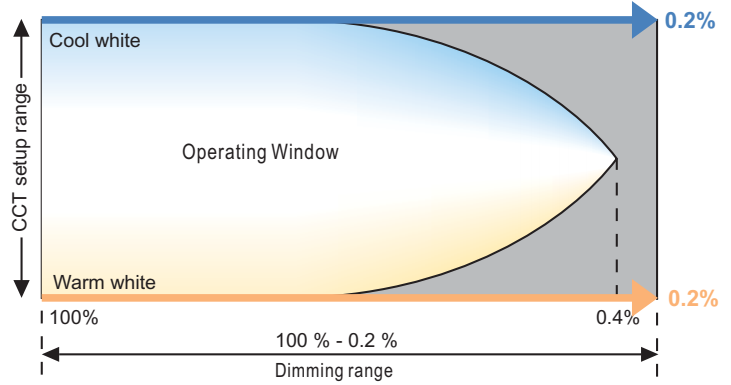

**■ OUTPUT CONNECTIONS**

Application	Output channels	Output connections schematic diagram
One channel output control(DT6)	Single address	
Two channels output control(DT6)	Dual address	
Tunable white control(DT8)	Single address	

**■ OUTPUT LOAD vs TEMPERATURE**

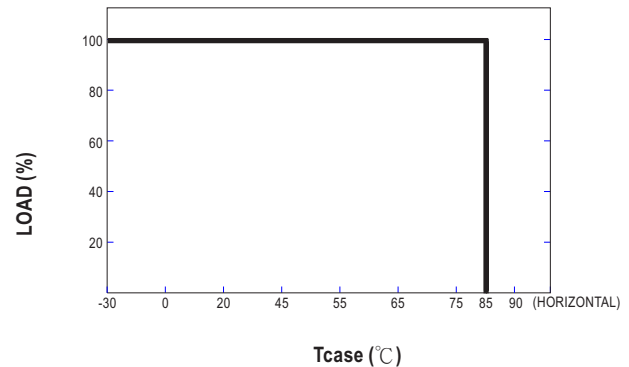
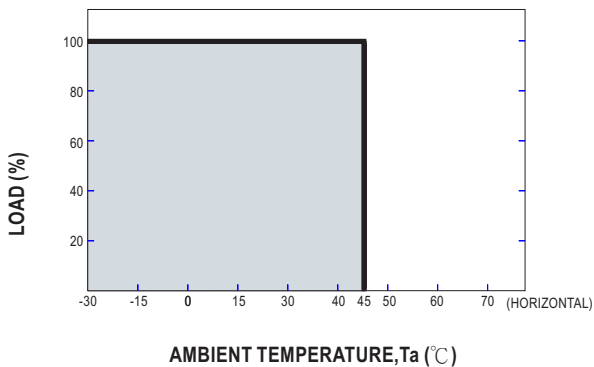

**■ STATIC CHARACTERISTIC**

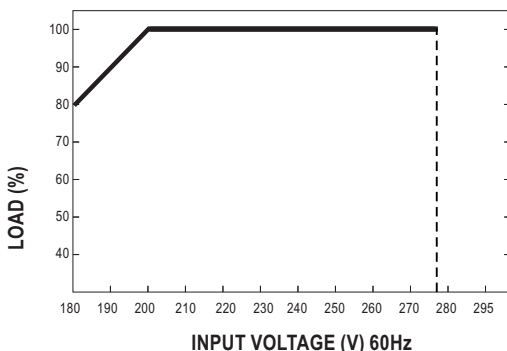

※ De-rating is needed under low input voltage.

### TOTAL HARMONIC DISTORTION (THD)

※ Tcase at 85°C

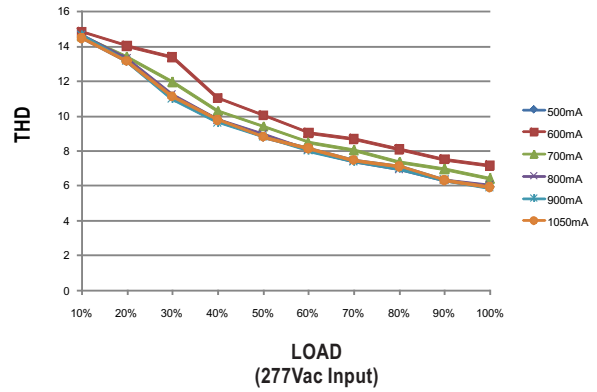
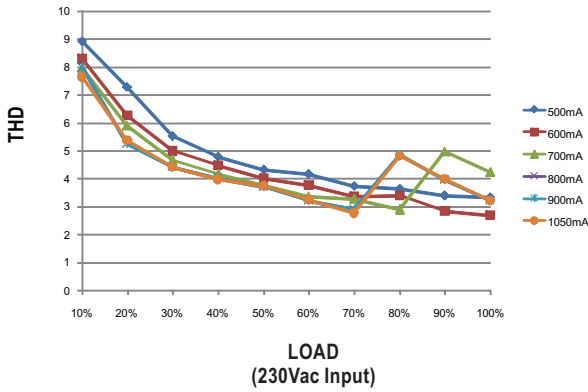

### POWER FACTOR (PF) CHARACTERISTIC

※ Tcase at 85°C

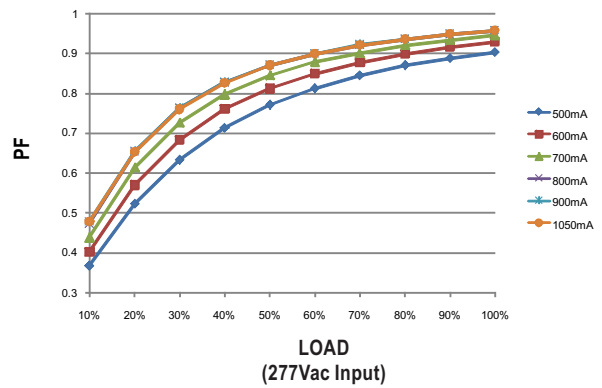
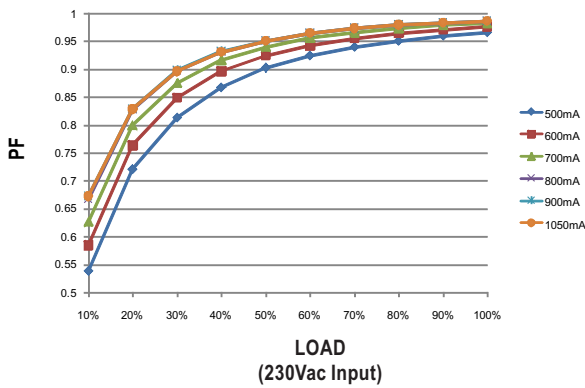

### EFFICIENCY vs LOAD

LCM-40TW series possess superior working efficiency that up to 87% can be reached in field applications.

※ Tcase at 85°C

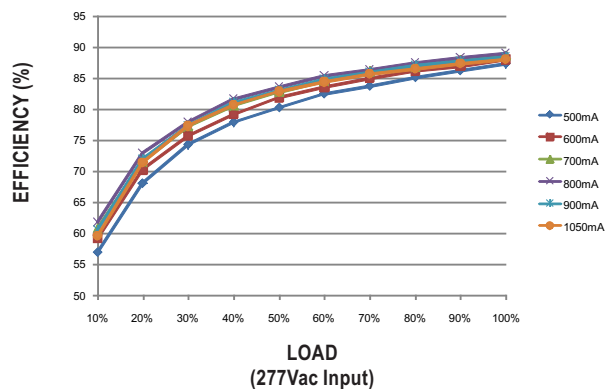
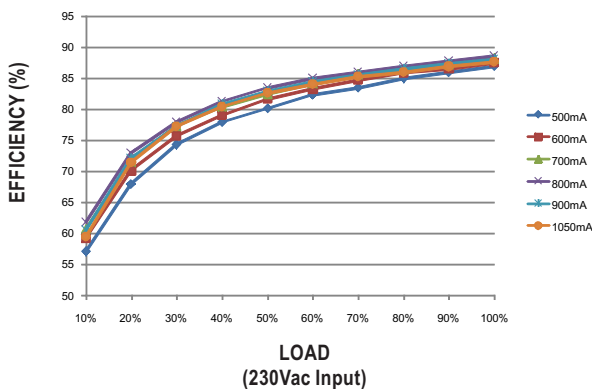

## MECHANICAL SPECIFICATION

Case No.LCM-60A Unit:mm

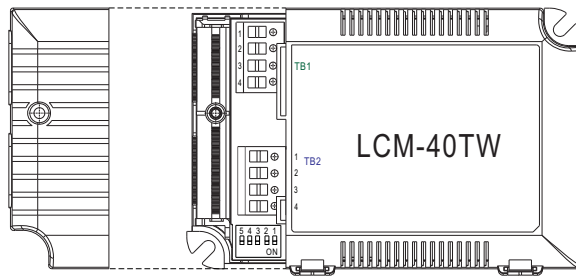
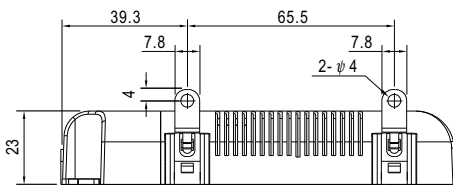
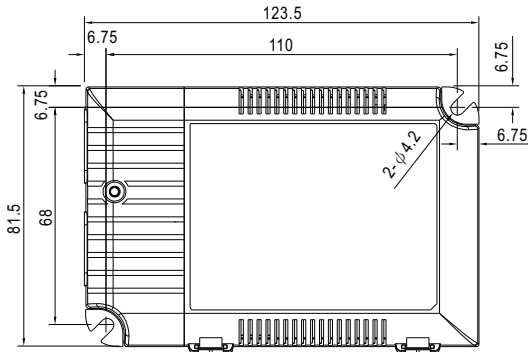

※ Terminal Pin No. Assignment(TB1)

Pin No.	Assignment
1	AC/L
2	AC/N
3	DA+/PUSH
4	DA-/N

※ Terminal Pin No. Assignment(TB2)

Pin No.	Assignment
1	+V
2	+V
3	-V1(C.W.)
4	-V2(W.W.)

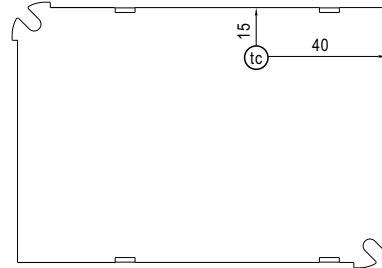

Bottom View

• (tc) : Max. Case Temperature

## Installation Manual

Please refer to : <http://www.meanwell.com/manual.html>