

LPF67A68 Pin Fin LED Cooler ϕ 67mm

Features & Benefits

- For spot and downlight designs from 1,100 to 3,300 lumen
- Thermal resistance Rth 2.1°C/W
- Diameter 67mm - Height 68mm
Other heights on request
- Standard base thickness 8 mm
Other base thicknesses on request
- Easy base plate customisation with mounting holes, cable guidance, reflector mounting options,...
- Better performance under tilted positions compared to extruded LED heat sinks
- Cable guidance side slot
- Forged from highly conductive aluminum with 83 round pins for maximum cooling surface
- Standard colors black anodised - clear anodised



Order Information

Thermal Interface Material

Please make sure to apply a high thermal conductive material between the heat sink base and the LED engine with an applied thickness between 0.1mm and 0.2mm

Advised materials:

- **Thermally Conductive Grease**
High performance, more difficult to apply and control the thickness
Example Laird Technologies Tgrease 880
- **Thermal Gap Filler Pad with electrical insulation**
Medium to high performance, easy to apply
Example Laird Technologies Tgard 500-A1
- **Phase Change Thermal Interface Material**
This material applies like a thermal pad but becomes fluid and creates a perfect wetting at the first heating cycle
Extra high performance, easy to apply
Example Laird Technologies TPCM 585

Not using a suitable thermal conductive material will lead to either an insufficient wetting area or a high thermal resistance between LED engine and heat sink base both immediately resulting in an extra temperature increase of the LED junction

We do not advise the use of double sided thermal tapes without using extra mounting screws to create pressure

Thermal gap filler pads and phase change pads can be pre-applied by MechaTronix with specific cutting designs

Example: LPF67A68-8-B

LPF67 **1** **2** - **3** - **4**

- 1** Mechanical version
A] Solid base
B] Center hole ϕ 11.5mm
C] 3*M3 mounting hole
D] Center hole ϕ 11.5mm + 3*M3 mounting hole
XX] Customised
- 2** Height (pins+base) (mm)
68 or customised
- 3** Base thickness (mm)
8 or customised
- 4** Anodising color
B – Black
C – Clear
customised painting colors on request

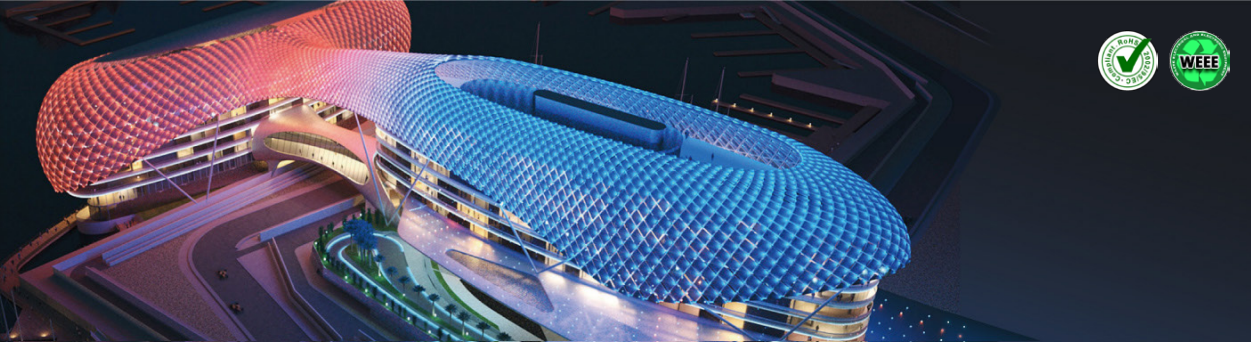

LPF67A68 Pin Fin LED Cooler ø67mm

Product Details



Model n°	LPF67A68
Dimension (mm) ^{*1}	ø67 x h68
Volume (mm ³)	64026
Cooling Surface (mm ²)	54924
Weight (gr)	172
Thermal Resistance (°C/W) ^{*2}	2.1
Power Pd (W) ^{*3}	24
Heat Sink Material	AL1070

*1 3D files are available in ParaSolid, STP and IGS on request

*2 The thermal resistance Rth is determined with a calibrated heat source of 30mm x 30mm central placed on the heat sink, Tamb 40° and an open environment.

Reference data @ heat sink to ambient temperature rise Ths-amb 50°C

The thermal resistance of a LED cooler is not a fix value and will vary with the applied dissipated power Pd

*3 Dissipated power Pd. Reference data @ heat sink to ambient temperature rise Ths-amb 50°C

The maximal dissipated power needs to be verified in function of required case temperature Tc or junction temperature Tj and related to the estimated ambient temperature where the light fixture will be placed

Please be aware the dissipated power Pd is not the same as the electrical power Pe of a LED module

To calculate the dissipated power please use the following formula: $Pd = Pe \times (1 - \eta L)$

Pd - Dissipated power

Pe - Electrical power

ηL = Light efficiency of the LED module

Notes:

- MechaTronix reserves the right to change products or specifications without prior notice.
- Mentioned models are an extraction of full product range.
- For specific mechanical adaptations please contact MechaTronix.

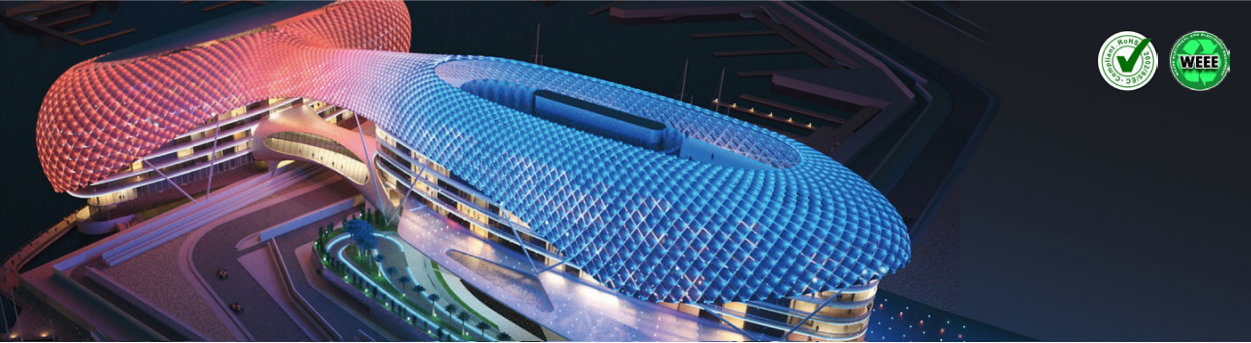

LPF67A68 Pin Fin LED Cooler $\phi 67$ mm

Drawings & Dimensions

Example: LPF67A68-8

Unit: mm

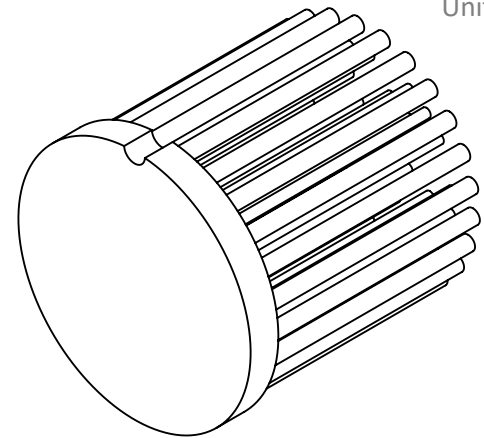
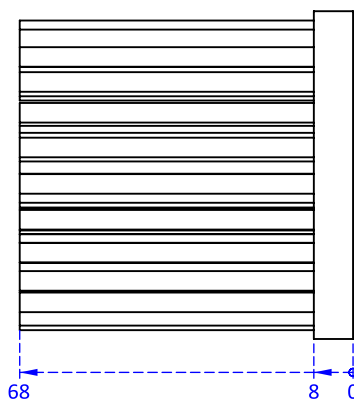
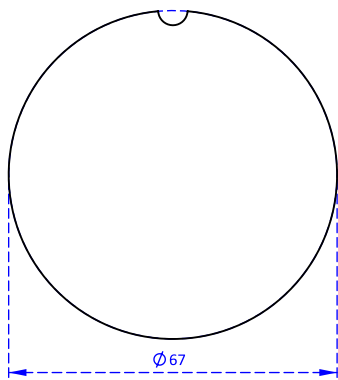

A Mechanical version
 Solid base



B Mechanical version
 Center hole
 $\phi 11.5$ mm



C Mechanical version
 3*M3 mounting hole

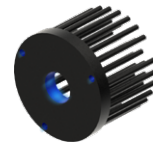

D Mechanical version
 Center hole
 $\phi 11.5$ mm + 3*M3 mounting hole

Mechanical version A is the standard model and is kept in stock for fast sample delivery or adaptation to your needs
 Afterwork on this stock model will be done by CNC what results in non-anodised holes and areas - average lead time for afterwork 2 weeks
 Mechanical versions B/C/D are for illustration only to show possible mechanical adaptations and are not related to any specific brand or model outline design and mounting pattern - MOQ for these models is 1000pcs from production with lead time 6 weeks
 Please see also the standard available brand specific LED Pin Fin heat sinks under the related brands

Examples of customised pin fin heat sinks:



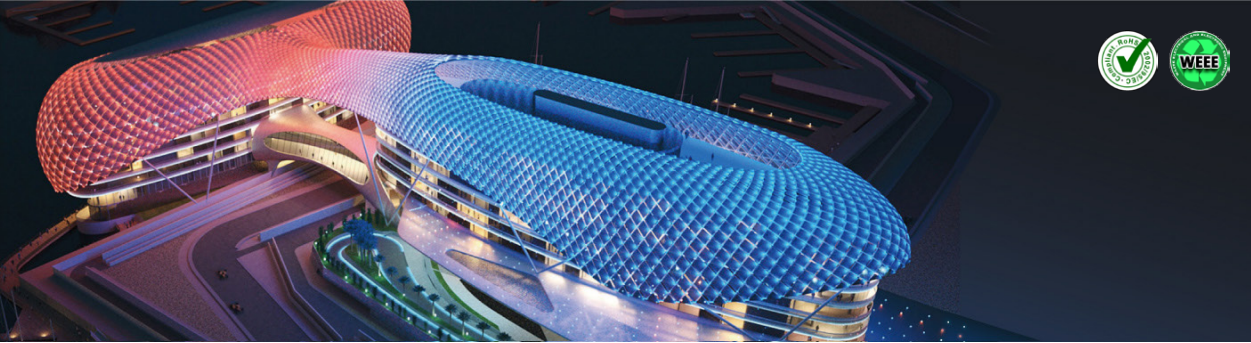

LPF67A68 Pin Fin LED Cooler ø67mm

Thermal Data

The thermal performance of a LED cooler, expressed as Thermal Resistance R_{th} in K/W (or °C/W) tells you how many degrees Kelvin (or Celsius) the base of the LED cooler will incline per Watt of dissipated power P_d .

This dissipated power P_d is the heat loss a LED package or LED COB/LOB will create besides the efficient light generation.

Typically for white LED packages the efficiency varies with the color CCT and the CRI – values here below can be taken as a rule of thumb for white LED packages (phosphor corrected blue light)

CCT 4000 - 7000 and CRI 70 - 80 → 35% efficiency → 65% heat loss

CCT 2700 - 3000 and CRI 85 - 97 → 30% efficiency → 70% heat loss

For other LED packages like horticulture specific wave lengths or UV, we recommend you to look up the thermal efficiency in the datasheet or contact the supplier.

Keep in mind that for horticulture LED packages, example 660nm Deep Red, the thermal losses are drastically lower and can be as low as 40%, meaning you could almost use double the electrical power P_e on the same LED cooler for the same temperature rise ΔT .

Next the Thermal Resistance R_{th} is not a fix value – the nominal value we declare corresponds with a 50°C temperature rise – The table below explains the thermal resistance R_{th} for various dissipated power values.

In this way you can completely predict the temperature you are going to get in your LED luminaire.

Difficulties figuring it out – just let us know and our engineers will do the math for you.

$P_d = P_e \times (1 - \eta_L)$			LED Light efficiency, η_L (%)			Heat sink to ambient thermal resistance R_{hs-amb} (°C/W)	Heat sink to ambient temperature rise T_{hs-amb} (°C)
			17%	20%	25%	LPF67A68	LPF67A68
Dissipated Power P_d (W)	3	Electrical Power P_e (W)	3.61	3.75	4.0	3.0	9
	5		6.02	6.25	6.67	2.8	14
	10		12.04	12.5	13.33	2.5	25
	15		18.07	18.75	20.0	2.3	35
	20		24.10	25.0	26.67	2.2	44
	25		30.12	31.25	33.33	2.1	53

Heat sink to ambient temperature rise T_{hs-amb} (°C)

— LPF67A68

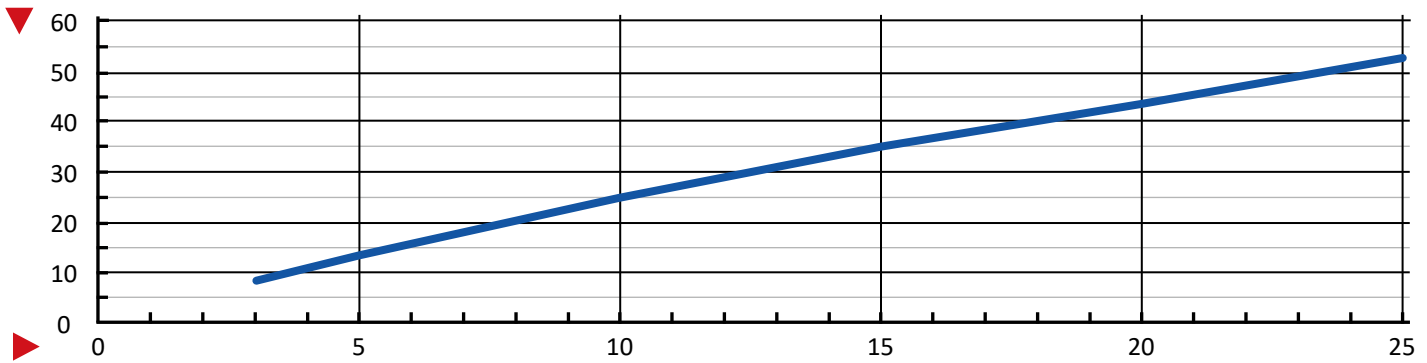

Dissipated Power P_d (W)