

SPECIFICATION



LIAN DUNG

ELECTRIC WIRE MATERIAL CO., LTD

聯東電線材料股份有限公司

APPROVED

台灣台中市豐原區三豐路二段 515-16 號

No.515-16, Sec.2, Sanfeng Rd., Fengyuan Dist.,

Taichung City 420, Taiwan

TEL : 886-4-25270346 FAX : 886-4-25270348

http : //www.liandung.com.tw

E-mail : liandung@liandung.com.tw

客戶名稱 : (CUSTOMER NAME)

Schukat electronic Vertriebs GmbH

客戶料號 : (CUSTOMER PART NO.)

PLUG : LT-G067

CORD : SPT-1 2X18AWG105D BLK 0.5m

ISSUE : LD-QA-1080451

DATE : APR-29-2019

核		審		製	曾 群 閱
准		核		表	

1.Scope:

This specification defines the requirements for SPT-1、SPT-2、SPT-3 power cord for NORTH AMERICAN use.

2.Reference Publication:

UL 62 & 817.

CSA C22.2 No.49-06 & No.21-95

3.Construction:

3.1 Plug: Catalogue No. LT-G067 (UL/CSA TYPE) ; UL File No. E 187738

3.2 Connector: NA

3.3 Flexible cord manufacturerl:

● WU LI

● I-SHENG

3.4.Flexible Cord:

Types	Conductor			Core	Insulation Thickness mm	Jacket Thickness mm	Overall Diameter mm	Rating			
	AWG	mm ²	No./mm					Voltage V	Temp. °C	Current A	
SPT-1	18	0.81	41/0.16	2	--	0.76	2.70*5.40	300	60.105	10	★
	18	0.81	41/0.16	3	0.33	0.76	2.75*7.48	300	60.105	10	
SPT-2	18	0.81	41/0.16	2	--	1.14	3.40*6.80	300	60.105	10	
	16	1.31	26/0.253	2	--	1.14	3.60*7.20	300	60.105	13	
SPT-2	18	0.81	41/0.16	3	0.35	1.14	3.70*8.60	300	60.105	10	
	16	1.31	26/0.253	3	0.35	1.14	3.60*10.10	300	60.105	13	
SPT-3	18	0.81	40/0.16	2	--	1.52	4.2*8.4	300	60.105	10	
	16	1.31	26/0.253	2	--	1.52	4.5*9.0	300	60.105	13	
	14	2.08	41/0.253	2	--	1.52	5.8*11.6	300	60.105	18	
SPT-3	18	0.81	41/0.16	3	0.35	1.52	4.2*11.0	300	60.105	10	
	16	1.31	26/0.253	3	0.35	1.52	4.5*11.8	300	60.105	13	
	14	2.08	41/0.253	3	0.35	1.52	5.8*14.1	300	60.105	18	

4.Characteristics:

4.1 Continuity:

Each cord set or power supply cord shall be tested for its acceptance for electrical continuity.

4.2 Polarity:

In each cord set or power supply cord a blade or a terminal which is identified for the connection of live or neutral or grounding conductor shall be connected to the corresponding identified conductor of the wire.

4.3 Dielectric Voltage-Withstand:

Each cord set or power supply cord shall be capable of withstanding application of a 60HZ potential of 1250 volts between.

- a) Any two conductors, and
- b) live parts and dead metal parts

for one minute without breakdown.

4.4 Insulation Resistance:

The insulation resistance of a fitting between :

- a) Live parts of opposite polarity,
- b) Live parts and dead metal parts, and
- c) Live parts and any surface insulating material

Shall not be less than 100 megohms DC 500V.

4.5 Security of Blades:

Each blade of attachment plug shall be capable of withstand a pull of 20 pounds for two minutes without loosening or causing a residual displacement of more than 2.4mm.

4.6 Conductor Secureness:

Each blade of contact after being connected to a conductor prior to molding, the joint shall be capable of withstanding a pull force for one minute without breaking. The applied force shall be 20 pounds when the conductor is 18AWG or larger in size. The pull force shall be 8 pounds when a smaller conductor is used.

4.7 Temperature Rise Test:

With the application of 12A current to samples for 1 hour. The temperature rise shall not exceed 45°C against room temperature.

4.8 Blade Pull Test at Elevated Temperature:

The blade of a molded-on attachment plug shall be capable of withstanding a pull force 10 pounds at a temperature of 60°C for 4 hours without being pulled out from the molded body.

4.9 Flexing Test:

Each cord set or power supply cord shall be capable of withstanding 2500 cycles of bending as described in UL 817 paragraph 77.

4.10 Abrupt Pull Test:

Each cord set or power supply cord shall be capable of resistant to physical abuse so as to acceptably withstand the test described in UL817 paragraph 83.

4.11 Withdrawal Force Test:

Inserted the connector into appliance inlet and withdraw the connector.

While measuring the strength shall be 1kg~6kg.

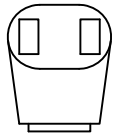
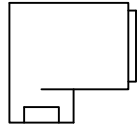
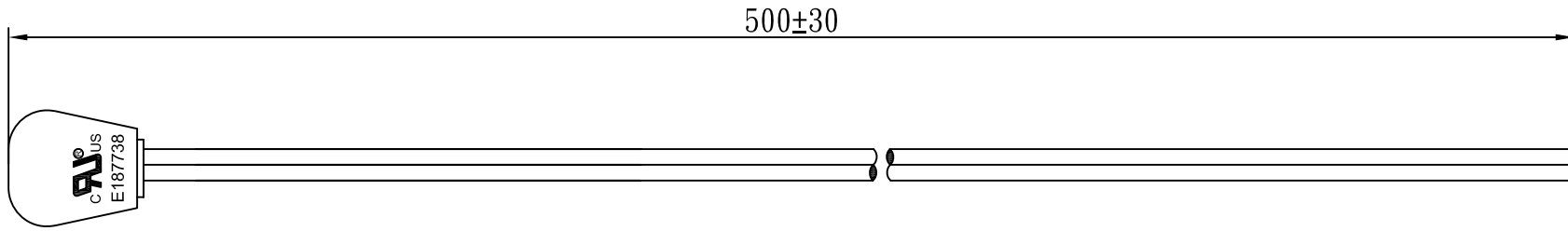

NOTE :

1. CORD : SPT-1 18AWG/2C 105D BLK 0.5m
2. CUSTOMER : Schukat electronic Vertriebs GmbH
3. Supplier for flexible cord : I-SHENG、WU LI
4. P/N : N/A

3.			DRAWER	Qunmin	DATE	19/04/29	TITLE	LT-G067
2.			APPROVE		REV.	1	Dr.No.	1080451
1.				比例			TOL.	±5mm
PART	DESCRIPTION	DATE				ALL DIMENSIONS IN mm		



LIAN DUNG
ELECTRIC WIRE MATERIAL CO.,LTD.
 聯東電線材料股份有限公司

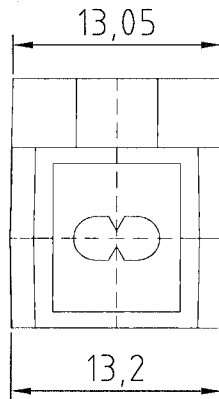
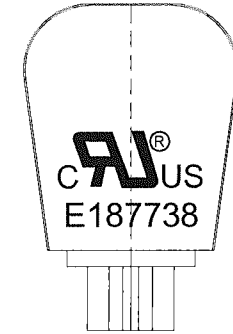
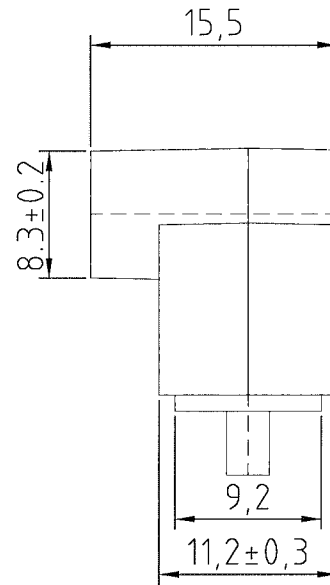
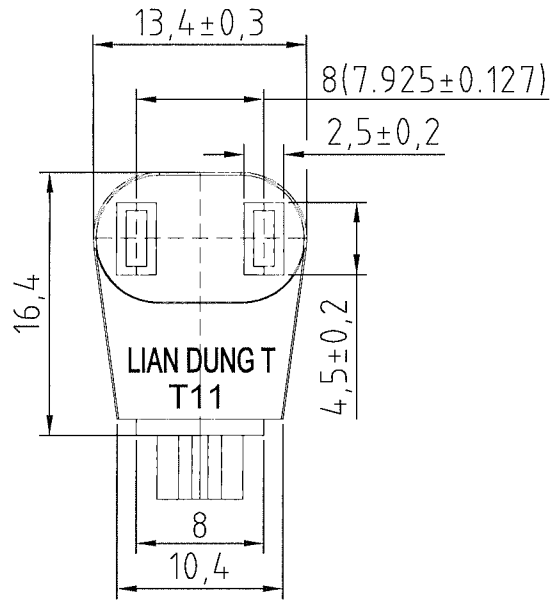

PART	DESCRIPTION	DATE	DRAWER	王俊堯	DATE	18/07/25	TITLE	LT-G067
1.			APPROVE	林明宗	REV.	4	Dr.No.	CG06701
2.				比例	1:1	TOL.	±0.8mm	
3.		ALL DIMENSIONS IN mm						



LIAN DUNG
ELECTRIC WIRE MATERIAL CO.,LTD.
聯東電線材料股份有限公司



ELBZ.E121791
Cord Sets and Power-supply Cords

[Page Bottom](#)

Cord Sets and Power-supply Cords

[See General Information for Cord Sets and Power-supply Cords](#)

LIAN DUNG ELECTRIC WIRE MATERIAL CO LTD

E121791

957-16 SAN FENG RD
FENG YUAN DISTRICT
TAICHUNG, 420 TAIWAN



Trademark and/or Tradename:

[Last Updated](#) on 2001-04-19

[Questions?](#)

[Print this page](#)

[Terms of Use](#)

[Page Top](#)

◆ 2016 UL LLC

The appearance of a company's name or product in this database does not in itself assure that products so identified have been manufactured under UL's Follow-Up Service. Only those products bearing the UL Mark should be considered to be Certified and covered under UL's Follow-Up Service. Always look for the Mark on the product.

UL permits the reproduction of the material contained in the Online Certification Directory subject to the following conditions: 1. The Guide Information, Assemblies, Constructions, Designs, Systems, and/or Certifications (files) must be presented in their entirety and in a non-misleading manner, without any manipulation of the data (or drawings). 2. The statement "Reprinted from the Online Certifications Directory with permission from UL" must appear adjacent to the extracted material. In addition, the reprinted material must include a copyright notice in the following format: "© 2016 UL LLC".

I N D E X

CAT. NO.	Electrical A/V	Section	Fig.	USR	CNR
LT-T018	20/48	1	1	YES	YES
LT-T019	20/48	2	1	YES	YES
LT-G053, 07100	10/125 or 5/250	3	1	YES	YES
LT-G067, 07190	10/125 or 5/250	3	2	YES	YES
LT-G068, 07199	10/125 or 5/250	3	3	YES	YES
LT-G069, 07145	10/125 or 5/250	3	4	YES	YES

Note - USR - United States Standard, Recognized Component.

CNR - Canadian National Standard, Recognized Component.

Cat. NO. LT-G067, 07190 - FIG. 2

General - The general design, shape and arrangement shall be as illustrated except where variations are specifically described. Cat. No. 07190 is identical to Cat. No. LT-G067 except for different model name.

Body - Molded PVC, R/C (QMFZ2/8), Cat. No. CS-9371-WBS, see File E177713, manufactured by CHIA SHIN ENTERPRISES CO LTD. See ILL. 3 for dimensional details.

Alternate Material - Molded PVC, R/C (QMFZ2/8), Cat. No. AH-85J, see File E134674, manufactured by RHYTHM WIRE INDUSTRIAL CO LTD.

Alternate Material - Molded PVC, R/C (QMFZ2/8), Cat. No. Flex 60G, manufactured by Pure Friend Business Enterprise Corp. (E174939)

Inner Body Assembly - Optional, two-piece construction. **Molded of PP, R/C (QMFZ2/8), Cat. No. 3317(f1), manufactured by NAN YA PLASTICS (HUI ZHOU) CORP LTD. (E235269) See ILLS. 6 and 7 for dimensional details.**

*

Contacts - Two provided, copper alloy, plated optional. Crimped to conductor with crimping length 2.4 mm and crimping height 1.4 mm for one flexible cord provided, crimping length 2.4 mm and crimping height 1.7 mm for two flexible cord provided. See ILL. 2 for dimensional details.

Cord - Flexible cord, Listed (ZJCZ/7). One or two provided. See the following table for application details.

<u>Cord Size</u>	<u>Cord Type</u>	<u>USL</u>	<u>CNL</u>
18/2 AWG	SPT-1	YES	YES

Alternate Cord - Flexible cord, Listed (ZJCZ/7). See the following table for application details. The grounding conductor terminates outside the body.

<u>Cord Size</u>	<u>Cord Type</u>	<u>USL</u>	<u>CNL</u>
18/3 AWG	SPT-1	YES	YES



ZJCZ.E94163
Flexible Cord

[Page Bottom](#)

Flexible Cord

[See General Information for Flexible Cord](#)

WU LI ELECTRIC WIRE & CABLE CO LTD

E94163

60 CHUNG-HWA RD, SEC 5
HSINCHU, 300 TAIWAN

Decorative cord, Type(s) CXTW, SPT-1W, SPT-2W, XTW

Jacketed cord, Type(s) SJT, SJT-R, SJTW, ST, STW, SVT, SVT-R

Parallel cord, Type(s) NISPT-1, NISPT-2, SPT-1, SPT-1-R, SPT-2, SPT-2-R, SPT-3



Trademark and/or Tradename: "E94163" , "LIAN DUNG" ,

[Last Updated](#) on 2013-06-13

[Questions?](#)

[Print this page](#)

[Terms of Use](#)

[Page Top](#)

© 2018 UL LLC

The appearance of a company's name or product in this database does not in itself assure that products so identified have been manufactured under UL's Follow-Up Service. Only those products bearing the UL Mark should be considered to be Certified and covered under UL's Follow-Up Service. Always look for the Mark on the product.

UL permits the reproduction of the material contained in the Online Certification Directory subject to the following conditions: 1. The Guide Information, Assemblies, Constructions, Designs, Systems, and/or Certifications (files) must be presented in their entirety and in a non-misleading manner, without any manipulation of the data (or drawings). 2. The statement "Reprinted from the Online Certifications Directory with permission from UL" must appear adjacent to the extracted material. In addition, the reprinted material must include a copyright notice in the following format: "© 2018 UL LLC".



PROFILE OF CERTIFICATION REPORTS

178 Rexdale Blvd. Rexdale (Toronto), Ontario M9W 1R3

NUMBR P85694X0000

FILE NO: LL 85694

SUBMITTOR

Wu Li Electric Wire & Cable Co.
60 Chung Hua Rd.
Section 5
Hsin-Chu, Taiwan
Attention: Mr. Y.Y. Chang
Fax: 88635 383138

Page No: CRP 1 of 1
Date: October 13, 1992
Replaces: August 28, 1992

FACTORY

Wu Li Electric Wire & Cable Co.
60 Chung Hua Rd.
Section 5
Hsin-Chu, Taiwan

INSPECTION OFFICE

Taiwan

FILE NO

LL 85694

REPORT NO-APPL. NO

-1

April 4, 1989 - Certification of
equipment wire Type TXF, 60C, 125V.

-2

January 3, 1991 - Flexible cord Type
SPT-1 (2 conductor construction) rated at
60C, FT2.

-3

January 30, 1991 - Flexible cord Type
SPT-1 (2 conductor) rated at 105C, FT2.

-4,-8

August 28, 1991 - Supplementary
certification of flexible cords Type
SPT-2 (2 conductor construction) rated
60C, 105C, FT2. In all colours except
clear and transparent.

-11, -12

October 13, 1992 - AWM, single conductor
construction with PVC insulation, Class
I, Group A/B, 80C, 105C, 300V, 600V,
FT1.

* * * * * * * * *bm



ZJCZ.E88265
Flexible Cord

[Page Bottom](#)

Flexible Cord

[See General Information for Flexible Cord](#)

I SHENG ELECTRIC WIRE & CABLE CO LTD

E88265

52 TIN HWU RD
TA GANN VILLAGE
GWAI SAN HSIAN, TAOYUAN HSIEN 333 TAIWAN

Clock cord, Type(s) Clock

Decorative cord, Type(s) CXTW, SPT-1W, SPT-2W, XTW

Dryer and range cord, Type(s) SRDT

Heater cord, Type(s) HPN

Jacketed cord, Type(s) S, SJ, SJO, SJOO, SJOOW, SJOW, SJT, SJT-R, SJTO, SJTW, SO, SOO, SOOW, SOW, ST, STO, STOW, STW, SV, SVO, SVOO, SVT, SVT-R

Parallel cord, Type(s) NISPT-1, NISPT-2, SPT-1, SPT-2, SPT-2-R, SPT-3

Trademark and/or Tradename: "CERROWIRE"

[Last Updated](#) on 2013-09-26

[Questions?](#)

[Print this page](#)

[Terms of Use](#)

[Page Top](#)

© 2018 UL LLC

The appearance of a company's name or product in this database does not in itself assure that products so identified have been manufactured under UL's Follow-Up Service. Only those products bearing the UL Mark should be considered to be Certified and covered under UL's Follow-Up Service. Always look for the Mark on the product.

UL permits the reproduction of the material contained in the Online Certification Directory subject to the following conditions: 1. The Guide Information, Assemblies, Constructions, Designs, Systems, and/or Certifications (files) must be presented in their entirety and in a non-misleading manner, without any manipulation of the data (or drawings). 2. The statement "Reprinted from the Online Certifications Directory with permission from UL" must appear adjacent to the extracted material. In addition, the reprinted material must include a copyright notice in the following format: "© 2018 UL LLC".



Certification Record

CUSTOMER	CLASS	FILE
I-Sheng Electric Wire & Cable Co., Ltd. No 52 Tin Hwu Rd, Ta Gann Village Gwai San Hsian Taoyuan Hsien 33334 Taiwan	<u>5831-01</u> WIRES-Flexible Cord Refer to Class Description for program details	081924_0_000

TO THE REQUIREMENTS OF CSA STANDARD C22.2 NO 49-06:

Type	Max Volt (V)	Size of Conductors (AWG*)	No of Conductors	Insul. Type	Jacket Type	Notes
• Max temperature rating 60C:						
SPT-1	300	20,18	2,3	PVC	-	1,2,3
NISPT-1	300	20,18	2,3	PVC	PVC	1,2,6
SPT-2	300	18,16	2,3	PVC	-	1,2,3
NISPT-2	300	18,16	2,3	PVC	PVC	1,2,6
SPT-3	300	18-10	2,3	PVC	-	1, 2
SVT	300	18,17,16	2,3	PVC	PVC	1,2,4
SJT	300	18-10	2-6	PVC	PVC	1,2,4
SJTO	300	18-10	2-6	PVC	PVC	1,2
SJTW, SJTOW	300	18-10	2-6	PVC	PVC	1,2,4,5
ST	600	18-2	2 or more	PVC	PVC	1,2,4
STW, STOW	600	18-2	2 or more	PVC	PVC	1,2,4,5
PXT	125	20	2	PVC	-	1,2,7
PXWT	300	18, 16	2	PVC	-	1,2,5,7
S	600	18-2	2 or more	EP	CPE	1,2,7
SO	600	18-2	2 or more	EP	CPE	1,2,7
SOO	600	18-2	2 or more	EP	CPE	1,2,7
SOW	600	18-2	2 or more	EP	CPE	1,2,7
SOOW	600	18-2	2 or more	EP	CPE	1,2,7
SJ	300	18-10	2-6	EP	CPE	1,2,7
SJO	300	18-10	2-6	EP	CPE	1,2,7
SJOO	300	18-10	2-6	EP	CPE	1,2,7
SV	300	18,17,16	2 or 3	EP	CPE	1,2,7
SVO	300	18,17,16	2 or 3	EP	CPE	1,2,7
SVOO	300	18,17,16	2 or 3	EP	CPE	1,2,7

• Max temperature 90C:

HPN	300	14	2	CPE	-	1,2
SV	300	18, 17, 16	2 or 3	EP	CPE	1, 2, 7
SVO	300	18, 17, 16	2 or 3	EP	CPE	1, 2, 7
SVOO	300	18, 17, 16	2 or 3	EP	CPE	1, 2, 7
HPN	300	16, 18	2 or 3	CPE	-	1, 2, 8

• Max temperature 105C:

SPT-1	300	20,18	2,3	PVC	-	1,2,3
NISPT-1	300	20,18	2,3	PVC	PVC	1,2,6
SPT-2	300	18,16	2,3	PVC	-	1,2,3
NISPT-2	300	18,16	2,3	PVC	PVC	1,2,6
SPT-3	300	18-10	2,3	PVC	-	1, 2
SVT	300	18,17,16	2,3	PVC	PVC	1,2,4
SJT	300	18-10	2-6	PVC	PVC	1,2,4
SJTO	300	18-10	2-6	PVC	PVC	1,2
SJTW, SJTOW	300	18-10	2-6	PVC	PVC	1,2,4,5
ST	600	18-2	2 or more	PVC	PVC	1,2,4
STW, STOW	600	18-2	2 or more	PVC	PVC	1,2,4,5
HPN	300	14	2	CPE	-	1,2
HPN	300	16, 18	2 or 3	CPE	-	1,2,8
S	600	18-2	2 or more	EP	CPE	1,2,7
SO	600	18-2	2 or more	EP	CPE	1,2,7
SOO	600	18-2	2 or more	EP	CPE	1,2,7
SOW	600	18-2	2 or more	EP	CPE	1,2,7
SOOW	600	18-2	2 or more	EP	CPE	1,2,7
SJ	300	18-10	2-6	EP	CPE	1,2,7
SJO	300	18-10	2-6	EP	CPE	1,2,7
SJOO	300	18-10	2-6	EP	CPE	1,2,7
HPN						

*mm² sizes also apply.

Notes:

1. In all colours except for clear and translucent.
2. Flame classification - FT2.
3. Includes two-conductor constructions in clear or translucent.
4. Optional shielding.
5. Low temperature rating: -40C.
6. Non-integral construction.
7. Flame classification - FT1.
8. HPN with 16 or 18 AWG, 3 conductor, EP ground conductor insulation.