



# SCHUKAT

electronic

*Your Reliable Power Partner*



**High Performance & Compact Design**  
**Configurable Power Supply**

*450W~1200W Modular Series*



# Company Profile

Established in 1982, MEAN WELL is a leading standard switching power supply manufacturers in the world.

MEAN WELL currently operates under five companies in Taiwan, China, USA and Europe and three factories in Taiwan, GuangZhou and SuZhou. The product lines include AC/DC switching power supplies, DC/DC converters, waterproof LED drivers, adaptors, DC/AC inverters and battery chargers. We have over 9,500 standard models widely used in medical, automation, communication, LED lighting, moving sign, and office automation fields.

With more than 30 years of experience in R&D and production of standard power supplies, MEAN WELL has ten product categories covering 9,500 models, to provide "One Stop Shopping" power solutions. Every product in MEAN WELL is the result of rigid procedures governing design, design verification test (DVT), design quality test (DQT), component selection, pilot-run production, and mass production.

With more than 200 distributors globally, the MEAN WELL products are distributed to over 80 countries worldwide. The small size orders can expect delivery within 24 hours without MOQ requirement. If you are looking for switching power supply with high reliability, good quality, reasonable price and full series products, MEAN WELL, a total solution provider which can satisfy your various demands, is definitely your first choice!



MEAN WELL USA



MEAN WELL EUROPE



MEAN WELL TAIWAN

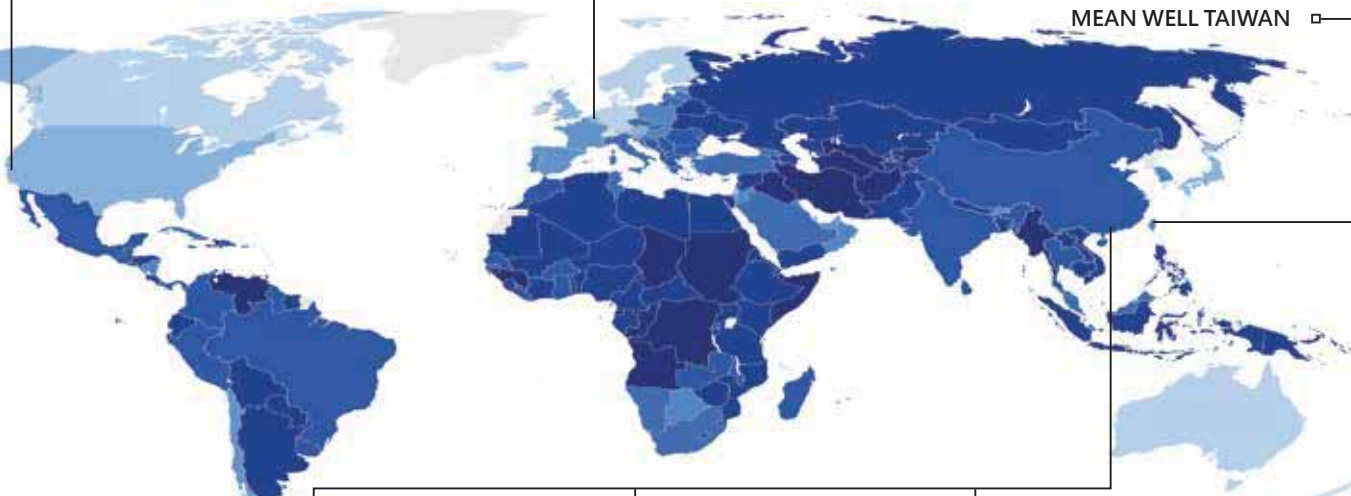

MEAN WELL SUZHOU



MEAN WELL GUANGZHOU  
TIANHE R&D CENTER



MEAN WELL GUANGZHOU  
HUADU FACTORY





## 2xMOPP Introduction

MOPP stands for Mean of Patient Protection. It is the latest requirement as per 60601-1 3rd edition. 2xMOPP means PSU with double insulation (DI) between Primary and Secondary sides and 1xMOPP between Primary to protective earth (FG) at normal condition. Shown as figure below. PSU with 2xMOPP can be implemented on almost **ALL** medical devices!

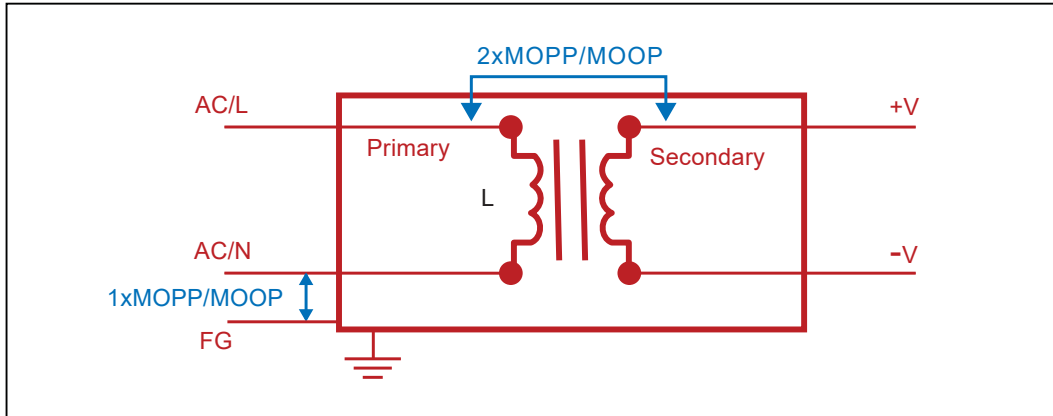

## BF rated devices

Type BF (body floating) is generally used for applied parts that have conductive contact with the patient, or have medium or long term contact with the patient. Examples of this type of equipment are ultrasound scanner, blood pressure monitors, incubators and etc...



# NMP Series

650W/1200W Intelligent Medical Modular Power Supply



## Configurable

- Cover 3 to 55Vdc output range
- Modules can be in Parallel or Serial connection

## Medical Applications

- 60601-1 Ed. 3 certified
- Touch current < 100µA/264Vac

## Intelligent Control

- Global & Local remote ON/OFF control
- DC OK signal
- T-Alarm (OT Warning signal for OTP)

## Output Programmable

- PV range 50-100%
- PC range 40-100%

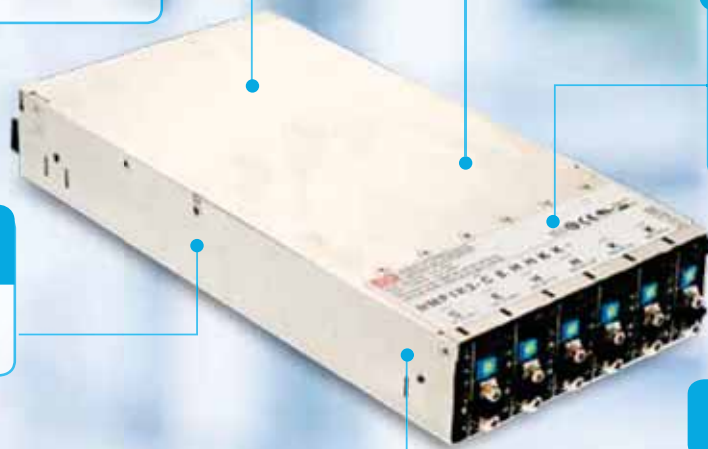

## Others

- 90~264VAC
- Working temp.: -30~70°C
- Built-in DC fan
- 5 years warranty

Series Connection

Parallel Connection

Front View



## Output Configuration Guide

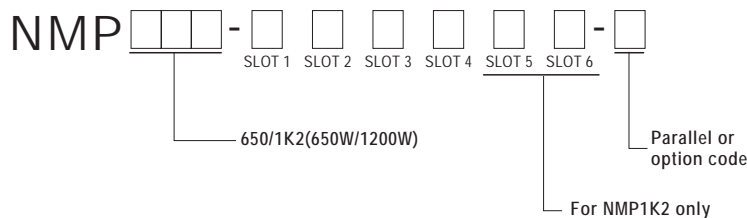

NMP Series SPEC

■ MS-240 : 1-SLOT isolated single output (240W max.)

Picture	Item Code	Output	Vdc adj.	Tol.	R&N.	Max.
	C	5V, 0~36A	3~6V	±2%	100mV	180W
	E	12V, 0~20A	6~15V	±1%	150mV	240W
	H	24V, 0~10A	15~30V	±1%	150mV	240W
	K	48V, 0~5A	30~55V	±1%	250mV	240W





X-ray and Image Diagnostic Machine



Automation Robot Arms

## NMP Series Accessory

### Parallel Connection Accessory

<p><b>FAP-009</b> (for NMS-240, 2 units)</p>	<p><b>FAP-010</b> (for NMS-240, 3 units)</p>

<p><b>NMS-240-P2/P3/P4/P5/P6</b> (to parallel NMS-240 in 2/3/4/5/6 modules)</p>

### Series Connection Accessory

<p><b>FAS-001</b> (for 1-slot modules: NMS-240)</p>

### Blank Plate Accessory

<p><b>BLANK-NMS240</b></p>



Medical Equipment MRI Scanner



Telecommunication

# MP Series

450W/650W/1000W Modular Power



## Industrial Applications

IEC/EN/UL 60950 certified

## Output Adjustable

PV range  $\pm 5\%$

## Remote Control

Remote ON/OFF control on single power module

## Others

- 85~264VAC
- Protection: SCP, OLP, and fan fail alarm
- Cooling by build-in DC fan
- 3 years warranty

## Configurable

- Cover 1.6 to 53Vdc output range with total 57 output modules
- Modules can be in Parallel or Serial connection



## Output Configuration Guide

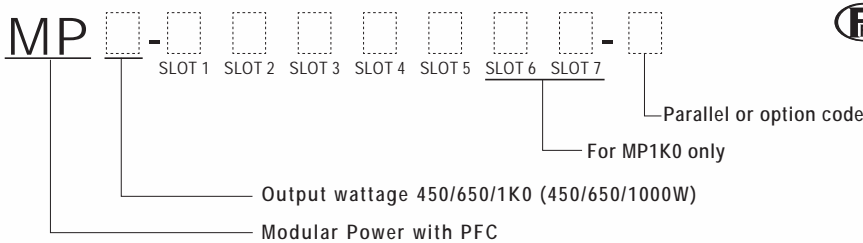

MP Series SPEC

## MP Series Accessory

### Parallel Connection Accessory

FAP-001	FAP-002	FAP-003	FAP-004
FAP-005	FAP-006	FAP-007	FAP-008

### Series Connection Accessory

FAS-001	FAS-002	FAS-003	FAS-004





Color Offset  
Printing Machine



Industrial Power Panel



■ MS-75 : 1-SLOT single output (75W max.)



Item Code	L	M	N	O	P	Q
Output	3.3V, 0~15A	5V, 0~15A	12V, 0~6.3A	15V, 0~5.0A	24V, 0~3.2A	48V, 0~1.6A
Vdc adj.	2.6~4.0V	4.0~6.0V	9.0~13.2V	13.2~16.8V	20.0~26.4V	40.0~53.0V

■ MS-150 : 1-SLOT single output (150W max.)



Item Code	A	B	C	D	E	F	G	H	I	J	K
Output	2V, 0~25A	3.3V, 0~25A	5V, 0~25A	7.5V, 0~18A	12V, 0~13A	15V, 0~10A	18V, 0~8.5A	24V, 0~6.5A	27V, 0~5.8A	33V, 0~4.7A	48V, 0~3.2A
Vdc adj.	1.6~2.6V	2.6~4.0V	4.0~6.0V	6.0~9.0V	9.0~13.2V	13.2~16.8V	16.8~20.0V	20.0~26.4V	25.0~31.0V	30.0~40.0V	40.0~53.0V

■ MS-210 : 1-SLOT parallelable single output (210W max.)

※Parallel function up to 5 units



Item Code	1A	1B	1C	1D	1E	1F	1G	1H	1I	1J	1K
Output	2V, 0~35A	3.3V, 0~35A	5V, 0~35A	7.5V, 0~28A	12V, 0~17.5A	15V, 0~14A	18V, 0~11.6A	24V, 0~8.75A	27V, 0~7.8A	33V, 0~6.4A	48V, 0~4.4A
Vdc adj.	1.6~2.6V	2.6~4.0V	4.0~6.0V	6.0~9.0V	9.0~13.2V	13.2~16.8V	16.8~20.0V	20.0~26.4V	25.0~31.0V	30.0~40.0V	40.0~53.0V

■ MS-300 : 2-SLOT parallelable single output (300W max.)

※Parallel function up to 3 units



Item Code	2A	2B	2C	2D	2E	2F	2G	2H	2I	2J	2K
Output	2V, 0~50A	3.3V, 0~50A	5V, 0~50A	7.5V, 0~40A	12V, 0~25A	15V, 0~20A	18V, 0~16.7A	24V, 0~12.5A	27V, 0~11.2A	33V, 0~9.1A	48V, 0~6.3A
Vdc adj.	1.6~2.6V	2.6~4.0V	4.0~6.0V	6.0~9.0V	9.0~13.2V	13.2~16.8V	16.8~20.0V	20.0~26.4V	25.0~31.0V	30.0~40.0V	40.0~53.0V

■ MS-360 : 2-SLOT parallelable single output (360W max.)

※Parallel function up to 3 units



Item Code	3A	3B	3C	3D	3E	3F	3G	3H	3I	3J	3K
Output	2V, 0~60A	3.3V, 0~60A	5V, 0~60A	7.5V, 0~48A	12V, 0~30A	15V, 0~24A	18V, 0~20A	24V, 0~15A	27V, 0~13.4A	33V, 0~11A	48V, 0~7.5A
Vdc adj.	1.6~2.6V	2.6~4.0V	4.0~6.0V	6.0~9.0V	9.0~13.2V	13.2~16.8V	16.8~20.0V	20.0~26.4V	25.0~31.0V	30.0~40.0V	40.0~53.0V

■ MD-100 : 1-SLOT isolated dual output (100W max.)



Item Code	R	S	T	U	V	W	X
Output	5V, 2.0~10A 5V, 0.0~8.0A	5V, 2.0~10A 12V, 0.0~5.8A	5V, 2.0~10A 15V, 0.0~4.7A	24V, 0.5~3.0A 5V, 0.0~10A	24V, 0.6~3.0A 12V, 0.0~4.7A	12V, 1.0~5.0A 12V, 0.0~5.8A	15V, 1.0~4.7A 15V, 0.0~4.7A
Vdc adj.	4.75~5.5V 4.75~5.5V	4.75~5.5V 11.4~13.2V	4.75~5.5V 14.2~16.5V	22.8~26.4V 4.75~5.5V	22.8~26.4V 11.4~13.2V	11.4~13.2V 11.4~13.2V	14.2~16.5V 14.2~16.5V

# Common Features for MP&NMP

## Modular Power Design

Easy configurable design, offer the most flexible power solutions.



## Programmable Output Function

Output voltage is adjustable. By using external DC signal, output voltage can be tuned up or down according to end user's need.

### NMP Series



PV range: 50%-100%  
PC range: 40%-100%

### MP Series



PV range:  $\pm 5\%$

## Multiple Application

MP and NMP series cover wide output voltage range. MP series covers 1.6~53 Vdc, and NMP series covers 3~55 Vdc. Furthermore, with parallel and series connection function, both series can easily meet various power requirements.

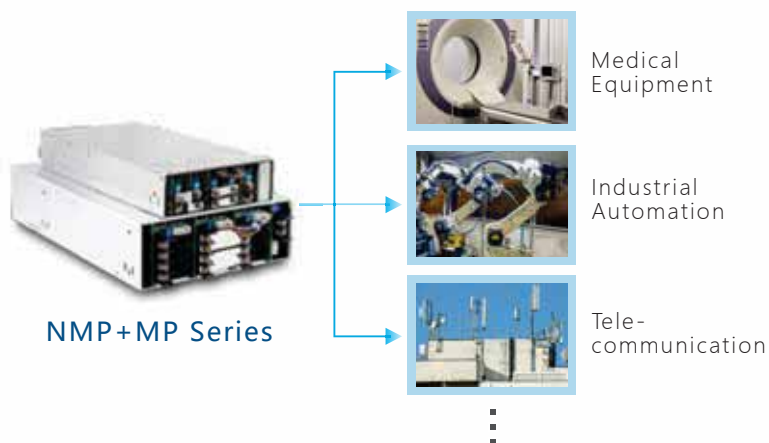

## Compact Dimension

### NMP Series

Dimensions(LxWxH):

- NMP650: 250x 89x 41mm
- NMP1K2: 250x 127x 41mm



### MP Series

Dimensions(LxWxH):

- MP450: 254x 127x 63.5mm
- MP650: 278x 127x 63.5mm
- MP1K0: 278x 177.8x 63.5mm





# New for NMP Series

## Intelligent Control

NMP Series features remote ON/OFF, DC OK signal output, T-alarm signal output, and PC & PV output programmable functions to enable system with smart monitoring and handy control over power supply.

### Remote ON/OFF

With Global and Local ON/OFF control, it allows user to turn on all modules at once or turn on specific module.

### T-alarm

By adopting this new feature, PSU can send out over-temperature alert thru TTL signal to system warning possible over-heating event.

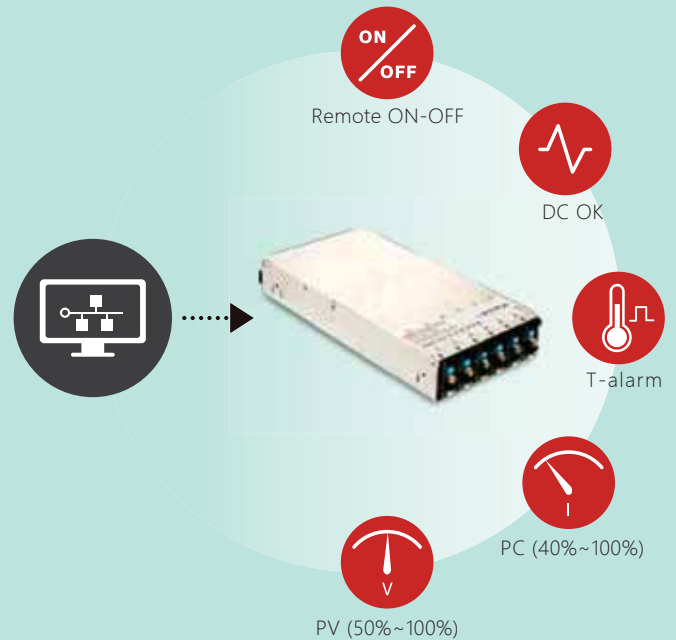

## Easy Inventory Management

NMP Series has a lean product line-up with merely 2 front-ends and 4 power modules in total. Inventory management is no longer a difficult job for distributors!

NMS-240



MS-75/150/  
210/300/  
360



MD-100

## 1U Low Profile

MEAN WELL design engineers implement the latest technology to make possible NMP Series in a slim size. NMP Series successfully reduces nearly 60% in size compared with its predecessor MP Series. Thanks to its smaller size, NMP Series can be used on applications that space constraint is a critical concern to system design.

60%



# Assembly Illustration for NMP Series

## Product Description

Configurable type power supply, NMP family, is a 1U low profile modular power. This family comprises two models, NMP650 (650W) and NMP1K2 (1200W). To offer wide application aspects, NMP family complies with medical standards safety approval and its design refers to ITE standards. Furthermore, by applying safety approvals on Front-End (NMP650 & NMP1K2) and power modules (NMS-240) respectively, distributors whose technical and service capability being qualified by MEAN WELL might be officially authorized to assemble NMP power systems according to end customers' requirements.

Remove screws from left and right sides of the case. And detach the top cover.



STEP 1

Install modules to NMP1K2/NMP650 Front-End in the order from right to left. 5V / 12V / 24V / 48V modules are available for choice.

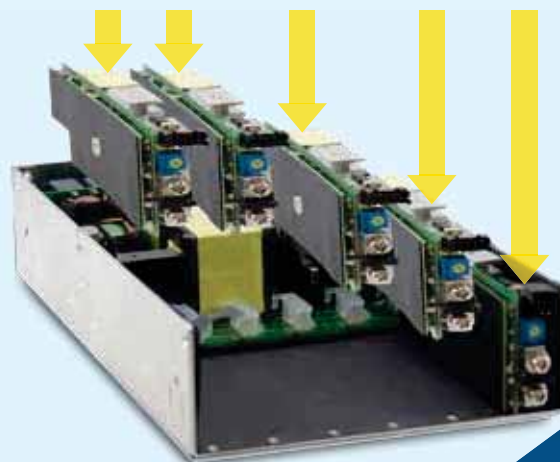

STEP 2

Put back the top cover and fasten screws to positions as illustration.



STEP 3

Stick corresponding product model label onto top cover of Front-End.



STEP 4

Apply AC power to NMP1K2 / NMP650 and measure output voltage to ensure each module functions properly. Use two 2-unit parallel cooper plates, FAP-009, to connect +V and -V terminals of slot 1 and slot 2, and use accessory cable to parallel GND pins and signals when modules in parallel.



STEP 5

Welcome to scan QR codes for more product information.



Introduction Video

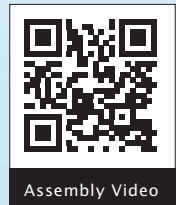

Assembly Video



**Taiwan** (Headquarters)

**MEAN WELL ENTERPRISES CO., LTD.**

No. 28, Wuquan 3rd Road, Wugu District,  
New Taipei City, Taiwan, 24891

**Tel** +886-2-2299-6100(rep.)

**Fax** +886-2-2299-6200(rep.) +886-2-2298-0818(sales)

**e-mail** info@meanwell.com

**Web** www.meanwell.com

**U.S.A.**

**MEAN WELL USA, INC.**

44030 Fremont Blvd., Fremont, CA 94538, U.S.A.

**Tel** +1-510-683-8886

**Fax** +1-510-683-8899

**e-mail** info@meanwellusa.com **Web** www.meanwellusa.com

**Europe**

**MEAN WELL EUROPE B.V.**

Langs de Werf 8, 1185XT Amstelveen, the Netherlands

**Tel** +31-20-758-6000

**Fax** +31-20-758-6001

**e-mail** info@meanwell.eu **Web** www.meanwell.eu



**info@meanwell.com**  
**www.meanwell.com**



**China**

**MEAN WELL (GUANGZHOU) ELECTRONICS CO., LTD.**

No.11, Jingu South Road, Huadong Town, Huadu District,  
Guangzhou, Guangdong, China

**Tel** +86-20-3773-7100 / 400-800-3608(sales)

+86-10-5200-1817(Beijing Office)

+86-755-2359-1630(Shenzhen Office)

**R&D Center**

2F, A Building, Yuean Industry Park, Huangcun,  
Dongpu Town, Tianhe District, Guangzhou, China

Post Code: 510660

**Tel** +86-20-2887-1200(rep.)

**Fax** +86-20-8201-0507

**e-mail** info@meanwell.com.cn **Web** www.meanwell.com.cn

**SUZHOU MEAN WELL TECHNOLOGY CO., LTD.**

No.77, Jian-Ming Rd. Dong-Qiao, Pan-Yang Ind. Park, Huang-Dai  
Town, Xiang-Cheng District, Suzhou, Jiang-Su, China

**Tel** +86-512-6508-8600

**Fax** +86-512-6508-8700

**e-mail** info@meanwell.cc

**Web** www.meanwell.cc

