

客户料号:R694
产品图号:

版次	详细描述	变更日期	变更者
A/0			

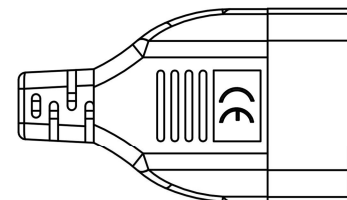

2030 ± 35

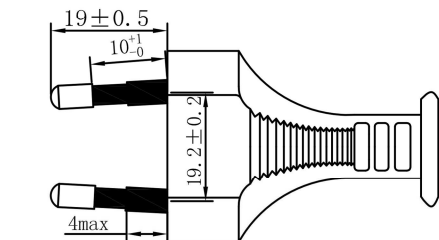
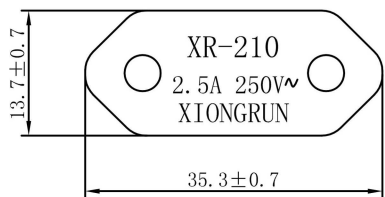
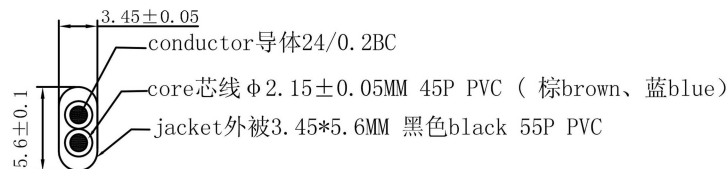
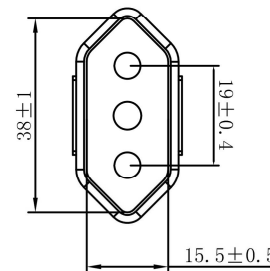
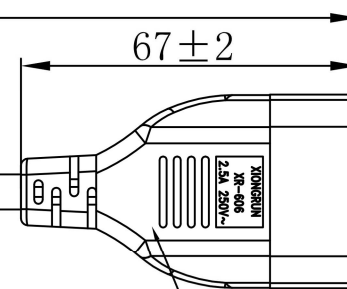
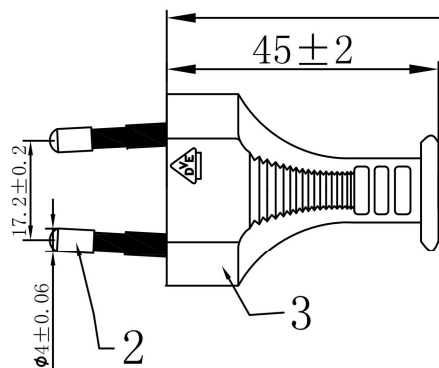

线材印字为凹印, 字轮编号: BY103 wire marking:
◁VDE▷ KEMA-KEUR H03VVH2-F 2X0.75mm² Q080451 GUANGDONG
XIONGRUN ELECTROCAL CO., LTD.

技术要求: requirement:

- 1: 耐压测试: 外高压4200V/S; 内高压2500V/S 0.5-1.0mA
Dielectric voltage: between jacket and conductors 4200V/S
between conductors 1500V/S
- 2: 绝缘阻抗不小于100兆欧.
Insulation resistance 100MΩ.
- 3: 100%导通OK.
Continuity of lead 100% OK.
- 4: 符合ROHS
RoHS COMPLIANT

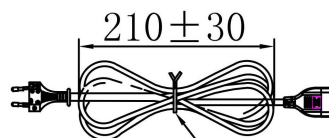

黑色扎带

6	欧规两芯母内架, 黑色	JB6063001-0	1	EA
5	两芯母欧洲端子	DAAZ00003T-1B	2	EA
4	欧洲母插头 (XR-606) COLOR: 黑色black 55P PVC	BC7055PBK0011	0.015	KG
3	欧洲插头 (XR-210) COLOR: 黑色black 55P PVC	BC7055PBK0011	0.0172	Kg
2	两芯欧洲端子(黑色绝缘)	DAAZ00001T-1B	1	EA
1	H03VVH2-F 2X0.75mm ² COLOR: 黑色black 裁线长:L=2000mm.	CV3H22075A00101	1	EA
NO.	DESCRIPTION	Xiongrun PN	QTY	unit

HAWA
Hans Wagner GmbH

DESCRIPTION	AC POWER CABLE	DRAW NO.	XR-0672327	UNIT	M M
PARTS NO		SCALE	NONE	DATE	05/10/2015
APPROVED		CHECKED		DRAWING	