

Order No. :DC PLUG-P1J-R1B

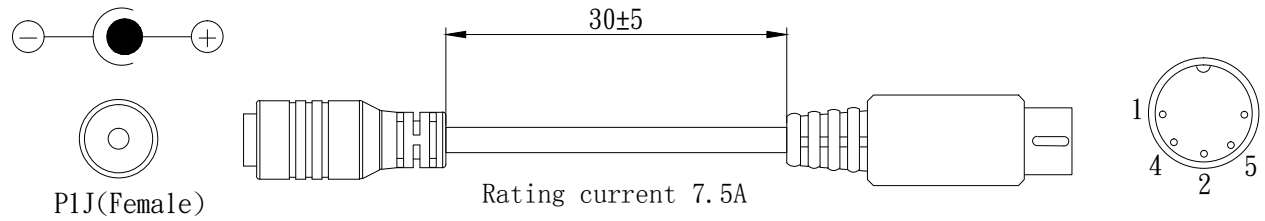

Pin Assignmet

P1J+ connected to R1B P3、5 (+)

P1J- connected to R1B P1、2、4 (-)

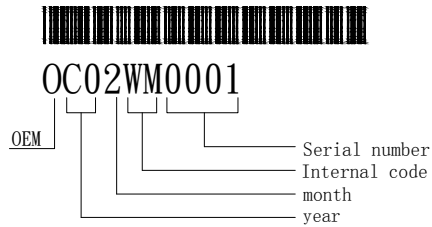

O:OEM

C0:2020 (A:0, B:1, C:2)

2:February(A:10, B:11, C:12)

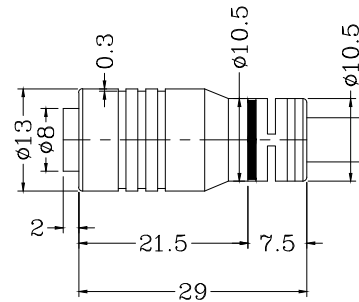

WM:Internal code

0001:Serial number

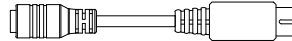

Remark:

1. 30pcs per packing

PACKAGING BAG	
MW' s Order NO.	DC PLUG-P1J-R1B
Specification	Straight P1J(2.1*5.5*11mm) → 5pin din R1B  R1B P3、5 (+)  R1B P1、2、4 (-)
Quantity	1 pc
Bar code	 OC02WM0001

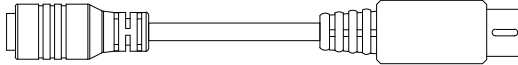

明緯企業股份有限公司

MEAN WELL ENTERPRISES CO., LTD.

DC PLUG

P/NO: PFF1DC PLUG-P1J-R1B

Made by TA WANG

Date: 2022-07-13