

Cuerpo
Body

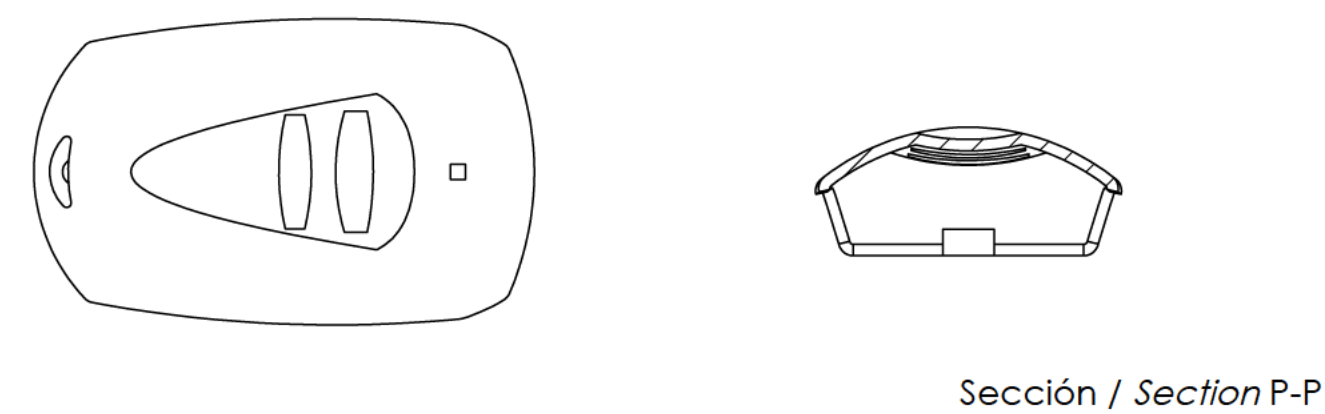

Sección / Section P-P

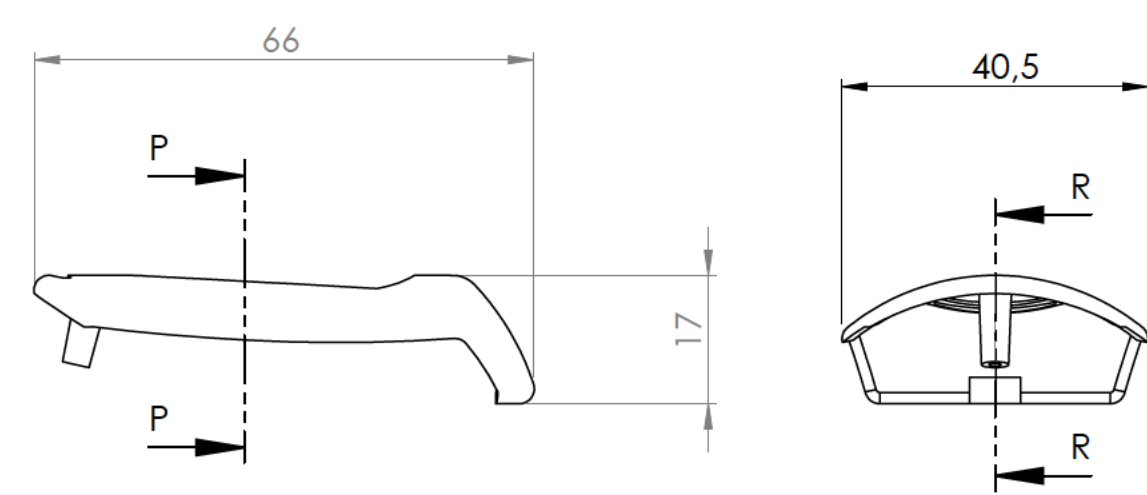
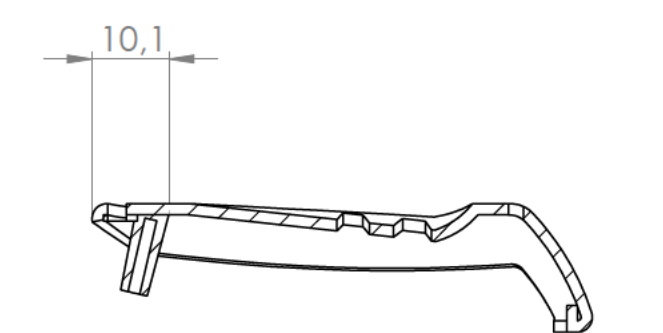

Sección / Section R-R

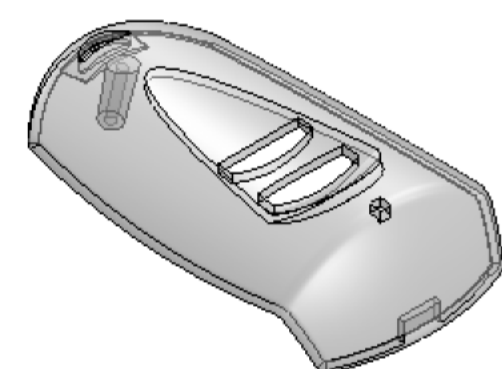

Tapa
Cover

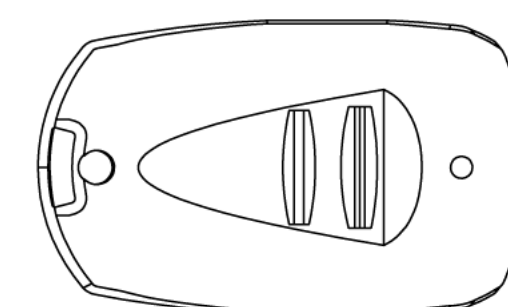
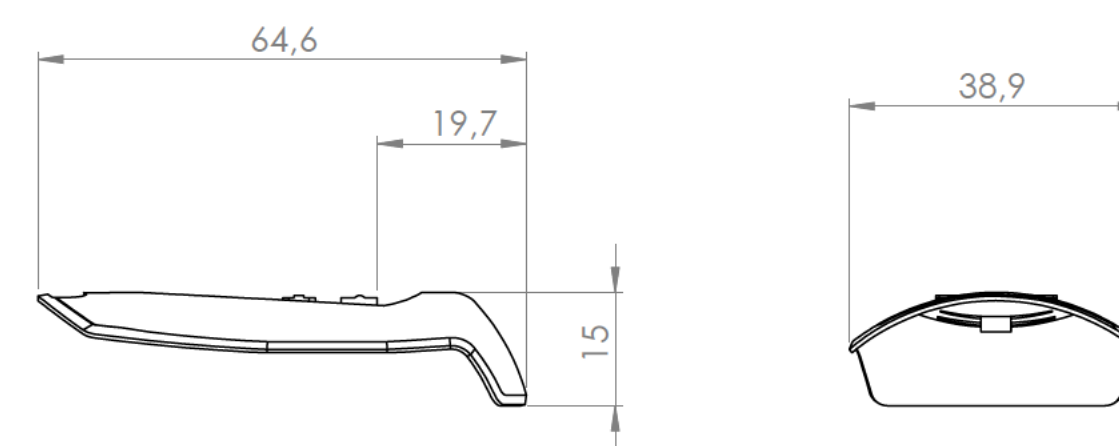
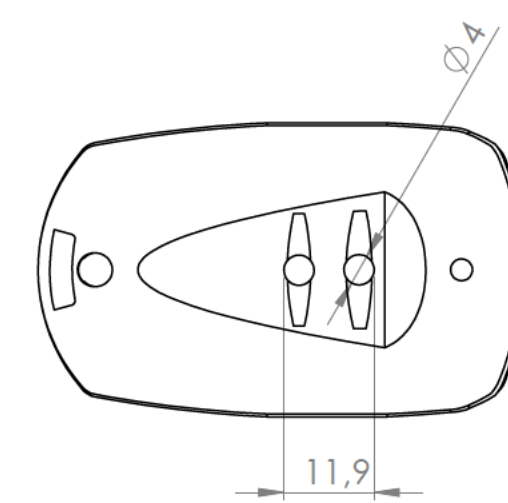

Junta
Joint

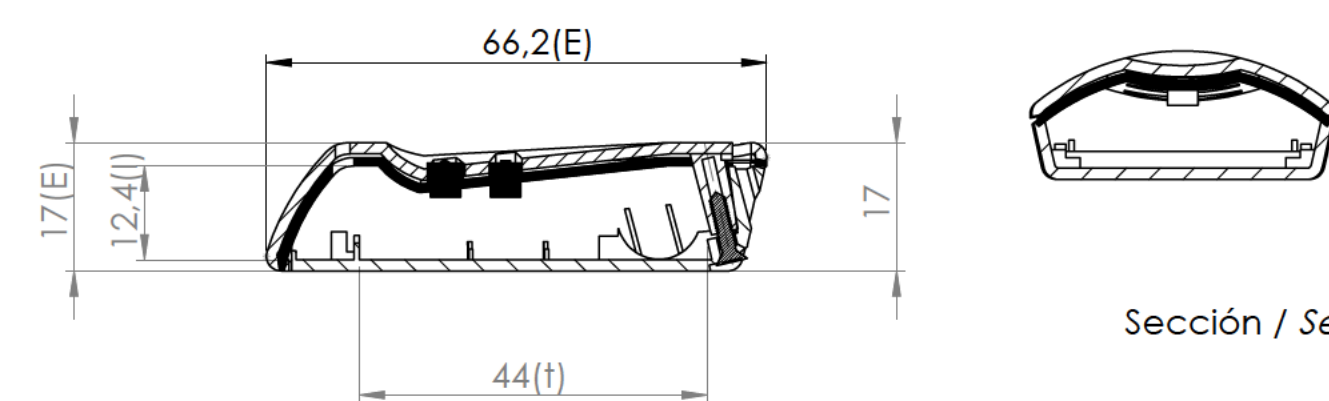
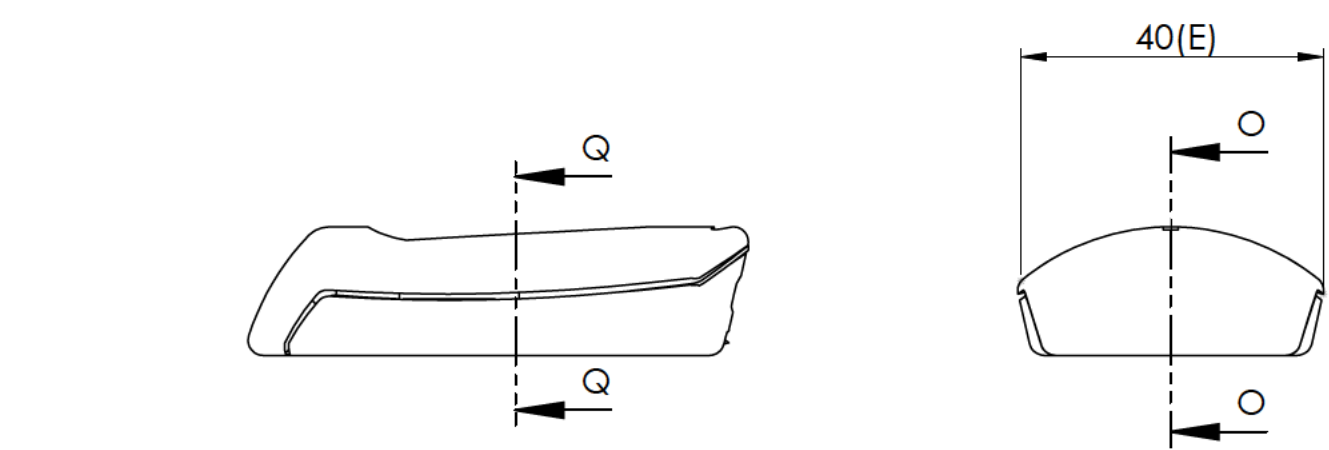

Sección / Section O-O

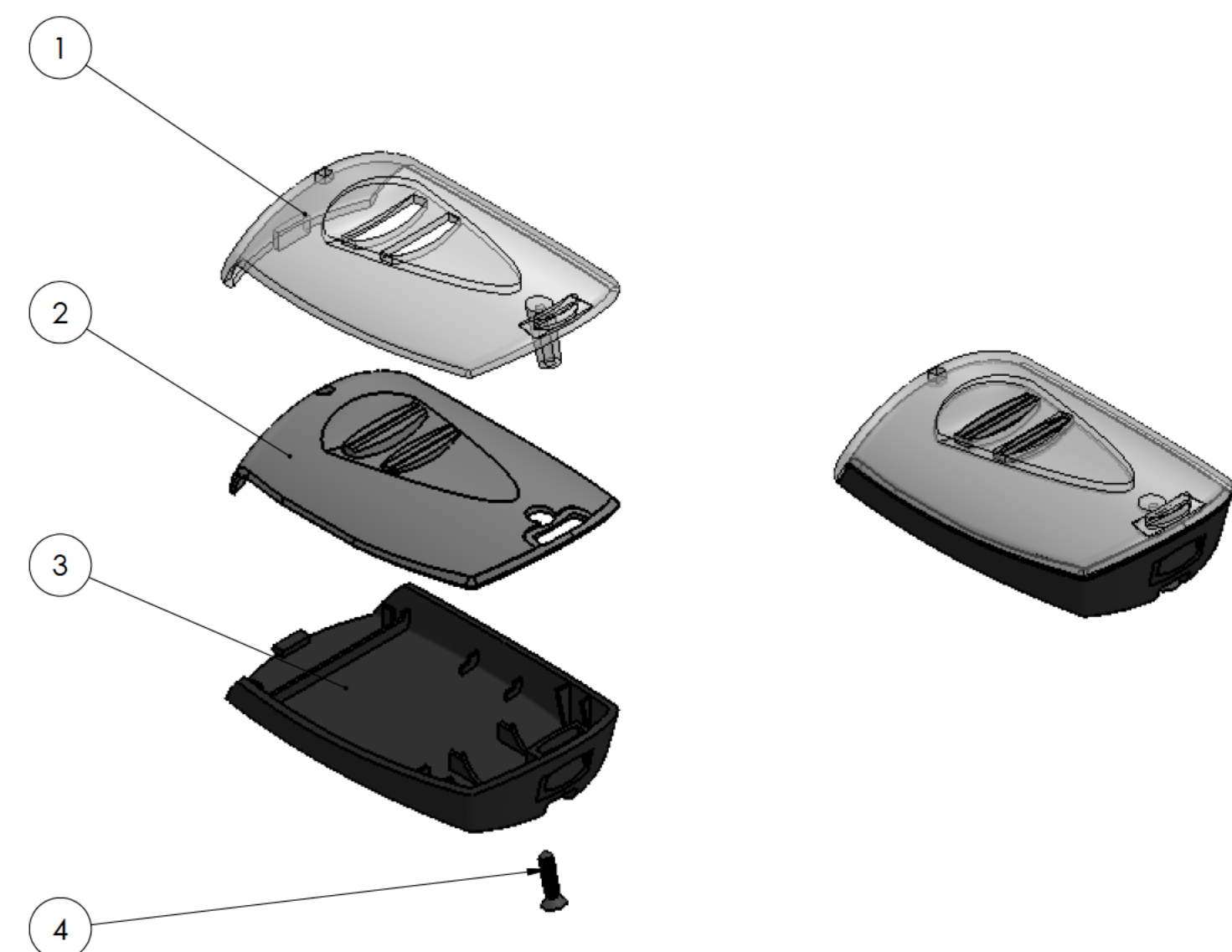
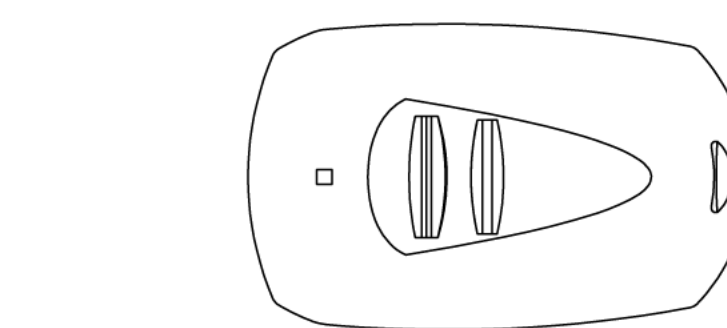

Conjunto
Assembly

Posición / Position	Descripción / Description	Referencia / Reference	Peso / Weight	Unidades / Units	Peso / Weight	Dimensiones exteriores / External dimensions	Material / Material	Acabado / Finish	Al copiar esta información no se actualizará. / Copy for information will not be updated	
1	Cuerpo / Body			1	11,4gr	66,2x42x17	ABS	Mate / Mat	Modelo / Model	PP114
2	Tapa / Cover			1						
3	Junta / Joint			1						
4	Tornillo 2,2x9,5 / Screw 2,2x9,5	DIN 7982		1						
5										
6										
7										
8										
9										
10										

Nombre / Name	Fecha / Date	Todas las cotas son en mm. / All dimensions are in mm.
Joaquín M.	6-9-2018	A1

www.supertronic.com	supertronic@supertronic.com	+34 932 980 257
---------------------	-----------------------------	-----------------

Este documento contiene información propiedad de SUPERTRONIC, S.A. y es ofrecida en condiciones de uso informativo con la confianza que no será reproducida ni copiada y no será utilizada o incorporada en cualquier producto de otra empresa sin el consentimiento escrito de SUPERTRONIC, S.A. and is intended subject to the conditions that the information be retained in confidence not be reproduced or copied and not be used or incorporated in any product.