



# **RCP-1000 / RCP-1U Instruction Manual**

<b>0. Safety Guidelines</b> .....	1
<b>1. Introduction of Series Models</b> .....	1
1.1 Introduction .....	1
1.2 Features .....	1
1.3 Order Information .....	1
1.4 Main Specification .....	2
<b>2. Mechanical Specification and Input / Output Terminals</b> .....	3
2.1 Mechanism of Single Unit .....	3
2.2 Mechanism of Whole Rack System .....	4
<b>3. Functions</b> .....	5
3.1 Input Voltage Range .....	5
3.2 Inrush Current Limiting .....	5
3.3 Output Power .....	5
3.4 Power Factor Correction (PFC) .....	5
3.5 Output Voltage Adjustment .....	5
3.6 Fan Speed Control .....	7
3.7 Short Circuit Protection & Over Current Protection .....	7
3.8 Over Voltage Protection (O.V.P.) .....	7
3.9 Over Temperature Protection (O.T.P.) .....	7
3.10 Over Temperature Alarm .....	7
3.11 AC OK Signal .....	7
3.12 DC OK Signal .....	7
3.13 Fan Malfunction Protection .....	7
3.14 Remote Control .....	7
3.15 Remote Sense .....	7
3.16 Hot-Swap Operation .....	8
3.17 Parallel Operation .....	8
3.18 Series Operation .....	9
3.19 Auxiliary Output .....	9
3.20 Operation of I <sup>2</sup> C Data Bus (RCP-1000-C models only) .....	9
<b>4. Notes on Operation</b> .....	12
4.1 Installation Method .....	12
4.2 Derating .....	13
4.3 Warranty .....	13

## 0. Safety Guidelines

- ⊙ Risk of electrical shock and energy hazard. All kinds of failure should be examined by the qualified technician. Please do not remove the case of the RCP-1000 or RCP-1U by yourself!
- ⊙ Please do not change any component on the RCP series by yourself or make any kind of modification on it.
- ⊙ Please do not install the RCP series in places with high moisture or near the water.
- ⊙ Please do not install the RCP series in places with high ambient temperature or under direct contact of sunlight.
- ⊙ The rated input voltage / frequency are 100~240VAC and 50/60 Hz. Please don't feed in AC power that over  $\pm 10\%$  of the rated value.
- ⊙ Safety protection level of this unit is class I. The grounding wire should be firmly fixed at the "FG" terminal ( $\neq$ ) of the rack. The total leakage current of the rack system (including 3 \* RCP-1000 units and 1 RCP-1U rack) is less than 3.5mA.

## 1. Introduction of Series Models

### 1.1 Introduction

RCP series are rack-mounted power supplies that provide power source for telecom equipments, servers, or monitoring equipments in the 19" racks.

### 1.2 Features

- ⊙ 44 mm low profile, suitable for standard 1U rack applications.
- ⊙ Universal AC input / Full range.
- ⊙ Built-in active PFC function, PF>0.96.
- ⊙ Protections: short circuit / overload / over voltage / over temperature.
- ⊙ Active current sharing up to 3000W (3 units) in one 19" rack ; up to 3 racks (8units maximum) can be connected in parallel.
- ⊙ Remote control for single RCP-1000 unit.
- ⊙ Built-in remote sense function.
- ⊙ Output voltage can be trimmed between 90~110% rated output voltage.
- ⊙ Hot-swap operation.
- ⊙ AC OK and DC OK signal output.
- ⊙ Forced air cooling by built-in DC fan with fan speed control function.
- ⊙ 5V / 0.3A auxiliary output.
- ⊙ Built-in ORing diode.
- ⊙ I<sup>2</sup>C serial data bus (RCP-1000-C models only).
- ⊙ 3 years warranty.

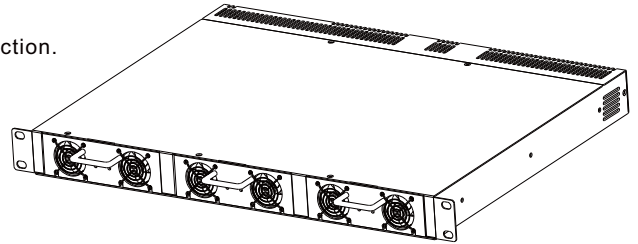

### 1.3 Order Information

#### 1.3.1 Explanation for Encoding

Single unit : RCP-1000-**12**-**C**

C : with I<sup>2</sup>C data bus  
— : without I<sup>2</sup>C data bus  
output voltage

1U rack : RCP-1U **I**

I : IEC320-C14 AC inlet  
T : terminal block

Whole system (3 \* RCP-1000 + RCP-1U<sub>T</sub>) :

RCP-3K1U **I** - **12** - **C**

C : with I<sup>2</sup>C data bus  
— : without I<sup>2</sup>C data bus  
output voltage  
I : IEC320-C14 AC inlet  
T : terminal block

#### 1.3.2 Marking

- ⊙ Please refer to the safety label on top of each unit before operating (Figure 1-1~1-3).
- ⊙ Single unit (RCP-1000):



Figure 1-1: Safety labels of RCP-1000

◎Rack (RCP-1U□) :

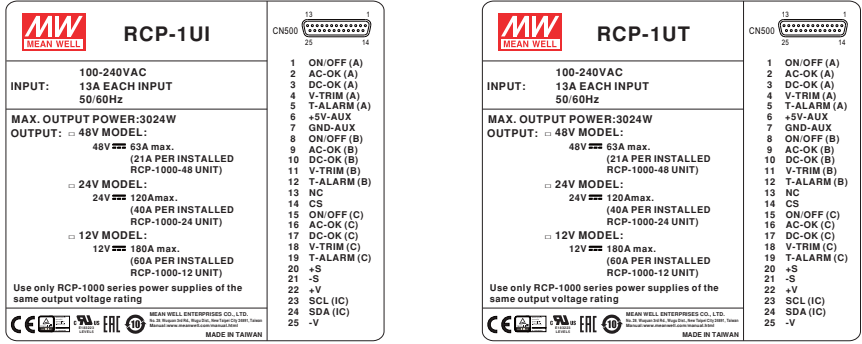

Figure 1-2: Safety labels of RCP-1U□

◎Whole system (3 \* RCP-1000 + RCP-1U□) :

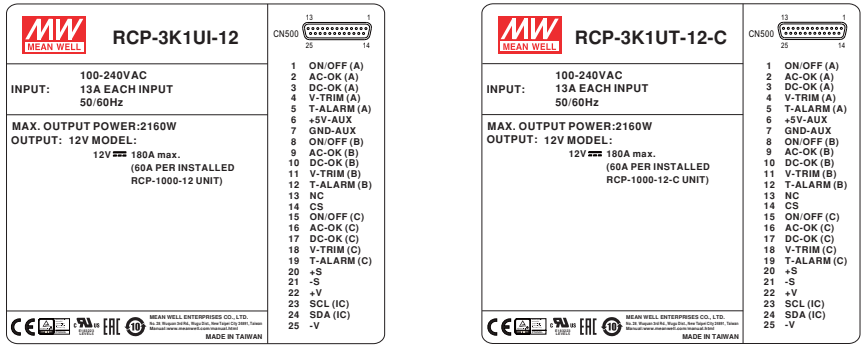

Figure 1-3: Safety labels of the whole RCP system

1.4 Main Specification

◎Single unit

MODEL	RCP-1000-12	RCP-1000-24	RCP-1000-48				
OUTPUT	DC VOLTAGE	12V	24V	48V			
	RATED CURRENT	60A	40A	21A			
	CURRENT RANGE	0 ~ 60A	0 ~ 40A	0 ~ 21A			
	RATED POWER	720W	960W	1008W			
	RIPPLE & NOISE (max.) Note.2	150mVp-p	200mVp-p	300mVp-p			
	VOLTAGE ADJ. RANGE (SVR)	11.6 ~ 12.4V	23.2 ~ 24.8V	46.3 ~ 49.7V			
	VOLTAGE TOLERANCE Note.3	±1.0%	±1.0%	±1.0%			
	LINE REGULATION	±0.5%	±0.5%	±0.5%			
	LOAD REGULATION	±0.5%	±0.5%	±0.5%			
	SETUP, RISE TIME	1000ms, 60ms/230VAC at full load					
HOLD UP TIME (Typ.)	16ms/230VAC at full load						
INPUT	VOLTAGE RANGE Note.4	90 ~ 264VAC	127 ~ 370VDC				
	FREQUENCY RANGE	47 ~ 63Hz					
	EFFICIENCY (Typ.)	81%	87%	89%			
	AC CURRENT (Typ.)	8.5A/115VAC	4.5A/230VAC	10.5A/115VAC	5.5A/230VAC	11A/115VAC	5.5A/230VAC
	INRUSH CURRENT (Typ.)	COLD START 50A					
LEAKAGE CURRENT	<1.1mA / 230VAC						
PROTECTION	OVERLOAD	105 ~ 125% rated output power Protection type : Constant current limiting, recovers automatically after fault condition is removed					
	OVER VOLTAGE	13.2 ~ 16.2V	26.4 ~ 32.4V	52.8 ~ 64.8V			
	OVER TEMPERATURE	Shut down o/p voltage, recovers automatically after temperature goes down					

MODEL		RCP-3K1U□-12	RCP-3K1U□-24	RCP-3K1U□-48	
OUTPUT	RECTIFIER	RCP-1000-12	RCP-1000-24	RCP-1000-48	
	RACK SHELF	RCP-1UI or RCP-1UT			
	OUTPUT VOLTAGE	12V	24V	48V	
	MAX. OUTPUT CURRENT	180A	120A	63A	
	MAX. OUTPUT POWER <small>Note.5</small>	2160W	2880W	3024W	
INPUT	VOLTAGE RANGE <small>Note.4</small>	90 ~ 264VAC 127 ~ 370VDC			
	FREQUENCY RANGE	47 ~ 63Hz			
	AC CURRENT (Typ.)/PER MODULE	8.5A/115VAC 4.5A/230VAC	10.5A/115VAC 5.5A/230VAC	11A/115VAC 5.5A/230VAC	
	LEAKAGE CURRENT	<3.5mA / 230VAC			
FUNCTION	AUXILIARY POWER	5V @ 0.3A			
	REMOTE ON-OFF CONTROL	By electrical signal or dry contact ON:short OFF:open			
	REMOTE SENSE	Compensate voltage drop on the load wiring up to 0.5V.			
	OUTPUT VOLTAGE PROGRAMMABLE	Adjustment of output voltage is allowable to 90 ~ 110% of nominal output voltage. Please refer to the Function Manual.			
	DC OK SIGNAL	The isolated TTL signal out, Please refer to the Installation Manual			
	AC OK SIGNAL	The isolated TTL signal out, Please refer to the Installation Manual			
	OVER TEMP WARNING	Logic " High" for over temperature warning, Please refer to the Installation Manual, isolated signal			
ENVIRONMENT	WORKING TEMP.	-20 ~ +60°C (Refer to "Derating Curve")			
	WORKING HUMIDITY	20 ~ 90% RH non-condensing			
	STORAGE TEMP., HUMIDITY	-40 ~ +85°C, 10 ~ 95% RH non-condensing			
	TEMP. COEFFICIENT	±0.02%/°C (0 ~ 50°C)			
	VIBRATION	10 ~ 500Hz, 2G 10min./1cycle, 60min. each along X, Y, Z axes			
SAFETY & EMC (Note 6)	SAFETY STANDARDS	UL60950-1, TUV EN60950-1, EAC TP TC 004 approved			
	WITHSTAND VOLTAGE	I/P-O/P:3KVAC I/P-FG:2KVAC O/P-FG:0.7KVDC			
	ISOLATION RESISTANCE	I/P-O/P, I/P-FG, O/P-FG:100M Ohms / 500VDC / 25°C / 70% RH			
	EMC EMISSION	Parameter	Standard	Test Level / Note	
		Conducted	EN55032 (CISPR32) / EN55011 (CISPR11)	Class B	
		Radiated	EN55032 (CISPR32) / EN55011 (CISPR11)	Class B	
		Harmonic Current	EN61000-3-2	-----	
		Voltage Flicker	EN61000-3-3	-----	
	EMC IMMUNITY	EN55024, EN61204-3, EN61000-6-2			
		Parameter	Standard	Test Level / Note	
ESD		EN61000-4-2	Level 3, 8KV air ; Level 2, 4KV contact		
Radiated		EN61000-4-3	Level 3		
EFT / Burst		EN61000-4-4	Level 3		
Surge		EN61000-4-5	Level 4, 4KV/Line-Earth ; Level 3, 2KV/Line-Line		
Conducted		EN61000-4-6	Level 3		
Magnetic Field		EN61000-4-8	Level 4		
Voltage Dips and Interruptions	EN61000-4-11	>95% dip 0.5 periods, 30% dip 25 periods, >95% interruptions 250 periods			
OTHERS	DIMENSION	Rack 483.6*350.8*44(L*W*H)			
	PACKING	13.2Kg; 1pcs/13.2Kg/2.67CUFT			
NOTE	<p>1. All parameters NOT specially mentioned are measured at 230VAC input, rated load and 25°C of ambient temperature.</p> <p>2. Ripple &amp; noise are measured at 20MHz of bandwidth by using a 12" twisted pair-wire terminated with a 0.1uf &amp; 47uf parallel capacitor. Under parallel operation of more than one rack connecting together, ripple of the output voltage may be higher than the SPEC at light load condition. It will go back to normal ripple level once the output load is more than 10%. .</p> <p>3. Tolerance : includes set up tolerance, line regulation and load regulation.</p> <p>4. Derating may be needed under low input voltages. Please check the derating curve for more details.</p> <p>5. Output of all the RCP-1000 modules are connected in parallel in the rack.</p> <p>6. The power supply is considered a component which will be installed into a final equipment. All the EMC tests are been executed by mounting the unit on a 720mm*360mm metal plate with 1mm of thickness. The final equipment must be re-confirmed that it still meets EMC directives. For guidance on how to perform these EMC tests, please refer to "EMI testing of component power supplies." (as available on <a href="http://www.meanwell.com">http://www.meanwell.com</a>)</p> <p>7. The ambient temperature derating of 3.5°C/1000m with fanless models and of 5°C/1000m with fan models for operating altitude higher than 2000m(6500ft).</p>				

## 2. Mechanical Specification and Input / Output Terminals

### 2.1 Mechanism of Single Unit

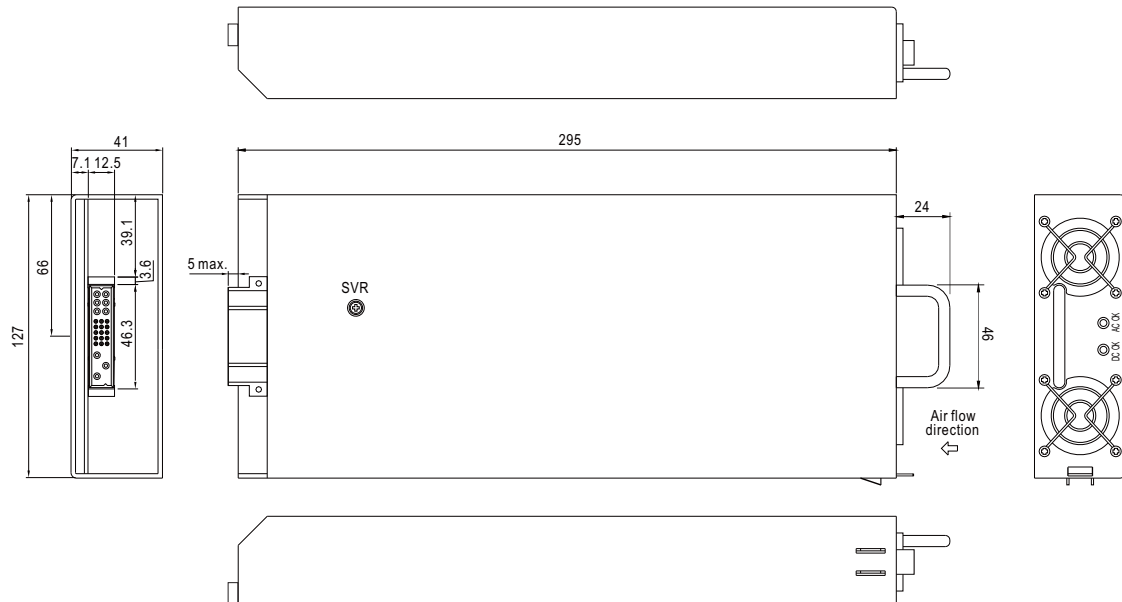

Input / Output Connector Pin. No Assignment(CN501) : Postronic PCB24W9M400A1

Pin No.	Assignment	Pin No.	Assignment	Pin No.	Assignment	Pin No.	Assignment	Mating Housing
1,2,4	+V	10	AC_OK	15	+5V_AUX	20	A1	Postronic PCIB24W9F400A1
3,5,6	-V	11	DC_OK	16	GND_AUX	21	A2	
7	ON/OFF	12	CS	17	SDA	22	FG	
8	+S	13	V_TRIM	18	SCL	23	AC/L	
9	-S	14	T_ALARM	19	A0	24	AC/N	

## 2.2 Mechanism of Whole Rack System

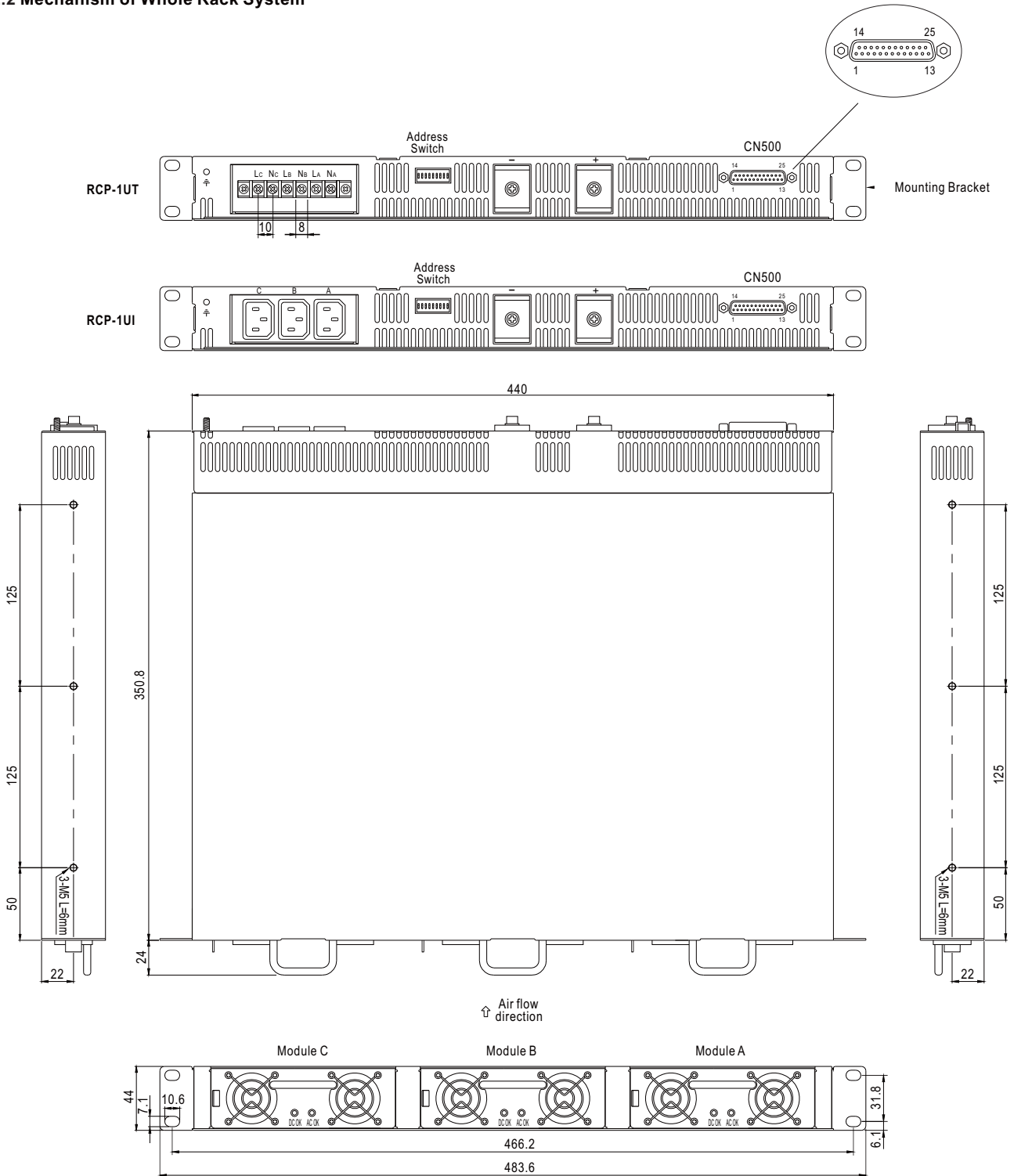

Connector Pin No. Assignment(CN500) : D-Type Right Angle 25 positions

Pin No.	Assignment	Pin No.	Assignment	Pin No.	Assignment	Pin No.	Assignment	Pin No.	Assignment
1	ON/OFF-A	6	+5V-AUX	11	V-TRIM-B	16	AC-OK-C	21	-S
2	AC-OK-A	7	GND-AUX	12	T-ALARM-B	17	DC-OK-C	22	+V
3	DC-OK-A	8	ON/OFF-B	13	NC	18	V-TRIM-C	23	SCL
4	V-TRIM-A	9	AC-OK-B	14	CS	19	T-ALARM-C	24	SDA
5	T-ALARM-A	10	DC-OK-B	15	ON/OFF-C	20	+S	25	-V

◎Description of CN500 in/out connection pins

Pin No.	Function	Description
1,8,15	ON/OFF	Each unit can separately turn the output on and off by electrical or dry contact between ON/OFF A,B,C(pin 1,8,15) and -S(pin 21). Short: ON, Open:OFF.
2,9,16	AC-OK	High : When the input voltage is $\geq 82V_{rms} \pm 4V$ . Low : when the input voltage in $\leq 82V_{rms} \pm 4V$ .
3,10,17	DC-OK	High : When the $V_{out} \geq 80\% \pm 5\%$ . Low : When $V_{out} \leq 80\% \pm 5\%$
4,11,18	V-TRIM	Connection for output voltage trimming. The voltage can be trimmed within its defined range.
5,12,19	T-ALARM	High : When the internal temperature is within safe limit. Low : $10^{\circ}C$ below the thermal shut down limit.
6	+5V-AUX	Auxiliary voltage output, 4.3~5.3V, referenced to GND-AUX(pin 7). The maximum load current is 0.3A. This output has the built-in "Oring diodes" and is not controlled by the remote ON/OFF control.
7	GND-AUX	Auxiliary voltage output GND. The signal return is isolated from the output terminals (+V & -V).
14	CS	Current sharing signal. When units are connected in parallel, the CS pins of the units should be connected to allow current balance between units.
20	+S	Positive sensing. The +S signal should be connected to the positive terminal of the load. The +S and -S leads should be twisted in pair to minimize noise pick-up effect. The maximum line drop compensation is 0.5V.
21	-S	Negative sensing. The -S signal should be connected to the negative terminal of the load. The -S and +S leads should be twisted in pair to minimize noise pick-up effect. The maximum line drop compensation is 0.5V.
22	+V	Positive output voltage. For local sense use only, can't be connected directly to the load.
23	SCL	Serial clock used on RCP-1000-C models. Refer to the I <sup>2</sup> C interface description.
24	SDA	Serial data used on the RCP-1000-C models. Refer to the I <sup>2</sup> C interface description.
25	-V	Negative output voltage. For local sense use only, can't be connected directly to the load.

### 3.Functions

#### 3.1 Input Voltage Range

- ◎Nominal input voltage range is AC 90~264V or DC 127~370V.
- ◎To insure proper operation, AC input should be within the pre-specified range. The wrong input will cause the power supply to operate improperly, lose the PFC function or even be damaged.
- ◎Since the RCP Series have built-in active PFC circuit, there will be lower efficiency and output derating is required when operating at lower input voltage (<100VAC).

#### 3.2 Inrush Current Limiting

- ◎Built-in inrush current limiting circuit.
- ◎The external switch, if needed, should have a current rating exceeding the maximum inrush current.
- ◎Since the inrush current limiting circuit mainly consists of thermistor and relay, after turning off the power supply, a 10 second cool down period is recommended before turning it back on. Inrush current will be much higher than the specified value if input thermistor is not allowed sufficient time to cool down.

#### 3.3 Output Power

- ◎Single Unit
  - RCP-1000-12 : 720W (12V / 60A)
  - RCP-1000-24 : 960W (24V / 40A)
  - RCP-1000-48 : 1008W (48V / 21A)
- ◎Whole System
  - RCP-3K1U□-12 : 2160W (12V / 180A)
  - RCP-3K1U□-24 : 2880W (24V / 120A)
  - RCP-3K1U□-48 : 3024W (48V / 63A)

#### 3.4 Power Factor Correction (PFC)

- ◎Built-in active power factor correction (PFC) function. Under full load output and the input voltage is within the range of 90~230Vac, PF>0.96; if the output is less than full load or the input voltage is higher than 230Vac, the PF value will be a little less than 0.96.

#### 3.5 Output Voltage Adjustment

##### 3.5.1 Adjustment of single unit

Output voltage of one RCP-1000 is adjustable through the potentiometer (SVR51, can be found under the small circular hole on top of the unit). Please use a cross-screwdriver with isolated holder to make the adjustment.

##### 3.5.2 Adjustment of single unit or the whole rack system

- ◎Output voltage difference of each unit in the same rack should be maintained within  $\pm 1\%$ , or the effectiveness of current sharing might be influenced.
- ◎Output voltage can be adjusted between 90%~110% of rated value by adding external resistors (R1 and R2). Please refer to Figure 3-1for details.
- ◎When the output is tuned to a higher voltage, please notice that the load current should be decreased accordingly. The output wattage of each unit should not exceed its rated value under any circumstances.

### 3.5.3 Wiring of output voltage adjustment (use voltage trimming function)

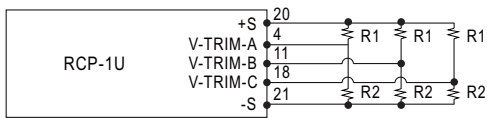
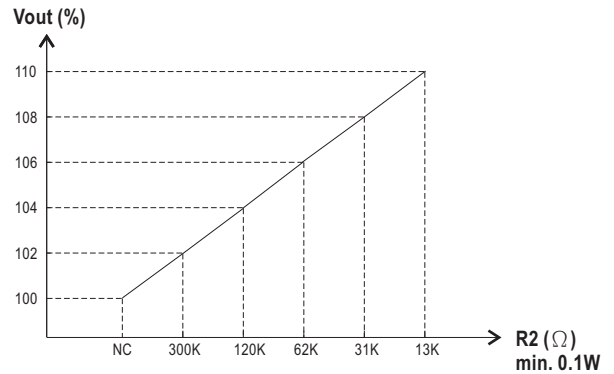
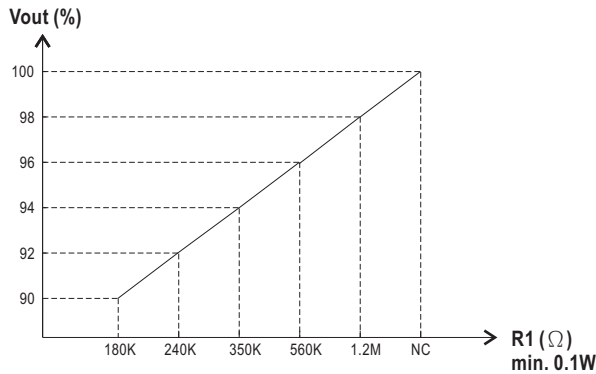

Figure 3-1: Voltage trimming by using external resistors

The resistors R1, R2 mentioned in Figure 3-1 should be added independently and the minimum wattage rating is 0.1W. Please refer to 3.5.4~3.5.6 about the selection of resistance.

### 3.5.4 Reference resistance value of R1/R2 for RCP-1000-12



Note: For adjustment under 100% of rated output voltage, R2 should be opened.  
For adjustment over 100% of rated output voltage, R1 should be opened.

### 3.5.5 Reference resistance value of R1/R2 for RCP-1000-24

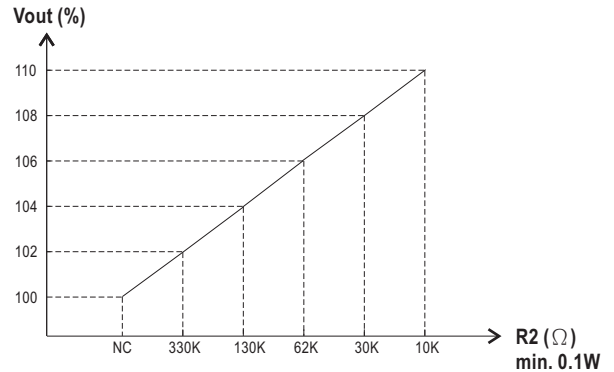
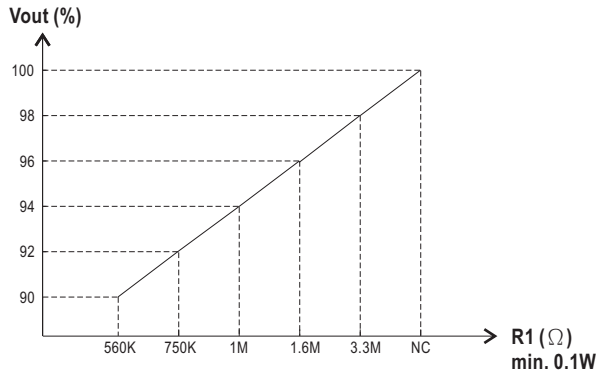

### 3.5.6 Reference resistance value of R1/R2 for RCP-1000-48

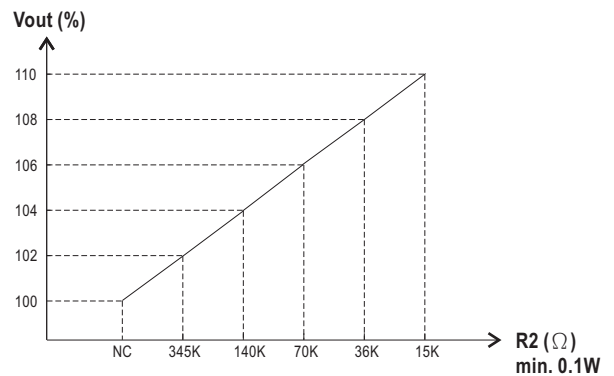
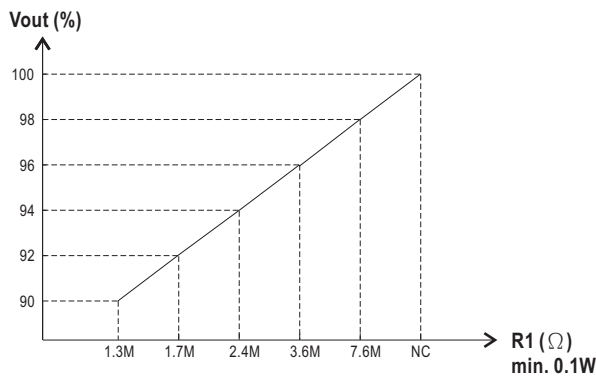



### 3.6 Fan Speed Control

⊙ Built-in fan speed control circuit. The fan speed will be adjusted according to the magnitude of output load.

### 3.7 Short Circuit Protection & Over Current Protection (O.C.P.)

⊙ Protection comes into effect at short circuit condition or  $>115\% \pm 10\%$  of output rated current (constant current limiting mode). The PSU will automatically recover once the short circuit / over current condition is removed.

### 3.8 Over Voltage Protection (O.V.P.)

⊙ Built-in over voltage protection circuit for each RCP-1000 unit.  
 ⊙ The O.V.P. triggering points are different for different output models. Please refer to the specification sheet for details.  
 ⊙ The PSU shuts down when O.V.P. is triggered. To restart the power supply, please switch off AC input first and then wait for 10 seconds before switching it back on.

### 3.9 Over Temperature Protection (O.T.P.)

⊙ Built-in 2 sets of over temperature protection circuit. When the internal temperature exceeds the threshold value, the power supply will shut down automatically (the built-in fan will still operate to cool down the PSU). You should switch off the AC input and remove all possible causes of overheating, and then let the power supply cool down to normal working temperature (needs about 10 minutes~1hour) before turning it back on.  
 ⊙ If the internal temperature is under the threshold value, there will be a "Low" signal (0~0.5V) between "T-ALARM" and "-V" on CN500; if the internal temperature exceeds the threshold value, there will be a "High" signal (4.5~5.5V) between "T-ALARM" and "-V" on CN500 connector.

### 3.10 Over Temperature Alarm

⊙ Every RCP-1000 single unit has a detecting circuit to sense its internal temperature. The value of internal temperature can only be read through the I<sup>2</sup>C interface: when the internal temperature of RCP-1000 is higher than  $60^{\circ}\text{C} \pm 3^{\circ}\text{C}$ , there will be an alarm signal sent out through the I<sup>2</sup>C interface.

### 3.11 AC OK Signal

⊙ Built-in AC input voltage detecting circuit.  
 ⊙ When AC input voltage  $\geq 82\text{V} \pm 4\text{V}$ , the output voltage can start to work properly and the "AC OK" LED on the front panel will light up (see Figure 3-2). In the mean time, there will be a "Low" signal (0~0.5V) between "AC-OK" and "-V" on CN500 connector.  
 ⊙ When AC input voltage  $\leq 82\text{V} \pm 4\text{V}$ , the output voltage will be shut down and the "AC OK" LED on the front panel will be turned off. In the mean time, there will be a "High" signal (4.5~5.5V) between "AC-OK" and "-V" on CN500 connector.

### 3.12 DC OK Signal

⊙ Built-in DC output voltage detecting circuit.  
 ⊙ When DC output voltage  $\geq 80\% \pm 5\%$  of rated value, the "DC OK" LED on the front panel will light up (see Figure 3-2). In the mean time, there will be a "Low" signal (0~0.5V) between "DC-OK" and "-V" on CN500 connector.  
 ⊙ When DC output voltage  $\leq 80\% \pm 5\%$  of rated value, the "DC OK" LED on the front panel will be turned off. In the mean time, there will be a "High" signal (4.5~5.5V) between "DC-OK" and "-V" on CN500 connector.

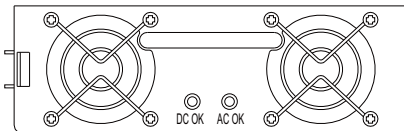

Figure 3-2: Front panel of RCP-1000

### 3.13 Fan Malfunction Protection

⊙ Built-in fan malfunction protection circuit. When the DC fan stop operating (fan lock or wire broken), the output will be shut down. Please switch off the AC source and send back to our local distributor or MEAN WELL for repair.

### 3.14 Remote Control

⊙ Built-in remote ON/OFF control circuit. Please refer to Figure 3-3 for single unit or whole rack control.  
 ⊙ Notice that the "ON/OFF" and "-S" pin on CN500 should be short connected in order to let the PSU operate properly. If it is open, the output voltage will be shut down.

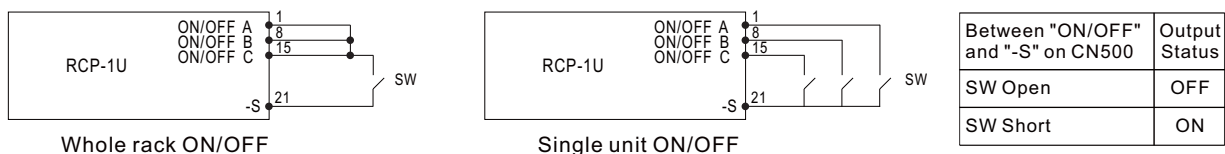

Figure 3-3: Connection for remote ON/OFF control operation

### 3.15 Remote Sense

⊙ Built-in remote sense circuit that can compensate voltage drop up to 0.5V.  
 ⊙ When using this function, the sensing wires should either be twisted or shielded to prevent external noise interference. (refer to Figure 3-4)  
 ⊙ The voltage drop across the output wires must be limited to less than 0.5V. Also heavy wires with adequate current rating should be used between +V/-V and the load. Please firmly connect the output wires to prevent them from losing, or the power supply may be out of order.

- ⊙ **Notice:** It is required to use the "Remote Sense" function to let the PSU work properly. If not, the "Local Sense" is still required that "+S" should be shorted to "+V" and "-S" to "-V" as Figure 3-5. Or the output voltage will be too high which may trigger the over voltage protection.

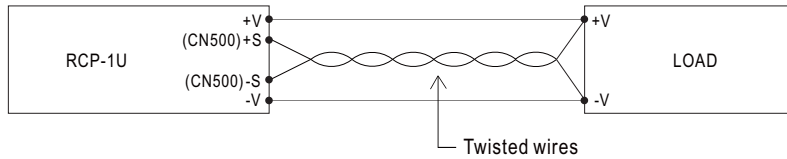

Figure 3-4: Connection for using the "Remote Sense" function

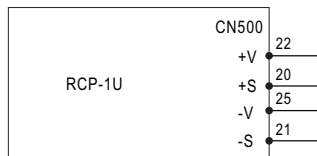

Figure 3-5: Connection for using the "Local Sense" function

### 3.16 Hot-Swap Operation

- ⊙ Built-in "Oring diode" in every RCP-1000 unit that the single unit can be hot-swapped without turning off the AC source provide to the whole rack system.
- ⊙ Insert the RCP-1000 unit: grasp the handle and push inside the rack through the rail.
- ⊙ Pull out the RCP-1000 unit: press the clip shown in Figure 3-6 and pull the unit out.

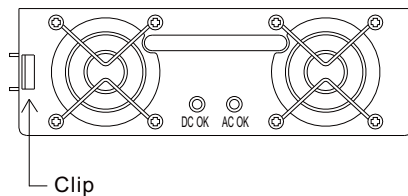

Figure 3-6: Location of the "clip" on RCP-1000 unit

### 3.17 Parallel Operation

#### 3.17.1 Operation of single rack

- ⊙ Internal parallel operation in single rack is only suitable for using the same RCP-1000 unit (single unit with the same output voltage and current).
- ⊙ Each rack (RCP-1U<sub>□</sub>) have the built-in parallel connection / wiring. Once the RCP-1000 unit insert in the rack then the parallel connection is done.
- ⊙ Under parallel operation, the connection of other functions can refer to section 3.14 & 3.15.

#### 3.17.2 Operation of three racks in parallel

- ⊙ Parallel operation is only suitable for the same RCP-1000 unit (single unit with the same output voltage and current) located in up to 3 racks. Totally 8 identical single units operate in parallel is the maximum.
- ⊙ Under parallel operation, the total output current should not exceed 90% of the sum of rated currents.  
For example: RCP-1000-24x8 connected in parallel (in 3 racks), the maximum output current should be  $40A \times 8 \text{ unit} \times 0.9 = 288A$
- ⊙ Adjust the output voltage of all the single units to the value you need and minimize the differences to less than 1% among one another before operating in parallel.
- ⊙ Please paralleling the racks first and then connect to the load (refer to Figure 3.7). Do not connect each rack to the load separately!
- ⊙ The control signals CS, +S, -S should also be connected in parallel. (refer to Figure 3.7)
- ⊙ Twisted wires should be used for the wiring of +S and -S. To avoid the interference, the twisted wires should not touch the load wires. (refer to Figure 3.7)

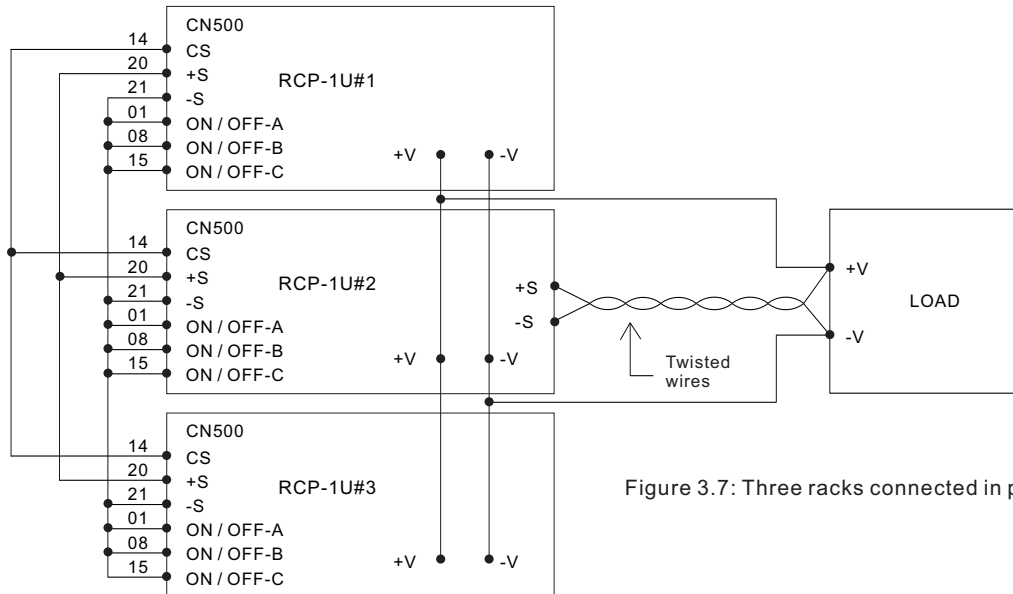

Figure 3.7: Three racks connected in parallel

⊙ Under parallel operation of more than one rack connecting together, ripple of the output voltage may be higher than the SPEC at light load condition. It will go back to normal ripple level once the output load is more than 10%.

### 3.18 Series Operation

- ⊙ Higher output voltage can be acquired by connecting different racks in series.
- ⊙ The racks (RCP-1U<sub>□</sub>) connected in series should have the same single unit (RCP-1000-<sub>□</sub>) in each rack. Please refer to Figure 3-8 for the reference connection method.
- ⊙ Output current for series connection should not exceed the smallest rated current of all series connecting racks.
- ⊙ The difference in rise times of individual rack will lead to steps/stairs like turn on.
- ⊙ The output voltage after series connection should be less than 60Vdc [the requirement of SELV (Safety Extra Low Voltage) of IEC60950-1].
- ⊙ It is suggested to add on external diodes shown in Figure 3-8 to prevent the reverse voltage. Rating of these diodes should be higher than the total amount of output voltage and current.

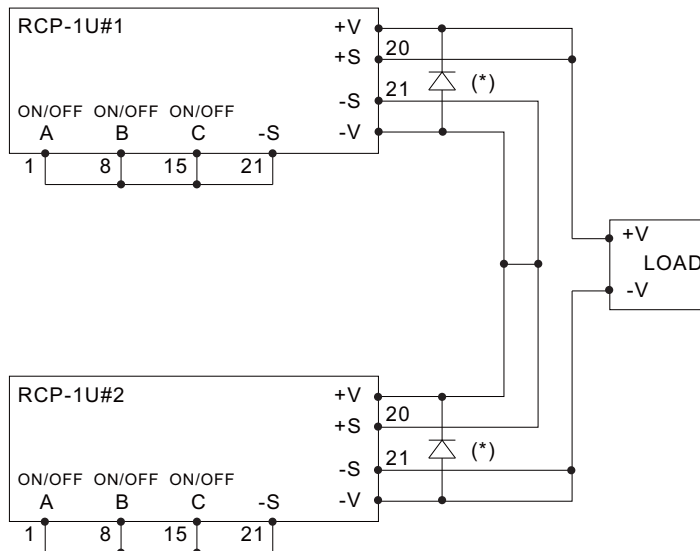

Figure 3-8: Operating in series connection

### 3.19 Auxiliary Output

- ⊙ Built-in 5V/0.3A auxiliary output for each rack.

### 3.20 Operation of I<sup>2</sup>C Data Bus (RCP-1000-C models only)

- ⊙ Models with built-in I<sup>2</sup>C function are available, please refer to the order information in section 1.3.
- ⊙ Through the I<sup>2</sup>C interface, users can obtain the operation information of the power supply, including.
  1. Output voltage, output current, and internal temperature of the power supply.
  2. Alarm and status information.
  3. Manufacturing and model information.

### 3.20.1 Block diagram of I<sup>2</sup>C data bus and related components

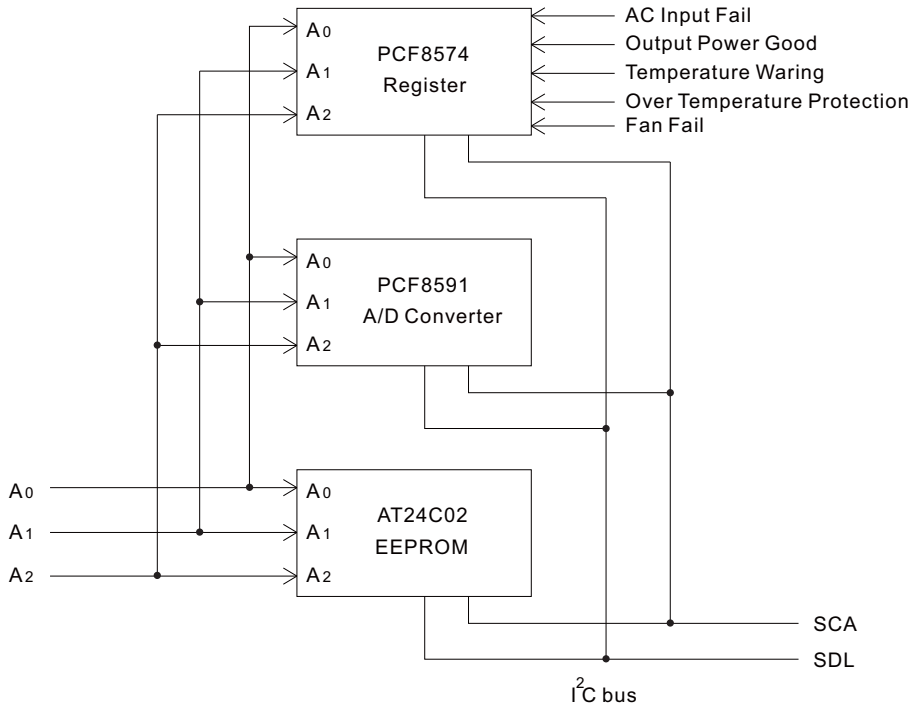

### 3.20.2 Address of I<sup>2</sup>C bus

Address is set by a 9-pole DIP switch on the rack. There are totally 3 RCP-1000 units in one RCP-1U<sub>□</sub> rack and each RCP-1000 has 3-pole as the addressing switch. (refer to the following diagram)

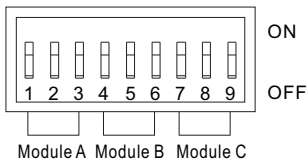

The "ON" position represents logic "0" while the "OFF" position represents logic "1". Switch 1~3, 4~6, 7~9 (low→high bit) can set RCP-1000 unit at position A, B, C in the rack respectively. Please refer to the following table.

A2	A1	A0	Module
3	2	1	A
6	5	4	B
9	8	7	C

For example, if we want to set the Module A of RCP-3K1U<sub>□</sub> -X as the first unit in the I<sup>2</sup>C data bus, Module B as the second, and Module C as the third, then we should set the 9-pole DIP switch on the rack as follow:

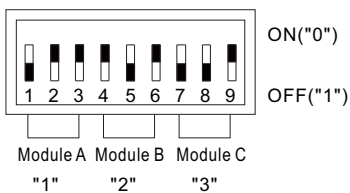

### 3.20.3 Digital status display function (Read Only)

Digital status functions are provided by a PCF8574, 8-bit register. It provides a single 8-bit word when read by the I<sup>2</sup>C controller. "Fault" is indicated by "1" while "Good" level is indicated by "0". The following table specifies the corresponding status for each bit:

Bit	Function	Good	Fault	Description
0	AC Input Fail	0	1	AC input normal / abnormal
1	Output Power Good / Fail	0	1	Output voltage is less than the SPEC
2	Temperature Warning	0	1	Internal temperature is over 60°C, PSU is still on
3	Over temperature Protection	0	1	Temperature exceeds normal operating limit, PSU turns off
4	Fan Fail Warning	0	1	Fan fail or stop working
5	Not Used	---	---	---
6	Not Used	---	---	---
7	Not Used	---	---	---

PCF8574 slave address:

Bit	7	6	5	4	3	2	1	0
Value	0	1	0	0	A2	A1	A0	R/W

Read : 1  
Write : 0

### 3.20.4 Analog status display function (Read Only)

1. Analog functions are provided by a single PFC8591, 4-channel 8-bit A/D converter. When this device is read by the serial bus controller, it provides an 8-bit word with the following information:

A/D Channel	Information
1	Output voltage
2	Output Current
3	Internal Temperature
4	Not Used

2. PCF8591 slave address

Bit	7	6	5	4	3	2	1	0
Value	1	0	0	1	A2	A1	A0	R/W

Read : 1  
Write : 0

3. PCF8591 control byte

Bit	7	6	5	4	3	2	1	0
Value	0	0	0	0	0	0		

0 0 : output voltage  
0 1 : output current  
1 0 : internal temperature

4. A/D scaling

The following scaling should be employed:

$$\text{Value (voltage, current, temperature)} = \text{Byte Value} * \text{Resolution}$$

Please refer to the following table for the scaling of the A/D channels for each model:

RCP-1000-12	Range	Resolution	Accuracy
Voltage	0~16V	0.0625V/bit	±5%
Current	0~80A	0.312A/bit	±10%
Temperature	0~100°C	0.391°C/bit	±3°C

RCP-1000-24	Range	Resolution	Accuracy
Voltage	0~33V	0.129V/bit	+3,-5%
Current	0~55A	0.215A/bit	±10%
Temperature	0~100°C	0.391°C/bit	±3°C

RCP-1000-48	Range	Resolution	Accuracy
Voltage	0~65V	0.254V/bit	+2,-5%
Current	0~30A	0.117A/bit	±10%
Temperature	0~100°C	0.391°C/bit	±3°C

For example, if the temperature reading value of RCP-1000-24 is "01010010", then convert to decimal value will be "82"  
82(value) \* 0.391(resolution) = 32.062°C

### 3.20.5 Function of EEPROM (Read Only)

A 256-byte EEPROM (AT24C02) includes on RCP-1000-C models which stores some information related to the model and manufacturing data. It is programmed at the factory with the data shown below:

Address	Bytes	Data
4	16	Manufacturer
20	20	Serial Number
40	16	Revision
56	16	Country of Production
72	16	Model Name
88	16	Output Voltage
104	16	Data of Production
254	2	Checksum

The slave EEPROM address:

Bit	7	6	5	4	3	2	1	0
Value	1	0	1	0	A2	A1	A0	R/W

Read : 1  
Write : 0

## 4. Notes on Operation

### 4.1 Installation Method

- ⊙ The RCP-1U<sub>□</sub> should be mounted in the 19" rack first.
- ⊙ Insert 1~3 pieces of RCP-1000 (with the same output voltage and current) into the RCP-1U<sub>□</sub> (refer to Figure 4-1).
- ⊙ Definition of module position: A is on the right, B is in the middle, and C is on the left (refer to Figure 4-1).
- ⊙ This is a power supply with built-in DC fan and please make sure that the ventilation is not blocked. It is suggested that there should be no barriers within 10cm of the ventilating holes.
- ⊙ Connect AC source to the AC input for A, B, C module position respectively depending on the RCP-1000 units assembled into the RCP-1U<sub>□</sub> rack.
- ⊙ Please refer to Table 4-1 about the suggested wire selection for input / output wirings.

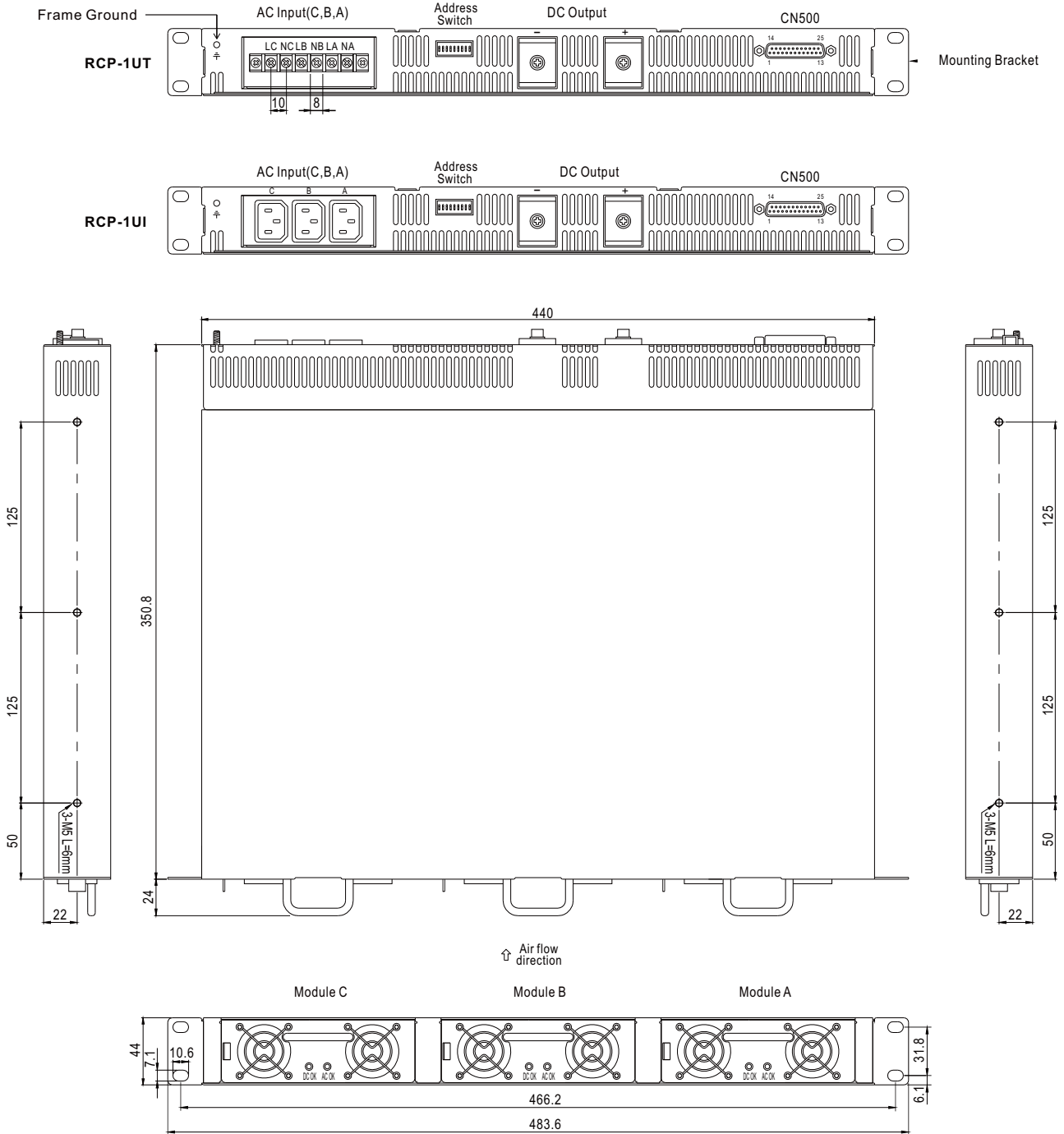

Figure 4-1: System assembly diagram of RCP series

Input /Output	Module	Current	Minimum Cross-section of Copper Wire	Maximum Current
110VAC	1 unit	12Arms	14AWG UL1015	12A
220VAC	1 unit	6Arms	18AWG UL1015	6A
+12VDC	1 unit	60Adc	8mm <sup>2</sup>	61A
	2 unit	120Adc	22mm <sup>2</sup>	115A
	3 unit	180Adc	38mm <sup>2</sup>	162A
+24VDC	1 unit	40Adc	3.5mm <sup>2</sup>	37A
	2 unit	80Adc	14mm <sup>2</sup>	88A
	3 unit	120Adc	22mm <sup>2</sup>	115A
+48VDC	1 unit	21Adc	2mm <sup>2</sup>	27A
	2 unit	42Adc	5.5mm <sup>2</sup>	49A
	3 unit	63Adc	8mm <sup>2</sup>	61A
Suggested selection for frequent used wirings			16AWG UL1015	8A
			12AWG UL1015	22A
			10AWG UL1015	35A
			30mm <sup>2</sup>	139A
			50mm <sup>2</sup>	190A
			60mm <sup>2</sup>	217A
			80mm <sup>2</sup>	257A
			100mm <sup>2</sup>	298A
			125mm <sup>2</sup>	344A
			150mm <sup>2</sup>	395A
200mm <sup>2</sup>	469A			
250mm <sup>2</sup>	556A			

Table 4-1: Suggested wire selection for input / output wirings

#### 4.2 Derating

⊙Output load derating is required for proper operation in high ambient temperature or at low AC input voltage. Please refer to Figure 4-2 for details.

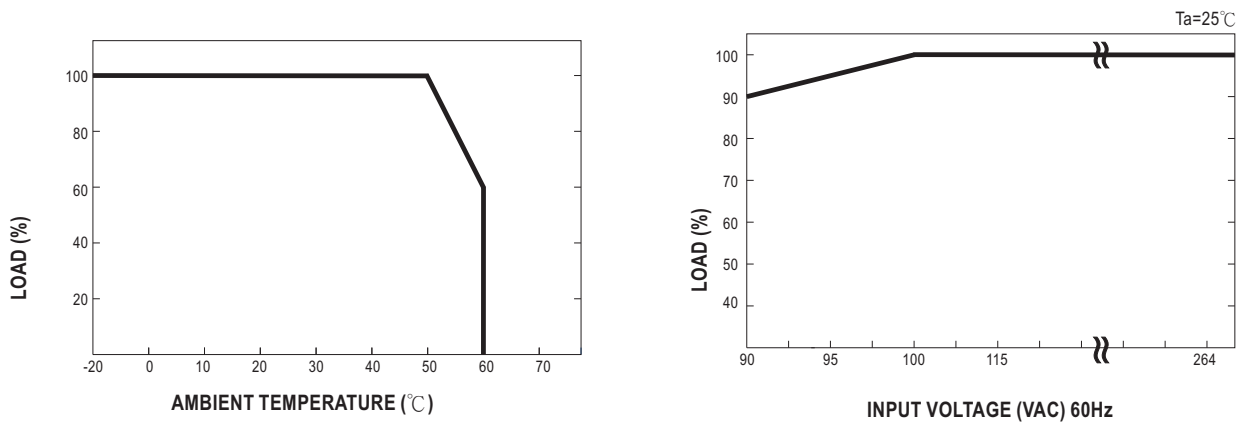

Figure 4-2: Output derating curves for RCP series

#### 4.3 Warranty

⊙Three years of global warranty is provided for RCP series under normal operation. Please do not change any component or modify the unit by yourself or MEAN WELL may reserve the right not to provide the complete warranty service.