

# **RCP-2000 / RKP-1U Instruction Manual**

<b>0.Safety Guidelines</b> .....	1
<b>1.Introduction of Series Models</b> .....	1
1.1 Introduction.....	1
1.2 Features.....	1
1.3 Order Information.....	1
1.4 Main Specification.....	2
<b>2.Mechanical Specification and Input / Output Terminals</b> .....	4
2.1 Mechanism of Single Unit.....	4
2.2 Mechanism of Whole Rack System.....	5
<b>3.Functions</b> .....	6
3.1 Input Voltage Range.....	6
3.2 Inrush Current Limiting.....	6
3.3 Output Power.....	7
3.4 Power Factor Correction (PFC).....	7
3.5 Output Voltage Adjustment.....	7
3.6 Fan Speed Control.....	7
3.7 Short Circuit Protection & Over Current Protection (O.C.P).....	7
3.8 Over Voltage Protection (O.V.P.).....	7
3.9 Over Temperature Protection (O.T.P.) and Over Temperature Alarm.....	8
3.10 AC OK Signal.....	8
3.11 DC OK Signal.....	8
3.12 Fan Malfunction Protection & Alarm signals.....	8
3.13 Remote Control.....	8
3.14 Remote Sense.....	8
3.15 Hot-Swap Operation.....	9
3.16 Parallel Operation.....	9
3.17 Series Operation.....	10
3.18 Auxiliary Output.....	11
3.19 PMBus communication interface.....	11
<b>4.Notes on Operation</b> .....	14
4.1 Installation Method.....	14
4.2 Derating.....	15
4.3 EMI test installation.....	15
4.4 Warranty.....	15



⊙Rack (RKP-1U□):

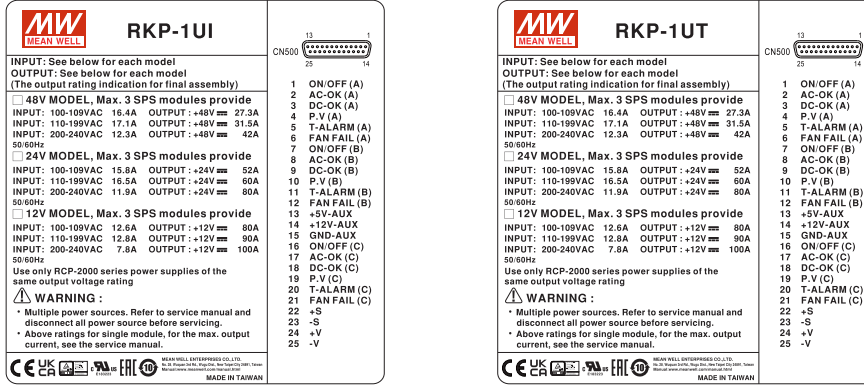

Figure 1-2: Safety labels of RKP-1U□

⊙Whole system (3 \* RCP-2000 + RKP-1U□):

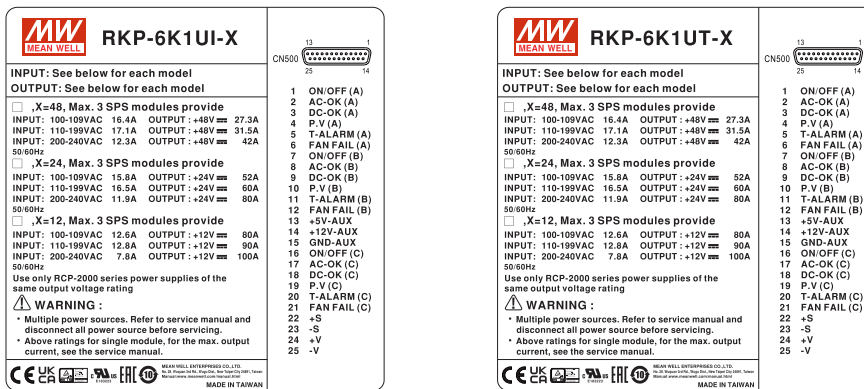

Figure 1-3: Safety labels of the whole RCP system

1.4 Main Specification

⊙Single unit

MODEL	RCP-2000-12	RCP-2000-24	RCP-2000-48	
OUTPUT	DC VOLTAGE	12V	24V	48V
	RATED CURRENT	100A	80A	42A
	CURRENT RANGE	0 ~ 100A	0 ~ 80A	0 ~ 42A
	RATED POWER	1200W	1920W	2016W
	RIPPLE & NOISE (max.) Note.2	150mVp-p	200mVp-p	300mVp-p
	VOLTAGE ADJ. RANGE	10.5 ~ 14V	21 ~ 28V	42 ~ 56V
	VOLTAGE TOLERANCE Note.4	±2.0%	±1.0%	±1.0%
	LINE REGULATION	±1.0%	±0.5%	±0.5%
	LOAD REGULATION	±1.0%	±0.5%	±0.5%
	SETUP, RISE TIME	1500ms, 60ms/230VAC at full load		
HOLD UP TIME (Typ.)	16ms/230VAC at 75% load    10ms/230VAC at full load			
INPUT	VOLTAGE RANGE Note.5,6	90 ~ 264VAC    250 ~ 320VDC		
	FREQUENCY RANGE	47 ~ 63Hz		
	POWER FACTOR (Typ.)	0.98/230VAC at full load		
	EFFICIENCY (Typ.)	86%	90.5%	92%
	AC CURRENT (Typ.)	13A/115VAC    7A/230VAC	16A/115VAC    10A/230VAC	16A/115VAC    10A/230VAC
	INRUSH CURRENT (Typ.)	COLD START 50A		
LEAKAGE CURRENT	<1.1mA / 230VAC			
PROTECTION	OVERLOAD	105 ~ 125% rated output power Protection type : Constant current limiting, unit will shut down o/p voltage after 5 sec. re-power on to recover		
	OVER VOLTAGE	14.7 ~ 17.5V	29.5 ~ 35V	57.6 ~ 67.2V
	OVER TEMPERATURE	Shut down o/p voltage, recovers automatically after temperature goes down		

◎Rack system

MODEL		RKP-6K1U□-12	RKP-6K1U□-24	RKP-6K1U□-48	
OUTPUT	RECTIFIER	RCP-2000-12	RCP-2000-24	RCP-2000-48	
	RACK SHELF	RKP-1UI or RKP-1UT			
	OUTPUT VOLTAGE	12V	24V	48V	
	MAX. OUTPUT CURRENT	300A	240A	126A	
	MAX. OUTPUT POWER <small>Note.7</small>	3600W	5760W	6048W	
INPUT	VOLTAGE RANGE <small>Note.6</small>	90 ~ 264VAC 127 ~ 370VDC			
	FREQUENCY RANGE	47 ~ 63Hz			
	AC CURRENT (Typ.)/PER MODULE	13A/115VAC 7A/230VAC	16A/115VAC 11A/230VAC	16A/115VAC 11A/230VAC	
	LEAKAGE CURRENT	<3.5mA / 230VAC			
FUNCTION	AUXILIARY POWER	5V @ 0.3A, 12V @ 0.8A			
	REMOTE ON-OFF CONTROL	By electrical signal or dry contact ON:short OFF:open			
	REMOTE SENSE	Compensate voltage drop on the load wiring up to 0.5V.			
	OUTPUT VOLTAGE PROGRAMMABLE	Adjustment of output voltage is allowable to 90 ~ 110% of nominal output voltage. Please refer to the Function Manual.			
	DC OK SIGNAL	The isolated TTL signal out, Please refer to the Installation Manual			
	AC OK SIGNAL	The isolated TTL signal out, Please refer to the Installation Manual			
	OVER TEMP WARNING	Logic " High" for over temperature warning, Please refer to the Installation Manual, isolated signal			
	FAN FAIL SIGNAL	The isolated TTL signal out, Please refer to the Installation Manual			
ENVIRONMENT	WORKING TEMP.	-35 ~ +70°C (Refer to "Derating Curve")			
	WORKING HUMIDITY	20 ~ 90% RH non-condensing			
	STORAGE TEMP., HUMIDITY	-40 ~ +85°C, 10 ~ 95% RH non-condensing			
	TEMP. COEFFICIENT	±0.03%/°C (0 ~ 50°C)			
	VIBRATION	10 ~ 500Hz, 2G 10min./1cycle, 60min. each along X, Y, Z axes			
SAFETY & EMC <small>(Note 5)</small>	SAFETY STANDARDS	UL62368-1, CSA C22.2 No. 62368-1, TUV BS EN/EN62368-1, EAC TP TC 004 approved			
	WITHSTAND VOLTAGE	I/P-O/P:3KVAC I/P-FG:2KVAC O/P-FG:0.7KVDC			
	ISOLATION RESISTANCE	I/P-O/P, I/P-FG, O/P-FG:100M Ohms / 500VDC / 25°C / 70% RH			
	EMC EMISSION	<b>Parameter</b>	<b>Standard</b>	<b>Test Level / Note</b>	
		Conducted	BS EN/EN55032 (CISPR32)	Class A	
		Radiated	BS EN/EN55032 (CISPR32)	Class A	
		Harmonic Current	BS EN/EN61000-3-2	-----	
		Voltage Flicker	BS EN/EN61000-3-3	-----	
	EMC IMMUNITY	BS EN/EN55035, BS EN/EN61000-6-2			
		<b>Parameter</b>	<b>Standard</b>	<b>Test Level / Note</b>	
		ESD	BS EN/EN61000-4-2	Level 3, 8KV air ; Level 2, 4KV contact	
Radiated		BS EN/EN61000-4-3	Level 3		
EFT / Burst		BS EN/EN61000-4-4	Level 3		
Surge		BS EN/EN61000-4-5	Level 4, 4KV/Line-Earth ; Level 3, 2KV/Line-Line		
Conducted		BS EN/EN61000-4-6	Level 3		
Magnetic Field		BS EN/EN61000-4-8	Level 4		
Voltage Dips and Interruptions	BS EN/EN61000-4-11	>95% dip 0.5 periods, 30% dip 25 periods, >95% interruptions 250 periods			
OTHERS	DIMENSION	Rack 350.8*482.6*44(L*W*H, with mounting bracket) ; 350.8*440*44(L*W*H, without mounting bracket)			
	PACKING	14.1Kg; 1pcs/14.1Kg/2.67CUFT			
NOTE	<p>1. All parameters NOT specially mentioned are measured at 230VAC input, rated load and 25°C of ambient temperature.</p> <p>2. Ripple &amp; noise are measured at 20MHz of bandwidth by using a 12" twisted pair-wire terminated with a 0.1uf &amp; 47uf parallel capacitor.</p> <p>3. Under parallel operation of more than one rack connecting together, ripple of the output voltage may be higher than the SPEC at light load condition. It will go back to normal ripple level once the output load is more than 10%.</p> <p>4. Tolerance : includes set up tolerance, line regulation and load regulation.</p> <p>5. The power supply is considered a component which will be installed into a final equipment. All the EMC tests are been executed by mounting the unit on a 720mm*360mm metal plate with 1mm of thickness. The final equipment must be re-confirmed that it still meets EMC directives. For guidance on how to perform these EMC tests, please refer to "EMI testing of component power supplies." (as available on <a href="http://www.meanwell.com">http://www.meanwell.com</a>)</p> <p>6. Derating may be needed under low input voltages. Please check the static characteristics for more details.</p> <p>7. Output of all the RCP-2000 modules are connected in parallel in the rack.</p> <p>8. Because of component tolerance, there is a possibility that some of the units connected in parallel will reach the overcurrent limit and others enter overload in turn when operating at full load condition. If overload conditions happen in parallel usage, it is suggested that derate the total output current by 10%.</p> <p>9. The ambient temperature derating of 3.5°C/1000m with fanless models and of 5°C/1000m with fan models for operating altitude higher than 2000m(6500ft).</p> <p>※ Product Liability Disclaimer : For detailed information, please refer to <a href="https://www.meanwell.com/serviceDisclaimer.aspx">https://www.meanwell.com/serviceDisclaimer.aspx</a></p>				

## 2.Mechanical Specification and Input / Output Terminals

### 2.1 Mechanism of Single Unit

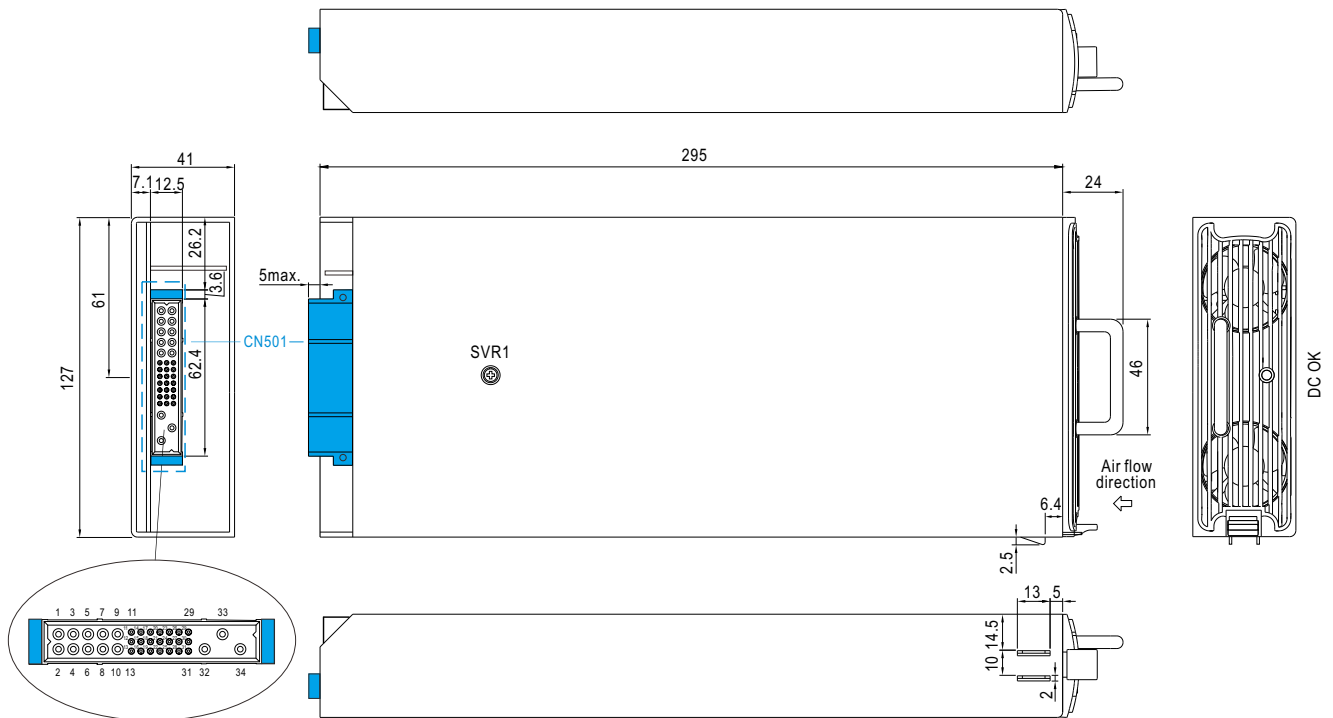

Figure 2-1

Input / Output Connector Pin No. Assignment(CN501) : Postronic PCIM34W13M400A1

Pin No.	Assignment	Pin No.	Assignment	Pin No.	Assignment	Pin No.	Assignment	Pin No.	Assignment	Pin No.	Assignment	Mating Housing
1,2,3,4	+V	12	DA	17	ON/OFF	22	NC	27	T-ALARM	32	FG $\perp$	Postronic PCIM34W13F400A1
5,6,7,8	-V	13	DB	18	A1	23	SDA	28	FAN-FAIL	33	AC/L	
9	-V(signal)	14	+S	19	A2	24	SCL	29	+5V-AUX	34	AC/N	
10	+V(signal)	15	-S	20	A3	25	AC-OK	30	+12V-AUX			
11	PV	16	A0	21	A4	26	DC-OK	31	GND-AUX			

## 2.2 Mechanism of Whole Rack System

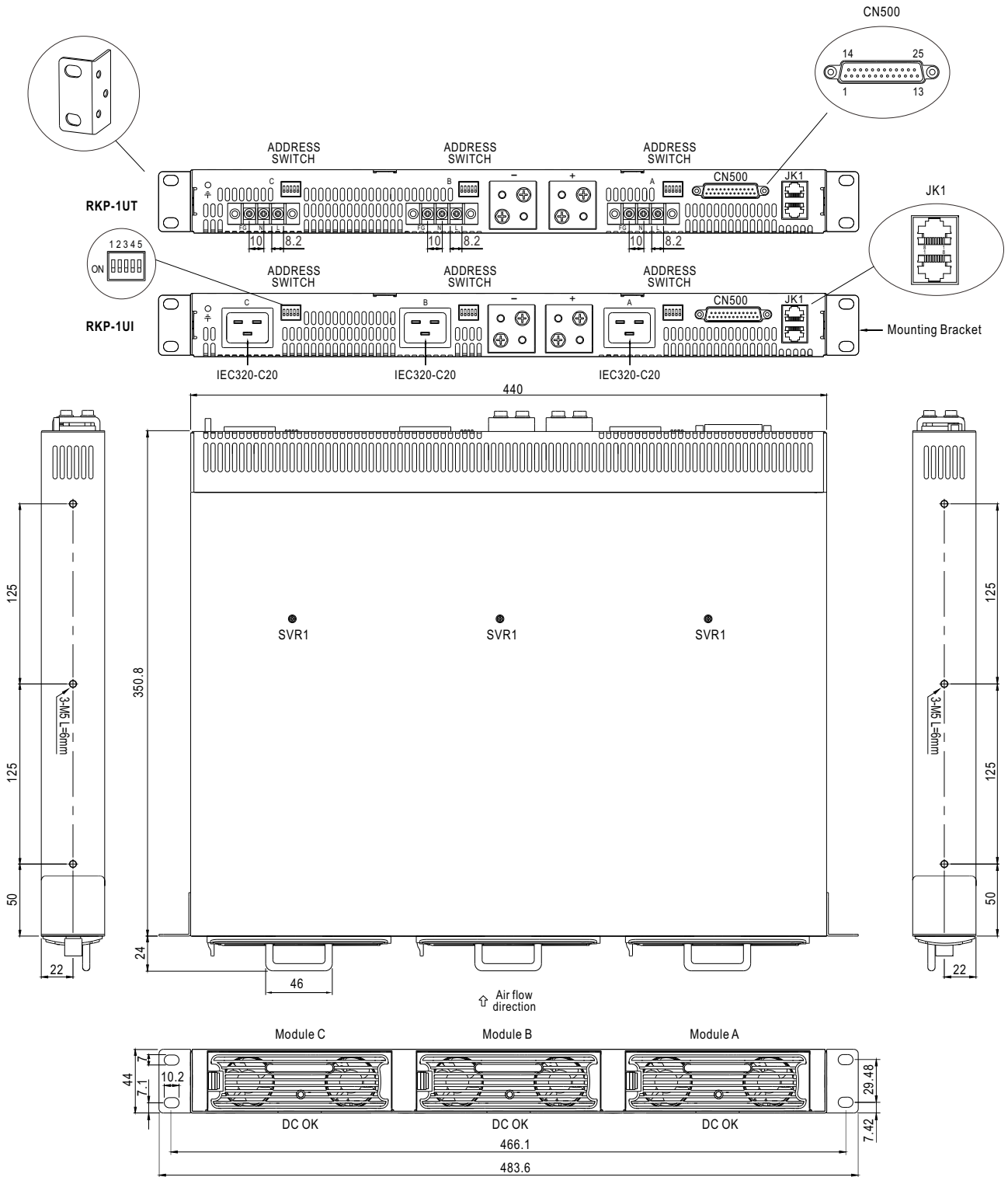

Figure 2-2

◎Connector Pin No. Assignment of CN500

Pin No.	Assignment	Pin No.	Assignment	Pin No.	Assignment	Pin No.	Assignment	Pin No.	Assignment
1	ON/OFF-A	6	FAN FAIL-A	11	T-ALARM-B	16	ON/OFF-C	21	FAN FAIL-C
2	AC-OK-A	7	ON/OFF-B	12	FAN FAIL-B	17	AC-OK-C	22	+S
3	DC-OK-A	8	AC-OK-B	13	+5V-AUX	18	DC-OK-C	23	-S
4	PV-A	9	DC-OK-B	14	+12V-AUX	19	PV-C	24	+V
5	T-ALARM-A	10	PV-B	15	GND-AUX	20	T-ALARM-C	25	-V

◎Connector Pin No. Assignment of JK1

Pin No.	Assignment	Pin No.	Assignment
1	DA	5	NC
2	DB	6	SDA
3	-V	7	SCL
4	CONTROL	8	GND-AUX

◎Description of CN500 in/out connection pins

Pin No.	Function	Description
1,7,16	ON/OFF	Each unit can separately turn the output on and off by electrical signal or dry contact between ON/OFF A,B,C(pin 1,7,16) and +5V-AUX(pin 13). Short (4.5 ~ 5.5V) : Power ON ; Open (0 ~ 0.5V) : Power OFF ; The maximum input voltage is 5.5V.
2,8,17	AC-OK	Low (0 ~ 0.5V) : When the input voltage is $\geq 87V_{rms}$ . High (4.5 ~ 5.5V) : when the input voltage in $\leq 75V_{rms}$ . The maximum sourcing current is 10mA and only for output. (Note.2)
3,9,18	DC-OK	High (4.5 ~ 5.5V) : When the $V_{out} \leq 80\pm 5\%$ . Low (0 ~ 0.5V) : When $V_{out} \geq 80\pm 5\%$ . The maximum sourcing current is 10mA and only for output. (Note.2)
4,10,19	PV	Connection for output voltage trimming. The voltage can be trimmed within its defined range. (Note.1)
5,11,20	T-ALARM	High (4.5 ~ 5.5V) : When the internal temperature (TSW1 or TSW2 open) exceeds the limit of temperature alarm. Low (0 ~ 0.5V) : When the internal temperature (TSW1 or TSW2 short) under the limit temperature. The maximum sourcing current is 10mA and only for output. (Note.2)
6,12,21	FAN FAIL	High (4.5 ~ 5.5V) : When the internal fan is failure. Low(0 ~ 0.5V) : When the internal fan is normal operating. The maximum sourcing current is 10mA and only for output. (Note.2)
13	+5V-AUX	Auxiliary voltage output, 4.3 ~ 5.3V, referenced to GND-AUX (pin 15). The maximum load current is 0.3A. This output has the built-in "Oring diodes" and is not controlled by the remote ON/OFF control.
14	+12V-AUX	Auxiliary voltage output, 10.8 ~ 13.2V, referenced to GND-AUX (pin 15). The maximum load current is 0.8A. This output has the built-in "Oring diodes" and is not controlled by the remote ON/OFF control.
15	GND-AUX	Auxiliary voltage output GND. The signal return is isolated from the output terminals (+V & -V).
22	+S	Positive sensing. The +S signal should be connected to the positive terminal of the load. The +S and -S leads should be twisted in pair to minimize noise pick-up effect. The maximum line drop compensation is 0.5V.
23	-S	Negative sensing. The -S signal should be connected to the negative terminal of the load. The -S and +S leads should be twisted in pair to minimize noise pick-up effect. The maximum line drop compensation is 0.5V.
24	+V	Positive output voltage. For local sense use only, can't be connected directly to the load.
25	-V	Negative output voltage. For local sense use only, can't be connected directly to the load.

◎Description of JK1 in/out connection pins

Pin No.	Function	Description
1,2	DA,DB	Differential digital signal for parallel control. (Note.1)
3	-V	Negative output voltage. For parallel control, can't be connected directly to the load.
4	CONTROL	Remote ON/OFF control pin used in the PMBus interface. (Note.2)
5	NC	Not use.
6	SDA	Serial Data used in the PMBus interface. (Note.2)
7	SCL	Serial Clock used in the PMBus interface. (Note.2)
8	GND-AUX	Auxiliary voltage output GND. The signal return is isolated from the output terminals (+V & -V).

Note.1: Non-isolated signal, referenced to the output terminals (-V).

Note.2: Isolated signal, referenced to GND-AUX.

### 3.Functions

#### 3.1 Input Voltage Range

◎Nominal input voltage range is AC 90~264V or DC 127~370V.

◎To insure proper operation, AC input should be within the pre-specified range. A wrong input will cause the power supply to operate improperly, lose the PFC function or even be damaged.

◎Since the RCP series have built-in active PFC circuit, there will be lower efficiency and output derating is required when operating at lower input voltage, referenced to 4.2 Derating.

#### 3.2 Inrush Current Limiting

◎Built-in inrush current limiting circuit.

◎An external switch, if needed, should have a current rating exceeding the maximum inrush current.

◎Since the inrush current limiting circuit mainly consists of thermistor and relay, after turning off the power supply, a 10 second cool down period is recommended before turning it back on. Inrush current will be much higher than the specified value if input thermistor is not allowed sufficient time to cool down.



### 3.3 Output Power

#### ◎Single Unit

RCP-2000-12 : 1200W (12V / 100A)

RCP-2000-24 : 1920W (24V / 80A)

RCP-2000-48 : 2016W (48V / 42A)

#### ◎Whole System

RKP-6K1U□-12 : 3600W (12V / 300A)

RKP-6K1U□-24 : 5760W (24V / 240A)

RKP-6K1U□-48 : 6048W (48V / 126A)

### 3.4 Power Factor Correction (PFC)

◎Built-in active power factor correction (PFC) function. When under full load and input voltage within the range of 90~230Vac, the PF value will be greater than 0.98; if the output is less than full load or the input voltage is higher than 230Vac, the PF value will be slightly less than 0.98.

### 3.5 Output Voltage Adjustment

#### 3.5.1 Adjustment of single unit

Output voltage of one RCP-2000 is adjustable through the potentiometer (SVR1, can be found under the small circular hole on top of the unit). Please use a cross-screwdriver with isolated holder to make the adjustment.

#### 3.5.2 Adjustment of single unit or the whole rack system

◎Output voltage can be adjusted between 90%~110% of the rated value by adding external voltage source. Please refer to Figure 3-1 for details.

◎When the output is tuned to a higher voltage, please notice that the load current should be decreased accordingly. The output wattage of each unit should not exceed its rated value under any circumstances.

#### 3.5.3 Adjustment of the whole rack system with a external 0~5Vdc source(using output voltage trimming function)

(1)Connect an external DC voltage source between PV (pin 4, 10, 19) and -V (pin 25) on CN500 connector, as shown in Figure 3-1.

(2)Output voltage can be adjusted between 90%~110% of the rated value. The characteristics of output voltage and external DC voltage source and the characteristics of output current and output voltage refer to Figure 3-2.

(3)When the output is tuned to a higher voltage, please notice that the load current should be decreased accordingly. The output wattage of each unit should not exceed its rated value under any circumstances.

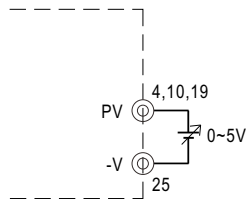

Figure 3-1 Connection for the external DC voltage source

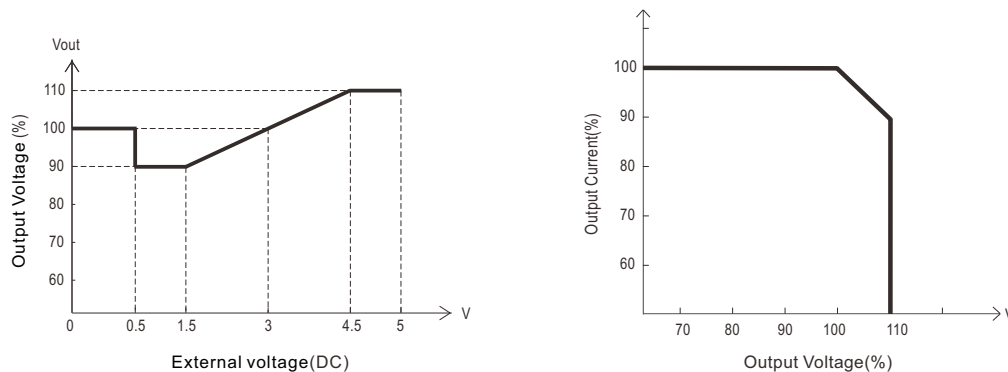

Figure 3-2

### 3.6 Fan Speed Control

◎Built-in fan speed control circuit. The fan speed will be adjusted according to the magnitude of output load.

### 3.7 Short Circuit Protection & Over Current Protection (O.C.P.)

◎Protection comes into effect at short circuit condition or >115%±10% of output rated current (constant current limiting mode). The PSU will automatically recover once the short circuit / over current condition is removed.

### 3.8 Over Voltage Protection (O.V.P.)

◎Built-in over voltage protection circuit for each RCP-2000 unit.

◎The O.V.P. triggering points are different for different output models. Please refer to the specification sheet for details.

◎The PSU shuts down when O.V.P. is triggered. To restart the power supply, please switch off the unit and then wait for 10 seconds before switching it back on.

### 3.9 Over Temperature Protection (O.T.P.) and Over Temperature Alarm

- ⊙ Built-in 2 sets of over temperature protection circuit. When the internal temperature exceeds the threshold value, the power supply will shut down automatically (the built-in fan will still operate to cool down the PSU). You should switch off the AC input and remove all possible causes of overheating, and then let the power supply cool down to normal working temperature (needs about 10 minutes~1 hour) before turning it back on.
- ⊙ When the internal temperature reaches 60°C, the limit of temperature alarm, the red LED on the front panel will flicker and there will be an alarm signal sent out through the PM bus interface (refer to 3.19). Even so, the power supply is still normal operating.
- ⊙ When the internal temperature is within safe range, there will be a "Low" signal (0~0.5V) between "T-ALARM" and "GND-AUX" on CN500 connector; When the internal temperature exceeds the threshold value, there will be a "High" signal (4.5~5.5V) between "T-ALARM" and "GND-AUX" on CN500 connector.
- ⊙ The sourcing current is 10mA and only for output.

### 3.10 AC OK Signal

- ⊙ Built-in AC input voltage detecting circuit.
- ⊙ Only when AC input voltage  $\geq 87V_{rms}$ , the output voltage will be able to work properly and there will be a "Low" signal (0~0.5V) between "AC-OK" and "GND-AUX" on CN500 connector.
- ⊙ When AC input voltage  $\leq 75V_{rms}$ , the output voltage will be shut down and the red LED on the front panel will light up. In the mean time, there will be a "High" signal (4.5~5.5V) between "AC-OK" and "GND-AUX" on CN500 connector.
- ⊙ The sourcing current is 10mA and only for output.

### 3.11 DC OK Signal

- ⊙ Built-in DC output voltage detecting circuit.
- ⊙ When DC output voltage  $\geq 80\pm 5\%$  of the rated value, the green LED on the front panel will light up (see Figure 3-3). In the mean time, there will be a "Low" signal (0~0.5V) between "DC-OK" and "GND-AUX" on CN500 connector.
- ⊙ When DC output voltage  $\leq 80\pm 5\%$  of the rated value, the red LED on the front panel will be turned on. In the mean time, there will be a "High" signal (4.5~5.5V) between "DC-OK" and "GND-AUX" on CN500 connector.
- ⊙ The sourcing current is 10mA and only for output.

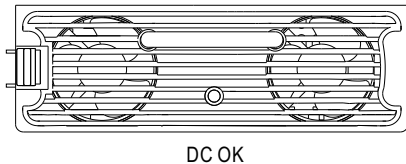

Figure 3-3: Front panel of RCP-2000

### 3.12 Fan Malfunction Protection & Alarm Signals

- ⊙ Built-in fan malfunction protection circuit. When the DC fan stop operating (fan lock or wire broken), the output will be shutdown. In the mean time, there will be a "High" signal (4.5~5.5V) between "FAN FAIL" and "GND-AUX" on CN500 connector. Please switch off the AC source and send back to our local distributor or MEAN WELL for repair.
- ⊙ The sourcing current is 10mA and only for output.

### 3.13 Remote Control

- ⊙ Built-in remote ON/OFF control circuit. Please refer to Figure 3-4 for single unit or whole rack system control.
- ⊙ Notice that the "ON/OFF" and "+5V-AUX" pins on CN500 should be connected together in order to let the PSU operate properly. If they are not connected, the output voltage will be shut down.
- ⊙ The maximum input voltage is 5.5V.

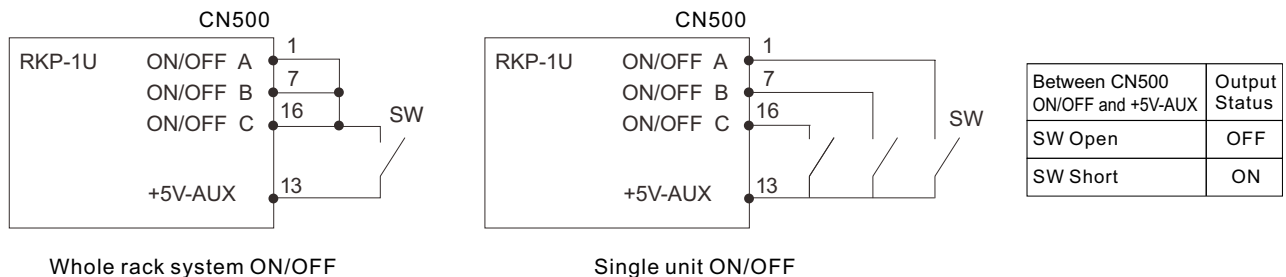

Figure 3-4 Connection for remote ON/OFF control operation

### 3.14 Remote Sense

- ⊙ Built-in remote sense circuit that can compensate voltage drop, up to 0.5V.
- ⊙ When using this function, the sensing wires should either be twisted or shielded to prevent external noise interference (refer to Figure 3-5).
- ⊙ The voltage drop across the output wires must be limited to less than 0.5V. Also heavy wires with adequate current rating should be used between +V/-V and the load. Please firmly connect the output wires to prevent them from loosening, or the power supply may be out of order.
- ⊙ Notice: It is required to use the "Remote Sense" function to let the PSU work properly. If not, the "Local Sense" is still required that "+S" should be shorted to "+V" and "-S" to "-V" as Figure 3-6. Or the output voltage will be too high, which may trigger the over voltage protection.

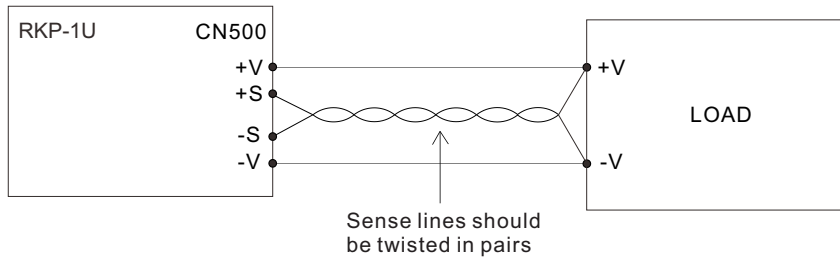

Figure 3-5 Connection for using the "Remote Sense" function

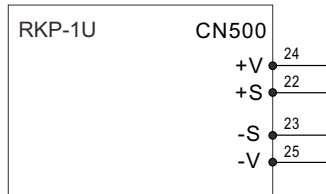

Figure 3-6 Connection for using the "Local Sense" function

### 3.15 Hot-Swap Operation

- ⊙ Built-in "Oring MOSFET" in each RCP-2000 unit that the single unit can be hot-swapped without turning off the AC source providing to the whole rack system.
- ⊙ Insert the RCP-2000 unit: Grasp the handle and push inside the rack through the rail.
- ⊙ Pull out the RCP-2000 unit: Press the clip shown in Figure 3-7 and pull the unit out.

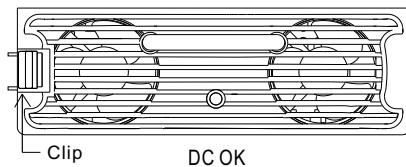

Figure 3-7 Location of the "clip" on RCP-2000 unit

Note : Please use adequate force to insert power supplies into the rack.

Slamming power supplies into the rack can damage the connectors both on the rear of the supplies and inside the rack.

### 3.16 Parallel Operation

#### 3.16.1 Operation of single rack

- ⊙ Internal parallel operation in single rack is only suitable for using the same RCP-2000 unit (single unit with the same output voltage and current).
- ⊙ There is a built-in parallel connection circuit in each rack (RKP-1U□). Once RCP-2000 units are inserted into the rack then the parallel connection is done.
- ⊙ Under parallel operation, the connection of other functions can refer to section 3.13 & 3.14.

#### 3.16.2 Operation of three racks in parallel

- ⊙ Parallel operation is only suitable for the same RCP-2000 units (single unit with the same output voltage and current) located in up to 3 racks. Up to 9 identical units can be operated in parallel.
- ⊙ Because of component tolerance, there is a possibility that some of units connected in parallel will reach an overcurrent limit then overloading the other units when operating at full load condition. If overload conditions happen in parallel usage, it is suggested that derate the total output current by 10%. For example: RCP-2000-24 × 9 connected in parallel (in 3 racks), the total output current should be changed to  $80A \times 9 \text{ unit} \times 0.9 = 648A$ .
- ⊙ Adjust the output voltage of all the single units to the value you need and minimize the differences to less than 1% among one another before operating in parallel.
- ⊙ Parallel the racks before connecting to the load (refer to Figure 3.8). Do not connect each rack to the load separately!
- ⊙ The control signals DA, DB, -V should also be connected in parallel. (refer to Figure 3.8)
- ⊙ Twisted wires should be used for the wiring of +S and -S. To avoid the interference, the twisted wires should not touch the load wires. (refer to Figure 3.8)
- ⊙ A too long cable length might be with a higher amount of noise that affects rack units' proper operation in parallel. To reduce the noise, installing termination resistors, an accessory, to the unused JK1s is recommended.

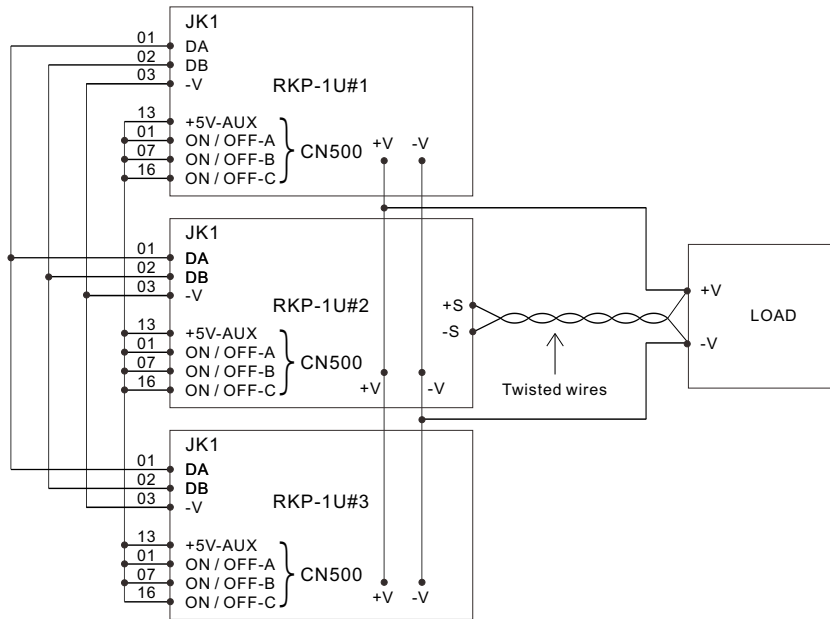

Figure3-8 Three racks connected in parallel

⊙When operating more than one rack unit in parallel, ripples of the output voltage might be higher than that specified in the spec at light load condition. It will go back to normal ripple level once the drawn load is more than one-tenth of rated wattage.

### 3.17 Series Operation

- ⊙Higher output voltage can be acquired by connecting different racks in series.
- ⊙The racks (RKP-1U□) connected in series should have the same single unit (RCP-2000-□) in each rack. Please refer to Figure 3-9 for the reference connection method.
- ⊙Output current for series connection should not exceed the smallest rated current of all series connecting racks.
- ⊙The difference in rise times of individual rack might lead to steps/stairs during initial set-up.
- ⊙The output voltage after series connection should be less than 60Vdc [the requirement of SELV(Safety Extra Low Voltage) of IEC60950-1].
- ⊙It is suggested to add on external diodes (\*) shown in Figure 3-9 to prevent the reverse voltage. Rating of these diodes should be higher than the total amount of output voltage and current.

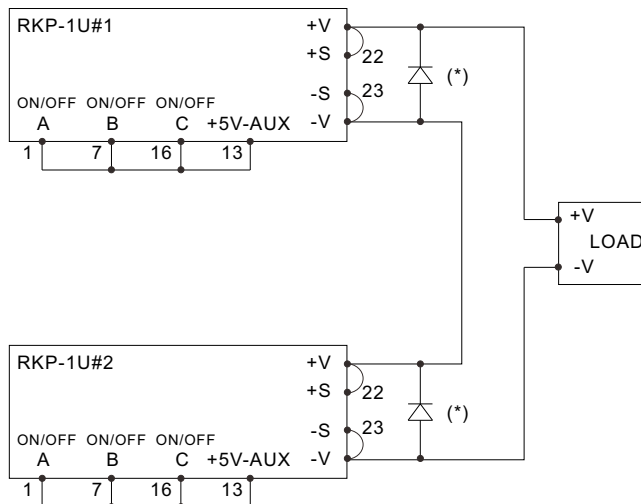

Figure 3-9 Operating in series connection

### 3.18 Auxiliary Output

⊙ Built-in 5V/0.3A and 12V/0.8A auxiliary output for each rack.

### 3.19 PMBus communication interface

⊙ RCP-2000 is compliant with PMBus Rev. 1.1, the maximum communication speed is 100KHz, which allows up to 9 units to be identified and controlled over the bus.

⊙ Through the PMBus interface, users can obtain the operation information of the power supply, including

1. Output voltage, output current, and internal temperature of the power supply.
2. Alarm and status information.
3. Manufacturing and model information.

⊙ RKP-CMU1 is a monitor unit particularly designed for rack power. Users can easily monitor operating parameters of each power supply unit by means of LCD interface or a computer.

⊙ Maximum number that can be monitored by master controller in communication shall be 9 power supplies.

#### 3.19.1 PMBus Device Addressing

⊙ Each RCP-2000 unit should have their unique and own device address to communicate over the PMBus. 7-bit address setting pins are used to assign a device address for a RCP-2000 unit, as the description shows below.

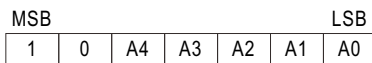

A0~A4, five of the bits, can be set via a 5-pole DIP switch on the rear panel of a rack unit. The "ON" position represents logic "0" while the "OFF" position represents logic "1".

There are 32 different addresses available to be assigned by the DIP switch. The switch settings show as below.



Module No.	Device address				
	A0	A1	A2	A3	A4
	DIP switch position				
	1	2	3	4	5
0	ON	ON	ON	ON	ON
1	OFF	ON	ON	ON	ON
2	ON	OFF	ON	ON	ON
3	OFF	OFF	ON	ON	ON
4	ON	ON	OFF	ON	ON
5	OFF	ON	OFF	ON	ON
6	ON	OFF	OFF	ON	ON
7	OFF	OFF	OFF	ON	ON
8	ON	ON	ON	OFF	ON
9	OFF	ON	ON	OFF	ON
10	ON	OFF	ON	OFF	ON
11	OFF	OFF	ON	OFF	ON
12	ON	ON	OFF	OFF	ON
13	OFF	ON	OFF	OFF	ON
14	ON	OFF	OFF	OFF	ON
15	OFF	OFF	OFF	OFF	ON

Module No.	Device address				
	A0	A1	A2	A3	A4
	DIP switch position				
	1	2	3	4	5
16	ON	ON	ON	ON	OFF
17	OFF	ON	ON	ON	OFF
18	ON	OFF	ON	ON	OFF
19	OFF	OFF	ON	ON	OFF
20	ON	ON	OFF	ON	OFF
21	OFF	ON	OFF	ON	OFF
22	ON	OFF	OFF	ON	OFF
23	OFF	OFF	OFF	ON	OFF
24	ON	ON	ON	OFF	OFF
25	OFF	ON	ON	OFF	OFF
26	ON	OFF	ON	OFF	OFF
27	OFF	OFF	ON	OFF	OFF
28	ON	ON	OFF	OFF	OFF
29	OFF	ON	OFF	OFF	OFF
30	ON	OFF	OFF	OFF	OFF
31	OFF	OFF	OFF	OFF	OFF

Table 3-1

#### 3.19.2 PMBus Command List

⊙ Table 3-2 shows the command list of RCP-2000. It is compliant with industry standard PMBus protocol Rev. 1.1. For more details about the information, you can refer to PMBus official web (<http://pmbus.org/specs.html>).

Command Code	Command Name	Transaction Type	# of data Bytes	Description
01h	OPERATION	R/W Byte	1	Remote ON/OFF control
02h	ON_OFF_CONFIG	Read Byte	1	ON/OFF function configuration
19h	CAPABILITY	Read Byte	1	Capabilities of a PMBus device
20h	VOUT_MODE	R Byte	1	Define data format for output voltage (format: Linear, N=-9)
21h	VOUT_COMMAND	R Word	2	Output voltage setting value (format: Linear, N=-9)

Command Code	Command Name	Transaction Type	# of data Bytes	Description
22h	VOUT_TRIM	R/W Word	2	Output voltage trimming value (format: Linear, N= -9)
46h	IOUT_OC_FAULT_LIMIT	R/W Word	2	Output overcurrent setting value (format: Linear, N= -3)
47h	IOUT_OC_FAULT_RESPONSE	R Byte	1	Define protection and response when an output overcurrent fault occurred
79h	STATUS_WORD	R Word	2	Summary status reporting
7Ah	STATUS_VOUT	R Byte	1	Output voltage status reporting
7Bh	STATUS_IOUT	R Byte	1	Output current status reporting
7Ch	STATUS_INPUT	R Byte	1	AC input voltage status reporting
7Dh	STATUS_TEMPERATURE	R Byte	1	Temperature status reporting
80h	STATUS_MFR_SPECIFIC	R Byte	1	Manufacture specific status reporting
81h	STATUS_FANS_1_2	R Byte	1	Fan1 and 2 status reporting
88h	READ_VIN	R Word	2	AC input voltage reading value (format: Linear, N=-1)
8Bh	READ_VOUT	R Word	2	Output voltage reading value (format: Linear, N= -9)
8Ch	READ_IOUT	R Word	2	Output current reading value (format: Linear, N= -3)
8Dh	READ_TEMPERATURE_1	R Word	2	Temperature 1 reading value (format: Linear, N= -3)
90h	READ_FAN_SPEED_1	R Word	2	Fan speed 1 reading value (format: Linear, N= 5)
91h	READ_FAN_SPEED_2	R Word	2	Fan speed 2 reading value (format: Linear, N= 5)
98h	PMBUS_REVISION	R Byte	1	The compliant revision of the PMBus (default: 11h for Rev. 1.1)
99h	MFR_ID	Block Read	12	Manufacturer's name
9Ah	MFR_MODEL	Block Read	12	Manufacturer's model name
9Bh	MFR_REVISION	Block Read	6	Firmware revision
9Ch	MFR_LOCATION	Block R/W	3	Manufacturer's factory location
9Dh	MFR_DATE	Block R/W	6	Manufacture date. (format: YYMMDD)
9Eh	MFR_SERIAL	Block R/W	12	Product serial number

Table 3-2

### 3.19.3 PMBus range and tolerance

©Display parameters

PMBus command	Model	Range	Tolerance
READ_VIN	ALL	0 ~ 264V	±10V
READ_VOUT	12V	0 ~ 14V	±3%
	24V	0 ~ 28V	±3%
	48V	0 ~ 56V	±3%
READ_IOUT (Note. 1)	12V	0 ~ 125A	±5A
	24V	0 ~ 100A	±4A
	48V	0 ~ 50A	±2A
READ_TEMPERATURE_1	ALL	0 ~ 100°C	±5°C
READ_FAN_SPEED_1	ALL	0 ~ 20000RPM	±2000RPM
READ_FAN_SPEED_2	ALL	0 ~ 20000RPM	±2000RPM

Table 3-3

©Control parameters

PMBus command	Model	Adjustable range	Tolerance	Default
OPERATION	ALL	00h(OFF) / 80h(ON)	N/A	80h(ON)
VOUT_COMMAND (Note. 2)	12V	12V	N/A	12V
	24V	24V	N/A	24V
	48V	48V	N/A	48V
VOUT_TRIM (Note. 2)	12V	-1.5 ~ 2V	±5%	0V
	24V	-3 ~ 4V	±5%	0V
	48V	-6 ~ 8V	±5%	0V
IOUT_OC_FAULT_LIMIT	12V	30 ~ 112A	±5A	112A
	24V	24 ~ 89.5A	±4A	89.5A
	48V	12.62 ~ 47A	±3A	47A

Table 3-4

Note:

1.READ\_IOUT readings will be displayed ZERO Amps when output current is less than values in the below table.

Model	Minimum readable current
12V	4A±1A
24V	3.2A±1A
48V	1.7A±1A

Table 3-5

2.Output voltage is the sum of the values of VOUT\_COMMAND and VOUT\_TRIM. The value of VOUT\_COMMAND is fixed and cannot be altered, while the value of VOUT\_TRIM can be changed and trimmed. Take RCP-2000-12 for example, the VOUT\_COMMAND is fixed at 12V and the VOUT\_TRIM can be trimmed to -1.5, so the total output voltage is 10.5V. Adjustment range of each model shows below:

Model	Adjustment range
12V	10.5 ~ 14V
24V	21 ~ 28V
48V	42 ~ 56V

Table 3-6

**3.19.4 PMBus monitoring notes**

1.RKP-CMU1 can be used to remotely control RCP-2000 by the command of "PMBus OPERATION" or connecting up the physical pins of "PMBus CONTROL" and "RKP-1U ON/OFF" to +5V-AUX. In order to let RKP-CMU1 operate properly, the pin of RKP-1U ON/OFF connecting to +5V-AUX should be opened. Refer to Table 3-6 for the output control of RCP-2000 shows.

RKP-1U ON/OFF pin	PMBus CONTROL pin	PMBus OPERATION command	RCP-2000 output state
Connect to +5V-AUX	Open	80h (ON)	ON
Connect to +5V-AUX	Connect to +5V-AUX	80h (ON)	ON
Open	Open	80h (ON)	OFF
Open	Connect to +5V-AUX	80h (ON)	ON
Don't care	Don't care	00h (OFF)	OFF

Table 3-7

- If RCP-2000 units is restarted, the parameters of Bus voltage and PSU current you have set will return to the initial/default values, whereas if RCP-2000 units is connected with a RKP-CMU1 unit, the restarted RCP-2000s will be loaded the previous set parameters by the RKP-CMU1 automatically.
- If PMBus is offline such as RKP-CMU1 shutdown, the parameters of remote ON/OFF control, Bus voltage, and PSU current you have set will return to the initial/default values.
- Using the RKP-CMU1 to reduce PSU current will just limit output current of RCP-2000 units and will not trigger their over-current alarm. Take RCP-2000-48 as an example, the over-current protection threshold is 47A when operating at 230Vac. If you set PSU current to 40A, then the maximum output current will be 40A. It is less than 47A, so its over-current alarm will not be triggered.
- If PSU current you set is higher than the auto de-rating value of the rack PSU when operating at a low AC input voltage, it will trigger the de-rated over-current protection. Take RCP-2000-48 as an example, the over-current protection threshold decreases by 25%, from 47A to 35.25A, when operating at 100Vac. If you set PSU current to 40A, it will trigger over-current alarm due to the lower over-current protection threshold (35.25A).

## 4. Notes on Operation

### 4.1 Installation Method

- ⊙ Mount the rack unit in a 19" rack before operating.
- ⊙ Insert 1~3 pieces of RCP-2000 (with the same output voltage and current) into the RKP-1U□ (refer to Figure 4-1).
- ⊙ Definition of module position: A is on the right, B is in the middle, and C is on the left (refer to Figure 4-1).
- ⊙ This unit is equipped with built-in DC fans and require clearance for cooling. There should be no barriers within 10cm of the ventilation holes.
- ⊙ Connect the AC inputs of A, B, and C to AC source. module position respectively depending on the RCP-2000 units assembled into the RKP-1U□ rack.
- ⊙ Please refer to Table 4-1 about the suggested wire selection for input / output wirings.

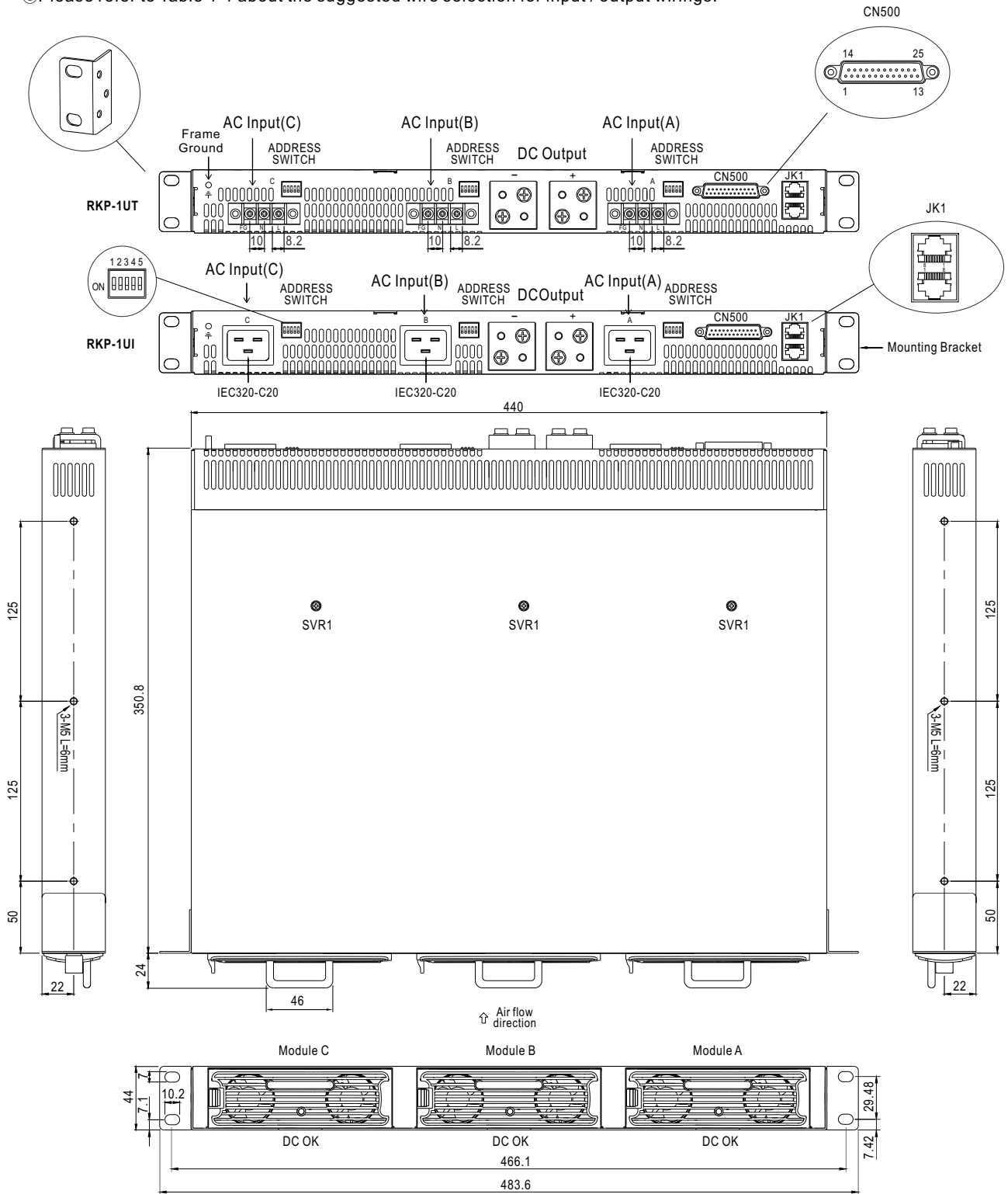

Figure 4-1 System assembly diagram of RCP series



Input /Output	Module	Current	Minimum Cross-section of Copper Wire	Maximum Current
115VAC	1 unit	16Arms	14AWG UL1015	12A
230VAC	1 unit	10Arms	18AWG UL1015	6A
+12VDC	1 unit	100Adc	22mm <sup>2</sup>	115A
	2 unit	200Adc	60mm <sup>2</sup>	217A
	3 unit	300Adc	125mm <sup>2</sup>	344A
+24VDC	1 unit	80Adc	22mm <sup>2</sup>	115A
	2 unit	160Adc	50mm <sup>2</sup>	190A
	3 unit	240Adc	80mm <sup>2</sup>	240A
+48VDC	1 unit	42Adc	5.5mm <sup>2</sup>	49A
	2 unit	84Adc	22mm <sup>2</sup>	115A
	3 unit	126Adc	30mm <sup>2</sup>	139A
Other commonly used wiring			16AWG UL1015	8A
			12AWG UL1015	22A
			10AWG UL1015	35A
			30mm <sup>2</sup>	139A
			50mm <sup>2</sup>	190A
			60mm <sup>2</sup>	217A
			80mm <sup>2</sup>	257A
			100mm <sup>2</sup>	298A
			125mm <sup>2</sup>	344A
			150mm <sup>2</sup>	395A
200mm <sup>2</sup>	469A			
250mm <sup>2</sup>	556A			

Table 4-1 Suggested wire selection for input / output wirings

#### 4.2 Derating

©When RCP-2000 units are operating in high ambient temperature or at a low AC input voltage, these units will de-rate their output current automatically to protect themselves, as shown in Figure 4-2.

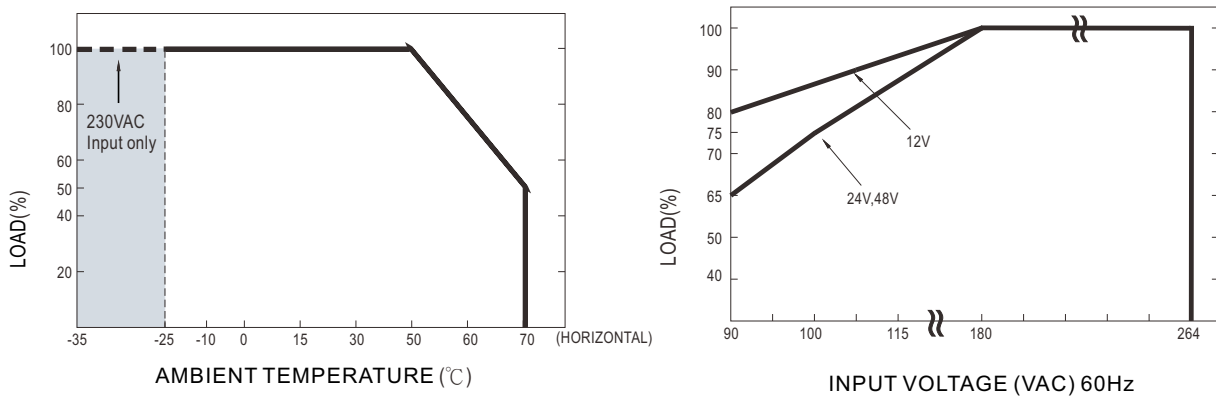

Figure 4-2 Output derating curves for RCP 2000 series

#### 4.3 EMI test installation

©EMI radiation test is greatly affected by wiring, attaching an EMI suppressor(ferrite core) to the AC cable as close as possible to the AC inlet to reduce noise is recommend. There are suggested components for reducing EMI radiation interference including TDK HF70RU26\*29\*13S, NEC ESD-SR-250H, and EROCORE FH29.7\*13\*25.9.

#### 4.4 Warranty

©Three years of global warranty is provided for RCP-2000 series/ RKP-1U under normal operation. Please do not change any component or modify the unit by yourself or MEAN WELL may reserve the right not to provide the complete warranty service.