

Features

Unregulated Converter

- Medical grade DC/DC converter
- 250VAC working, 2MOPP up to 5000m altitude
- 5.2kVDC/1 minute isolation
- Single or dual outputs
- -40°C up to +95°C operating temperature
- Medical certified (3rd Ed. safety, 4th Ed. EMC)



REM2

**2 Watt
SIP8
Single and Dual
Output**



CAN/CSA-C22.2 No. 60601-1:14 certified
ANSI/AAMI ES60601-1 certified
IEC/EN60601-1 certified
IEC/EN62368-1 certified
EN60601-1-2 compliant
EN55011 compliant
CB report

Description

The board-mount REM2 series complements the REM1 series by offering a 2W medical grade DC/DC converter in a compact SIP8 package. The REM2 features reinforced 5.2kVDC/1 minute isolation and 2MOPP/250VAC working voltage at 5000m. It offers single and dual outputs with up to 85% efficiency. The operating temperature range is -40°C up to +80°C without derating, and up to +95°C with 50% load. The converter is compliant to Class A/B EMC and 60601-1-2 (4th Ed.) medical EMC using a simple external LC filter. The REM2 is certified to CB, IEC/EN and ANSI/AAMI 60601 third edition medical safety standards (pending) and comes with a 5 year warranty.

Selection Guide

Part Number	nom. Input Voltage [VDC]	Output Voltage [VDC]	Output Current [mA]	Efficiency typ. ⁽¹⁾ [%]	Max. Capacitive Load ⁽²⁾ [µF]
REM2-xx3.3S	3.3 / 5 / 12 / 15 / 24	3.3	606	77	1000
REM2-xx05S	3.3 / 5 / 12 / 15 / 24	5	400	79	1000
REM2-xx09S	3.3 / 5 / 12 / 15 / 24	9	222	84	470
REM2-xx12S	3.3 / 5 / 12 / 15 / 24	12	167	82	330
REM2-xx3.3D	5 / 15	±3.3	±303	79	680
REM2-xx05D	3.3 / 5 / 12 / 15 / 24	±5	±200	82	680
REM2-xx12D	3.3 / 5 / 12 / 15 / 24	±12	±84	85	150

Notes:

Note1: Efficiency is tested at nominal input and full load at +25°C ambient
Note2: Max Cap Load is tested at minimum input and full resistive load

Model Numbering



Ordering Examples

REM2-0505S = 5V_{in} 5V_{out} Single
REM2-2412D = 24V_{in} 12V_{out} Dual

Specifications (measured @ Ta= 25°C, nom. Vin, full load unless otherwise stated)

BASIC CHARACTERISTICS				
Parameter	Condition	Min.	Typ.	Max.
Internal Input Filter				capacitor
Input Voltage Range			±10%	
Input Current	3.3VDC		750mA	
	5VDC		520mA	
	nom. Vin = 12VDC		210mA	
	15VDC		175mA	
	24VDC		110mA	
Quiescent Current	3.3VDC		55mA	
	5VDC		46mA	
	nom. Vin = 12VDC		24mA	
	15VDC		18mA	
	24VDC		10mA	
Minimum Load		0%		
Internal Operating Frequency		20kHz		
Output Ripple and Noise ⁽³⁾	20MHz BW			150mVp-p

Notes:

Note3: Measurements are made with a 0.1µF MLCC across output (low ESR)

Efficiency vs. Load

REM2-xx3.3S(D)

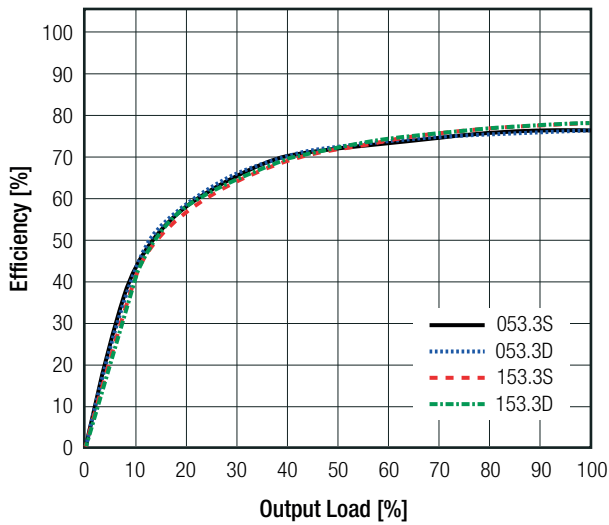

REM2-xx05S(D)

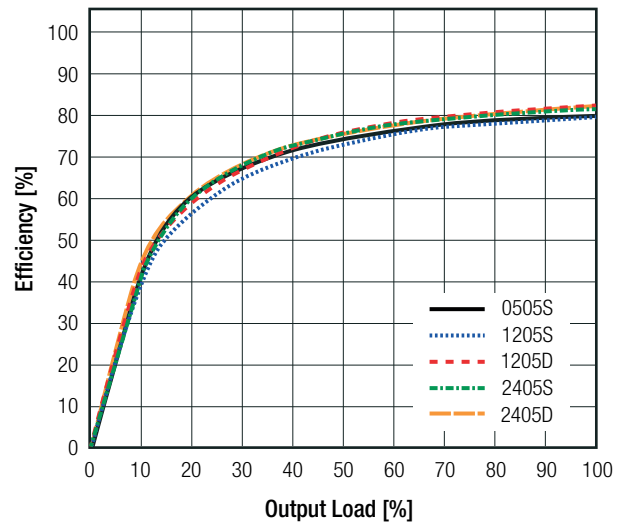

REM2-3.312S(D)

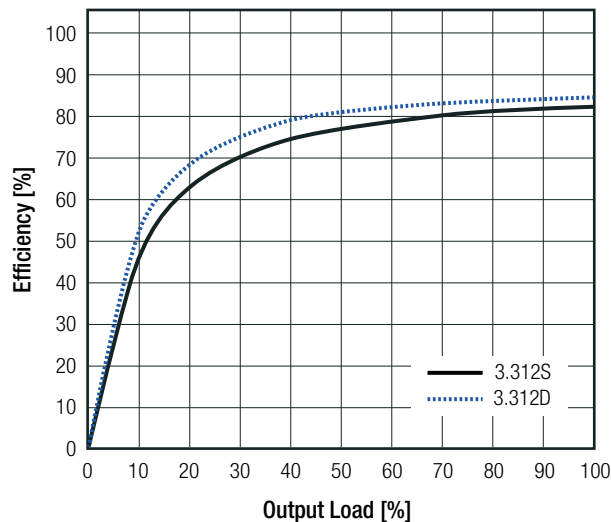

Specifications (measured @ Ta= 25°C, nom. Vin, full load unless otherwise stated)

REGULATIONS			
Parameter	Condition		Value
Output Accuracy			±5.0% max.
Line Regulation	low line to high line, full load		±1.2% typ. @ ±1.0% Vin
Load Regulation ⁽⁴⁾	10% to 100% load	3.3, 5Vout	15.0% max.
		9, 12Vout	10.0% max.
Cross Regulation ⁽⁴⁾	10% to 100% load	dual output only	±5.0% typ.

Notes:

Note4: Operation below 10% load will not harm the converter, but specifications may not be met

Tolerance Envelope

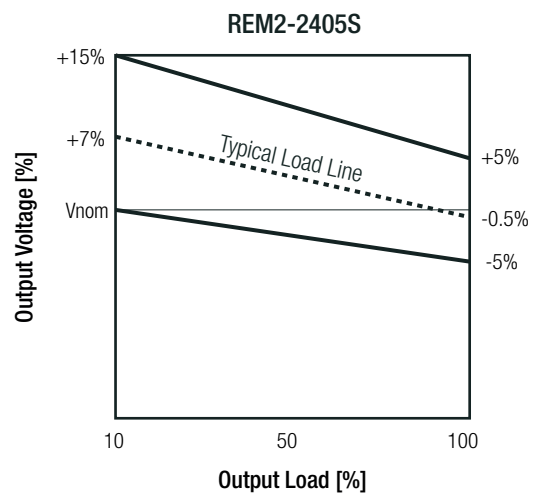
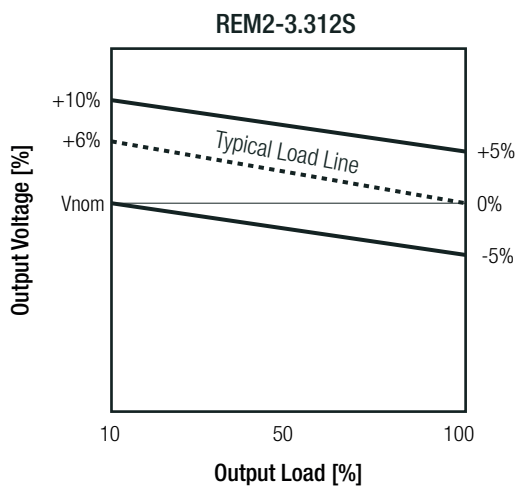

Deviation vs. Load

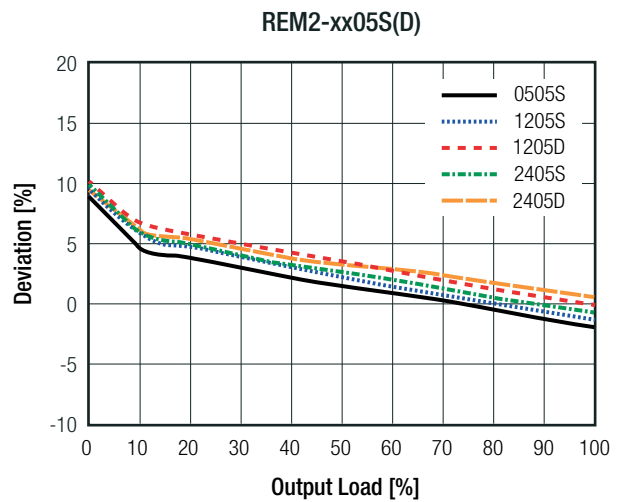
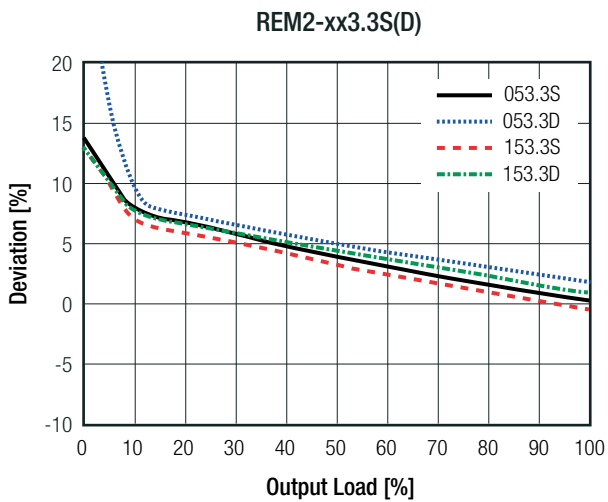

continued on next page

Specifications (measured @ Ta= 25°C, nom. Vin, full load unless otherwise stated)

Deviation vs. Load

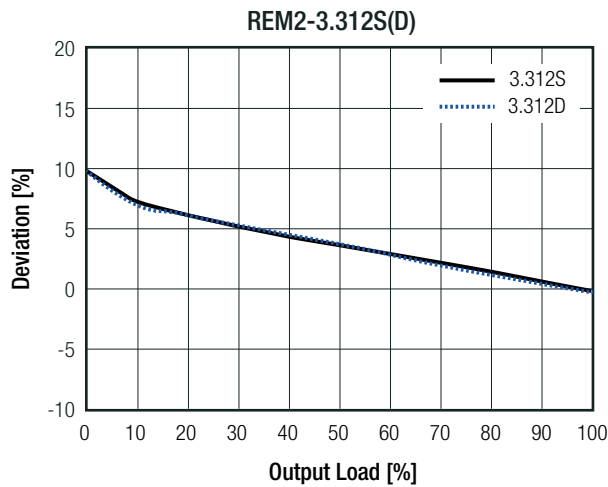

PROTECTIONS

Parameter	Type	Value	
Isolation Voltage ⁽⁶⁾	I/P to O/P	tested for 1 minute	5.2kVDC
		rated for 1 minute	4kVAC
Isolation Resistance		10GΩ min.	
Isolation Capacitance		25pF typ.	
Insulation Grade		reinforced	
Means of Protection	250VAC working voltage	2MOPP	
Medical Device Classification		built-in power supply	
Internal	clearance / creepage	>8.1mm	
External	clearance / creepage	>9.0mm	

Notes:

Note5: For repeat Hi-Pot testing, reduce the time and/or the test voltage

Note6: Refer to local safety regulations if input over-current protection is also required. Recommended fuse: slow blow type

ENVIRONMENTAL

Parameter	Condition	Value	
Operating Temperature Range	full load @ natural convection 0.1m/s (see graph)	-40°C to +80°C	
Maximum Case Temperature		+105°C	
Temperature Coefficient		±0.02%/K	
Thermal Impedance	0.1m/s, horizontal	40K/W	
Operating Altitude		5000m	
Operating Humidity	non-condensing	5% - 95% RH max.	
Pollution Degree		PD2	
Vibration		according to MIL-STD-202G standard	
MTBF	according to MIL-HDBK-217F, G.B.	+25°C	12900 x 10 ³ hours
		+80°C	5300 x 10 ³ hours

continued on next page

Specifications (measured @ Ta= 25°C, nom. Vin, full load unless otherwise stated)

Derating Graph

(@ Chamber and natural convection 0.1 m/s)

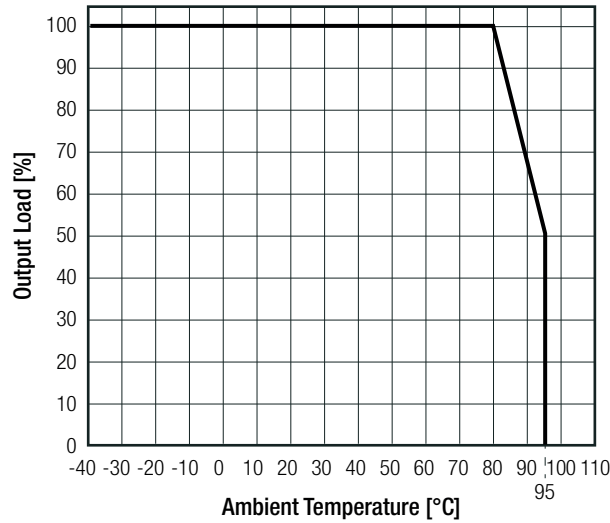

SAFETY AND CERTIFICATIONS

Certificate Type (Safety)	Report / File Number	Standard
Medical Electric Equipment, General Requirements for Safety and Essential Performance	E314885	CAN/CSA-C22.2 No. 60601-1:14, 3rd Edition, 2014 ANSI/AAMI ES60601-1 + A2:2010/®2012
Medical Electric Equipment, General Requirements for Safety and Essential Performance (CB scheme)	CB190124C12 001	IEC60601-1:2005, 3rd Edition + AM1:2012
Medical Electric Equipment, General Requirements for Safety and Essential Performance	WD-SE-R-190048-A0	EN60601-1:2006 + A1:2013
Audio/Video, Information and Communication Technology Equipment - Part1: Safety Requirements	WD-SE-R-180528-B0	IEC62368-1:2014, 2nd Edition EN62368-1:2014 + AC:2015
RoHS2+		RoHS-2011/65/EU + AM-2015/863

EMC Compliance	Condition	Standard / Criterion
Medical Electrical Equipment Part 1-2: Electromagnetic Disturbances – Requirements and Tests	WH-CE-E18083002	EN60601-1-2:2015
Industrial, Scientific and Medical Equipment - Radio Frequency Disturbance Characteristics - Limits and Methods of Measurement		EN55011:2016 + A1:2017, Class B
Information Technology Equipment - Radio Disturbance Characteristics - Limits and Methods of Measurement	with external filter	EN55032, Class B
ESD Electrostatic Discharge Immunity Test	Air ±2, 4, 8, 15kV Contact ±2, 4, 6, 8kV	IEC61000-4-2, Criteria A
Radiated, Radio-Frequency, Electromagnetic Field Immunity Test	10V/m (80-2700MHz) 9, 27, 28V/m (several frequencies)	IEC61000-4-3, Criteria A
Fast Transient and Burst Immunity	DC Power Port: ±0.5, 1, 2kV	IEC61000-4-4, Criteria A
Surge Immunity	DC Power Port: ±0.5, 1kV	IEC61000-4-5, Criteria B
Immunity to Conducted Disturbances, Induced by Radio-Frequency Fields	DC Power Port: 3, 6V	IEC61000-4-6, Criteria A
Power Magnetic Field Immunity	50Hz, 30A/m	IEC61000-4-8, Criteria A

continued on next page

Specifications (measured @ Ta= 25°C, nom. Vin, full load unless otherwise stated)

EMC Filtering Suggestions according to EN55032

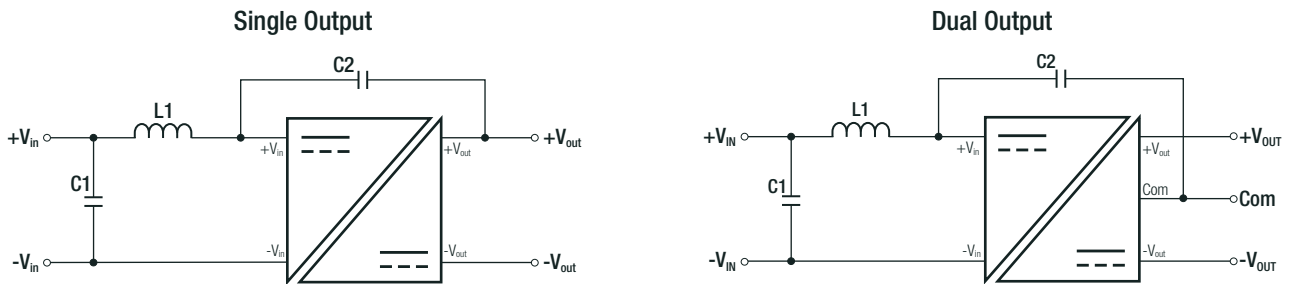

Component List Class B

Input Voltage	C1	C2	L1
3.3VDC	4.7µF	470pF / 6kVDC	47µH
5VDC	10µF		22µH
12VDC	4.7µF		22µH
15VDC	10µF		22µH
24VDC			47µH

DIMENSION AND PHYSICAL CHARACTERISTICS

Parameter	Type	Value
Material	case potting PCB	black plastic, (UL94V-0) silicone, (UL94V-0) FR4, (UL94V-0)
Dimension (LxWxH)		23.0 x 8.0 x 12.2mm
Weight		4.4g typ.

Dimension Drawing (mm)

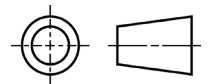
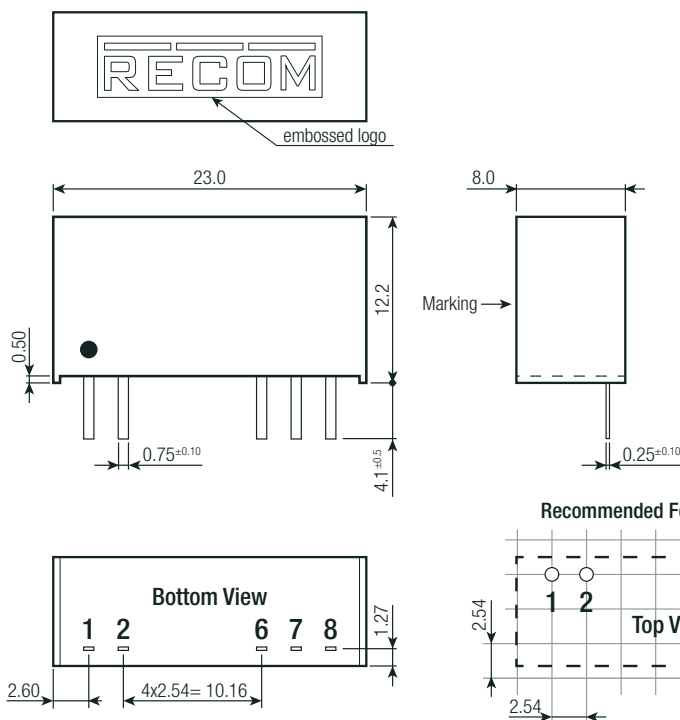

Pinning information

Pin #	Single	Dual
1	+Vin	+Vin
2	-Vin	-Vin
6	-Vout	-Vout
7	+Vout	Com
8	No Pin	+Vout

Tolerance: xx.x= ±0.5mm
xx.xx= ±0.25mm

Recommended Footprint Details

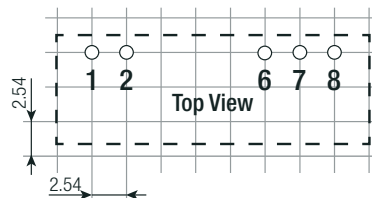

Specifications (measured @ Ta= 25°C, nom. Vin, full load unless otherwise stated)

PACKAGING INFORMATION		
Parameter	Type	Value
Packaging Dimension (LxWxH)	tube	520.0 x 22.1 x 10.2mm
Packaging Quantity	tube	20pcs
Storage Temperature Range		-55°C to +125°C
Storage Humidity	non-condensing	95% RH max.

The product information and specifications may be subject to changes even without prior written notice. The product has been designed for various applications; its suitability lies in the responsibility of each customer. The products are not authorized for use in safety-critical applications without RECOM's explicit written consent. A safety-critical application is an application where a failure may reasonably be expected to endanger or cause loss of life, inflict bodily harm or damage property. The applicant shall indemnify and hold harmless RECOM, its affiliated companies and its representatives against any damage claims in connection with the unauthorized use of RECOM products in such safety-critical applications.