

Features

- Wide input range (4.5 - 18VDC)
- Low profile 2mm
- Small footprint 3x3mm
- Adjustable output 0.6 to 5VDC
- Over 100°C ambient temperature at full load
- Integrated solution

Power Module

RPL-2.0

2.0 Amp 7-Pin QFN Package



Description

The RPL-2.0 is a buck converter with an integrated inductor in a tiny 3mm x 3mm x 2mm thermally-enhanced QFN package. The input range is from 4.5 to 18VDC, allowing 5V and 12V supply rails to be used. The output voltage can be set with two resistors in the range from 0.6V up to 5VDC. The output current is up to 2A and is fully protected against continuous short-circuits, output overcurrent, or over-temperature faults. Its high current and small size as well as its high ambient temperature rating make the RPL-2.0 ideal for imaging systems, distributed power architectures, and portable equipment in telecom as well as in industrial applications where thermal performance is critical.

Selection Guide

Part Number	Input Voltage Range [VDC]	Output Voltage Range [VDC]	Output Current max. [mA]	Efficiency ⁽¹⁾ typ. [%]
RPL-2.0	4.5 - 18	0.6 - 5.0	2000	86

Notes:

Note1: Efficiency tested at V_{IN} = 4.5VDC, full load, and V_{OUT} = 1.2VDC

Model Numbering

RPL-2.0-

Output Current ——— Packaging ⁽²⁾

Notes:

Note2: add suffix "-R" for tape and reel packaging
add suffix "-CT" for cut tape packaging (refer to "**PACKAGING INFORMATION**")

Specifications

ABSOLUTE MAX RATINGS (exceeding these ratings may damage the device)				
Parameter	Symbol	Min.	Typ.	Max.
Absolute Maximum Voltage	V_{IN} to GND	0VDC		19VDC
	V_{BS} to BS	0VDC		4VDC
	others ⁽³⁾	-0.3VDC		19.3VDC
Maximum continuous power losses ⁽⁴⁾	$T_{AMB} = 25^{\circ}C$			1.75W
Junction Temperature	T_J	-40°C		+150°C
Lead Temperature	10 seconds max			+260°C

Notes:

Note3: For CTRL absolute max ratings, please refer to "**CTRL Operating CONDITIONS**"

Note4: Exceeding maximum allowable power dissipation causes device to enter thermal shutdown which protects device from permanent damage. Refer to "**CHARACTERISTIC CURVES**"

Specifications

OPERATING CONDITIONS ($V_{IN}= 12VDC$, $V_{OUT}= 5VDC$, $I_{OUT}= 1A$, unless otherwise noted, typical values are at $T_{AMB}= +25^{\circ}C$)

Parameter	Symbol	Condition	Min.	Typ.	Max.
Input Voltage Range	V_{IN}	refer to "SAFE OPERATING AREA"	4.5VDC		18VDC
Under Voltage Lockout UVLO					4.5VDC
UVLO hysteresis				500mV	
Output Voltage Range	V_{OUT}	refer to "OUTPUT VOLTAGE SETTING"	0.6VDC		5VDC
Output Current Range	I_{OUT}		0A		2A
Standby current	I_{IN}	$V_{CTRL} = 0VDC$		5 μ A	10 μ A
Quiescent current	I_Q	$V_{FB} = V_{REF} \times 105\%$		180 μ A	
Switching frequency	f_{SW}			1MHz	
Feedback voltage	V_{FB}		594mV	600mV	606mV
Output load regulation					refer to "Characteristic Curves"
Minimum On Time				50ns	
Minimum Off Time		V_{OUT} from 10% to 90%		150ns	
Soft Start				1.4ms	

Typical Application

$V_{IN}= 12VDC$, $V_{OUT}= 5VDC$, $I_{OUT}= 2A$

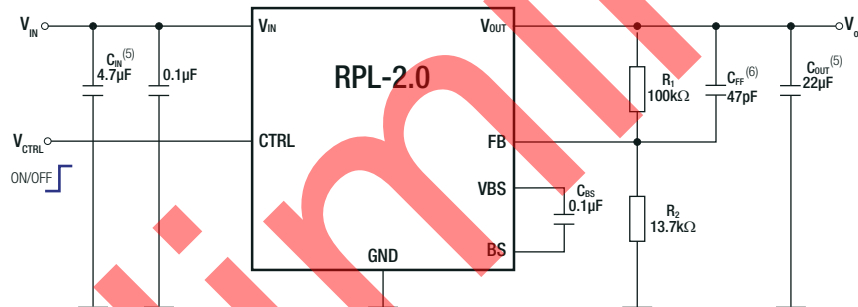

Notes:

Note5: The RPL-2.0 requires a 4.7 μ F MLCC input capacitor as close as possible to V_{IN} and GND pin and a 22 μ F output capacitor to reduce noise.

Note6: Transient load reaction time can be improved by adding a feed-forward capacitor, C_{FF} across V_{OUT} and FB pin, but it is not required for normal operation.

SAFE OPERATING AREA

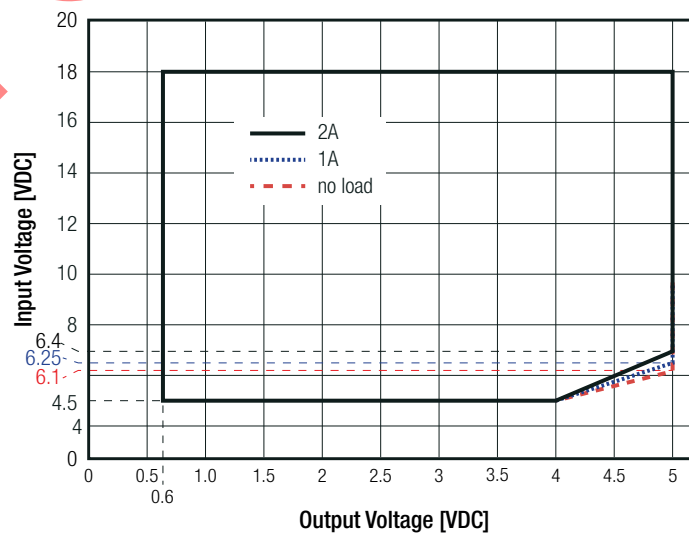

Specifications

OUTPUT VOLTAGE SETTING

A resistor divider connected to the FB pin (pin 2) sets the output voltage of the RPL-2.0. The output voltage adjustment range is from 0.6VDC to 5VDC. The schematic below shows the feedback resistor connections for setting the output voltage. The recommended value of R1 is 100kΩ. Use the equation to calculate the value for R2. The table below lists the R2 resistor values according to standard E96 values; therefore, the specified voltage may slightly vary.

Feedback Network

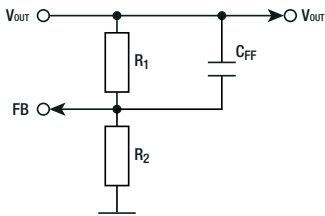

Calculation:

$$R_2 = \frac{0.6V}{(V_{OUTset} - 0.6V)} \times R_1$$

Practical example with $V_{OUTset} = 1.8VDC$

$$R_2 = \frac{0.6V}{(1.8V - 0.6V)} \times 100k\Omega = 50k\Omega$$

Table below lists recommended resistor values for common V_{OUT} :

V_{OUTset} [VDC]	R1 [Ω]	R2 [Ω]	C_{FF} [pF]	C_{OUT} [μF]
1.2	100k	100k	optional *	22
1.5		66k5		22
1.8		49k9		22
2.5		31k6		22
3.3		22k1		22
5		13k7		22

*to stabilize the system and optimize the load transient response, place a feed-forward capacitor (C_{FF}) in parallel with R1.

CTRL OPERATING CONDITIONS ($V_{IN} = 12VDC$, $V_{OUT} = 5VDC$, $I_{OUT} = 1A$, unless otherwise noted, typical values are at $T_{AMB} = +25^\circ C$)

Parameter	Symbol	Condition	Min.	Typ.	Max.
CTRL rising threshold	V_{CTRL_RISING}		1.5VDC		
CTRL falling threshold	$V_{CTRL_FALLING}$				0.4VDC

PROTECTIONS

Parameter	Condition	Value
Short Circuit Protection SCP		current limit fold-back mode
Thermal shutdown	junction temperature	150°C typ.
	hysteresis	15°C

THERMAL OPERATING CONDITIONS ($V_{IN} = 12VDC$, $V_{OUT} = 5VDC$, $I_{OUT} = 1A$, unless otherwise noted, typical values are at $T_{AMB} = +25^\circ C$)

Parameter	Symbol	Condition	Min.	Typ.	Max.
Operating Ambient Temperature	T_{AMB}	junction to ambient	refer to "Thermal Derating"		
Operating Junction Temperature	T_J		-40°C		+125°C
Thermal Resistance ⁽⁷⁾	R_{th_JA}	junction to ambient		40K/W	
	R_{th_JC}	junction to case		4K/W	

Notes:

Note7: Tested with 60x60mm, double layer PCB (75μm copper) RECOM EVM board.

ENVIRONMENTAL

Parameter	Condition	Value
ESD	human-body model (HBM), ANSI/ESDA/JEDEC JS-001	±2.5kV
	charged-device model (CDM), JEDEC JESD22-C101	±1kV
MTTF	$T_J = 55^\circ C$; VCC max; CL = 60%	13120 x 10 ³ hours

Specifications

TYPICAL PERFORMANCE CHARACTERISTICS ($V_{OUT}= 1.2VDC, T_J= +25^{\circ}C$; tested with RECOM evaluation module: RPL-2.0-EVM-1)

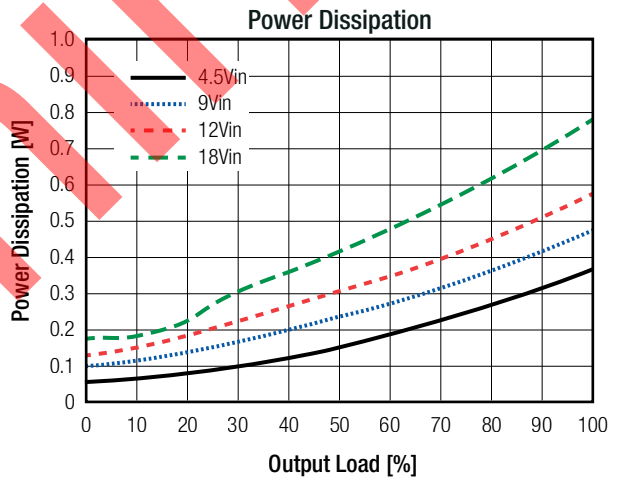
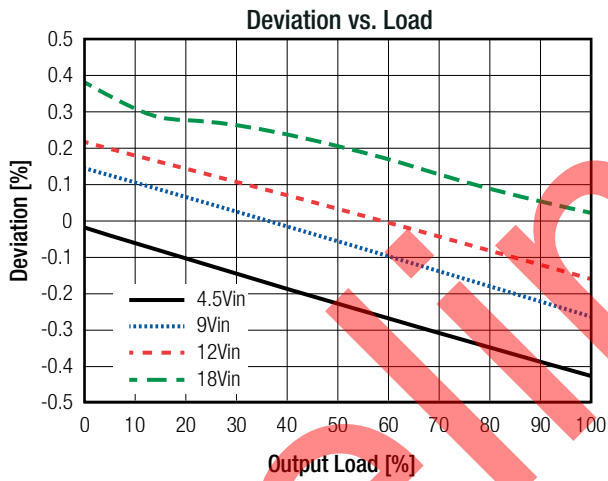
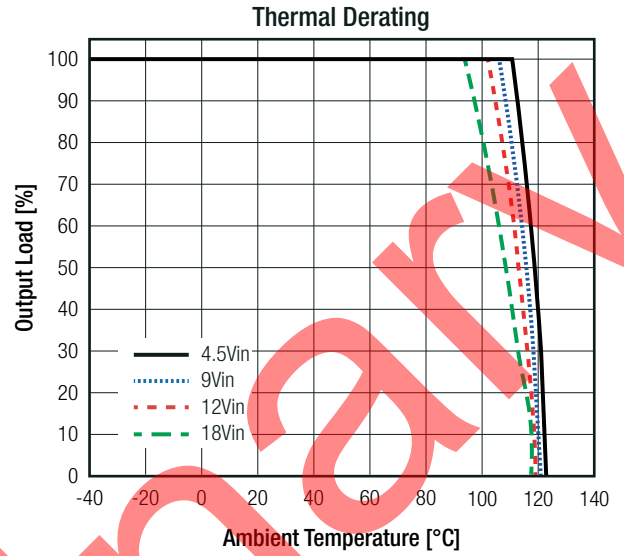
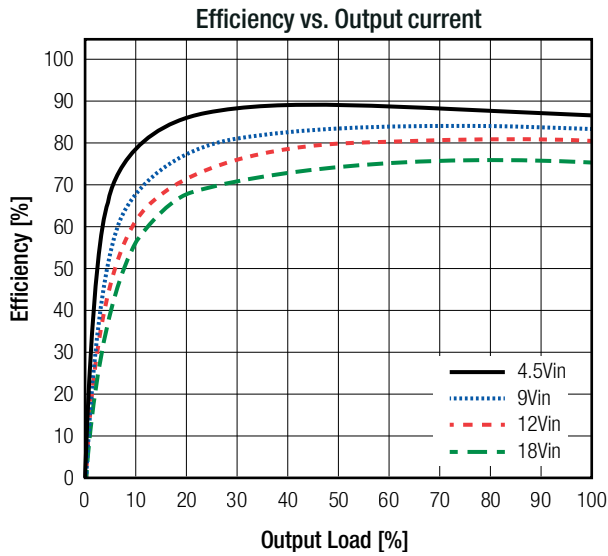

TYPICAL PERFORMANCE CHARACTERISTICS ($V_{OUT}= 3.3VDC, T_J= +25^{\circ}C$; tested with RECOM evaluation module: RPL-2.0-EVM-1)

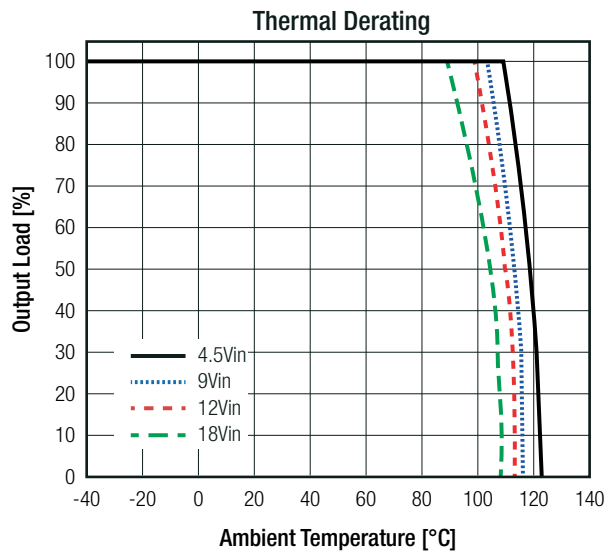
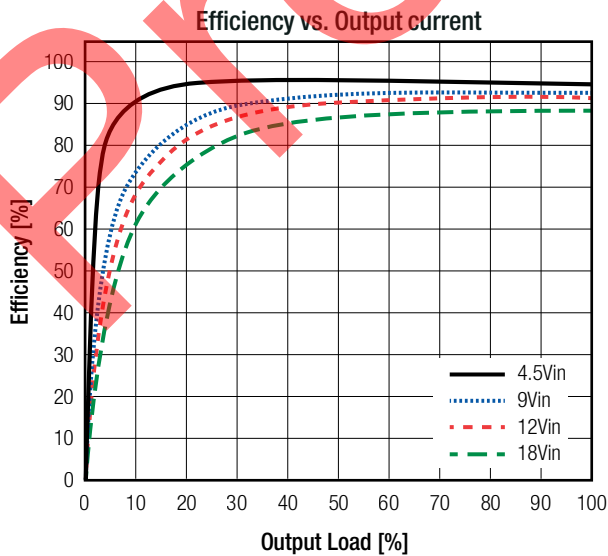

continued on next page

Specifications

TYPICAL PERFORMANCE CHARACTERISTICS ($V_{OUT} = 3.3VDC$, $T_J = +25^\circ C$; tested with RECOM evaluation module: RPL-2.0-EVM-1)

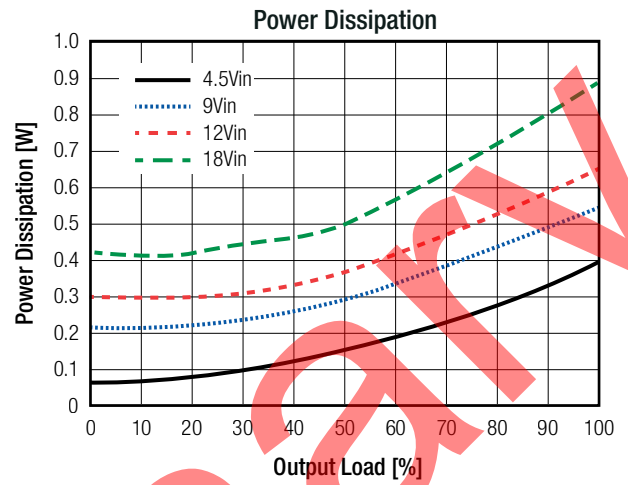
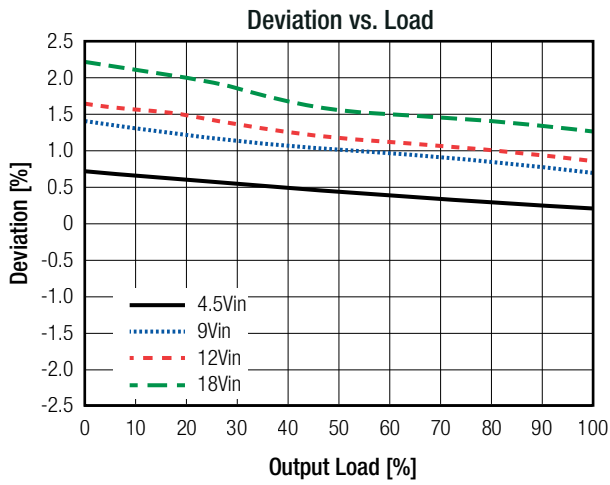

TYPICAL PERFORMANCE CHARACTERISTICS ($V_{OUT} = 5.0VDC$, $T_J = +25^\circ C$; tested with RECOM evaluation module: RPL-2.0-EVM-1)

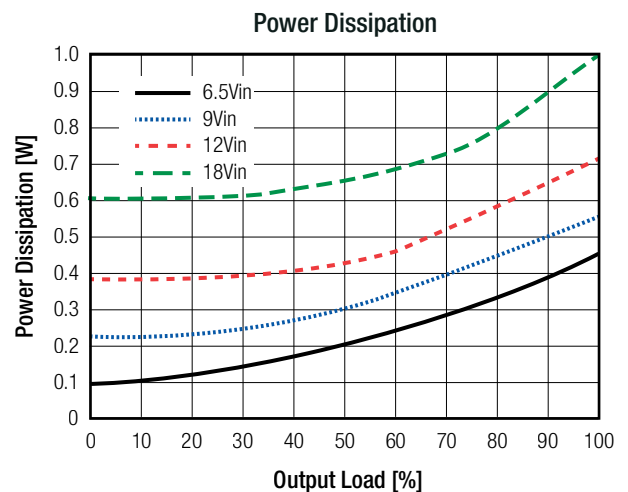
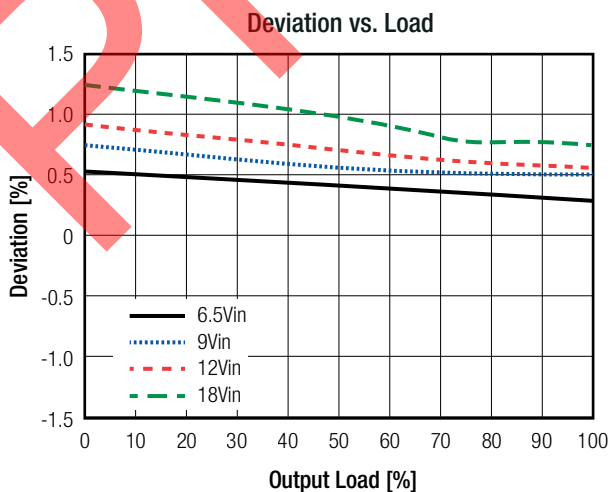
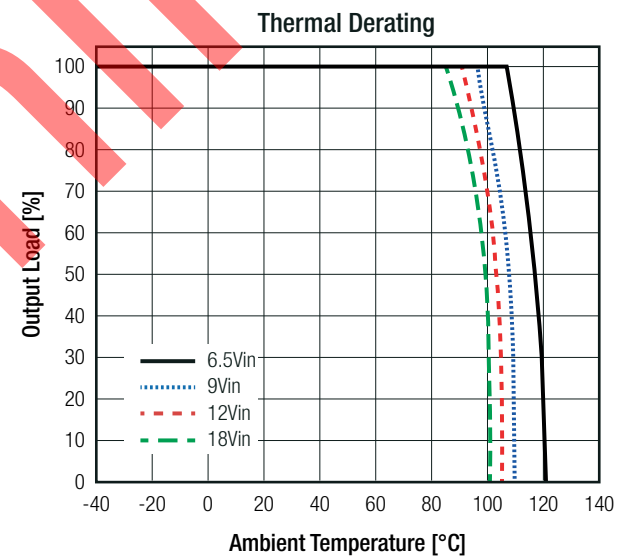

Specifications

SAFETY AND CERTIFICATIONS

Certificate Type (Safety)	Standard
RoHS2	RoHS 2011/65/EU + AM2015/863

DIMENSION AND PHYSICAL CHARACTERISTICS

Parameter	Type	Value
Dimension (LxWxH)		3.0 x 3.0 x 2.0mm
Weight		0.1g typ.

Dimension Drawing (mm)

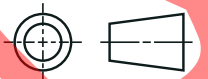
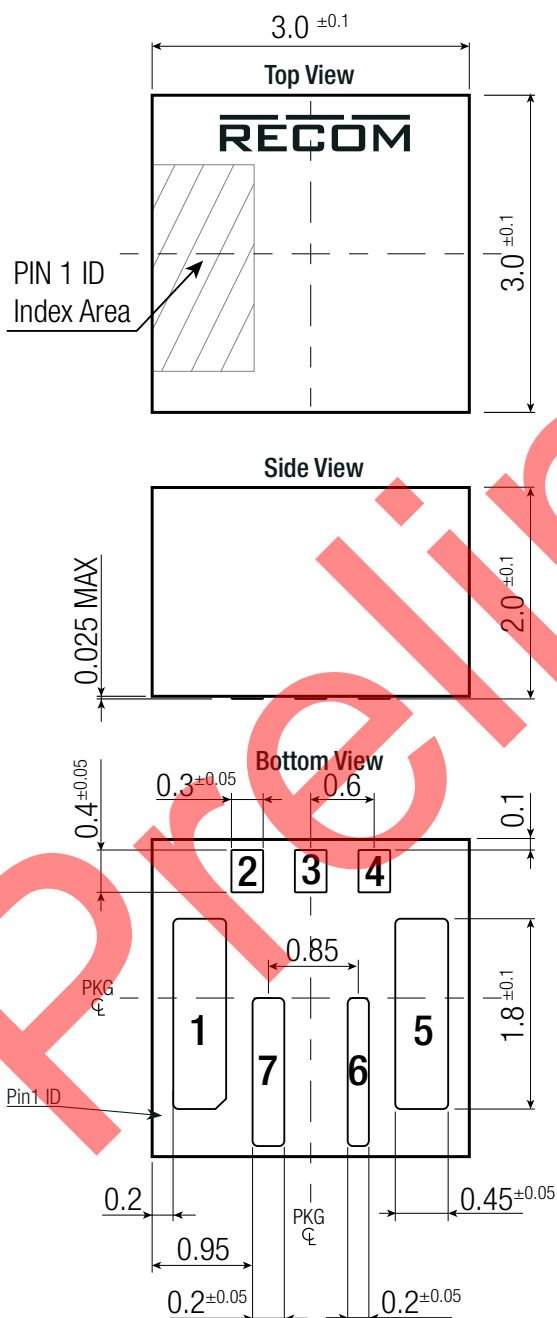

Pad Information

Pad #	Function	Description
1	V _{OUT}	Output voltage pin. Decouple this pin to GND with at least a 22µF MLCC (refer to "Typical Application")
2	FB	Feedback voltage pin. Connect to the center point of output resistor divider to set the output voltage. (refer to "OUTPUT VOLTAGE SETTING")
3	CTRL	Pull high to turn on. Don not leave floating.
4	V _{BS}	Voltage boot-strap pin. Supply high side gate driver. Decouple this pin to BS pin with 0.1µF ceramic capacitor
5	BS	Boot-strap pin. Connect to V _{BS}
6	V _{IN}	Input voltage pin. Decouple to GND with at least a 4.7µF ceramic capacitor
7	GND	GND pin

All dimensions exclude mold flash and metal burr.

Tolerances:
x.x= ±0.1mm
x.xx= ±0.05mm

**Recommended Footprint Details (*)
(Top View)**

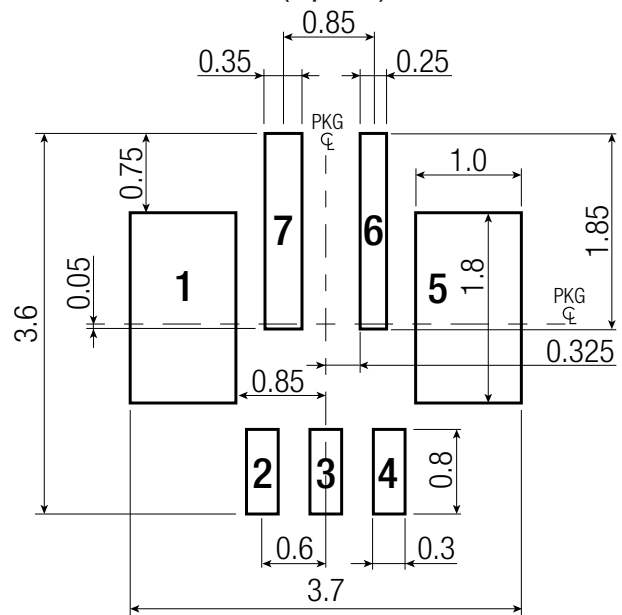

A large ground plane greatly reduces noise and increases thermal performance.

Specifications

SOLDERING

Profile Feature	PB-Free Assembly
Preheat	
minimum Temperature (TS_min)	150°C
maximum Temperature (TS_max)	200°C
Time (tS)	60s-120s
Liquids	
Temperature (TL)	217°C
Time (tL)	60-150s
Peak Temperature (TP)	
Peak Temperature (TP)	255°C
max Ramp Down Rate (from Ts_max to TP)	6°C/s
max Ramp Up Rate	3°C/s
max time from 25°C to Peak Temperature (TP)	8min

- 1 Pb-Free assembly is recommended according to JEDEC J-STD020.
- 2 Ensure that the peak re-flow temperature does not exceed 240°C ±5°C as per JEDEC J-STD020
- 3 The re-flow time period during peak temperature of 240°C ±5°C should not exceed 30 seconds.
- 4 Re-flow time above liquids (217°C) should not exceed 150 seconds.
- 5 For solder paste use a standard SAC Alloy such as SAC 305, type 3 or higher.
- 6 Other soldering methods (e.g. vapor-phase) are not verified and have to be validated at his own risk.

Solder Pofil

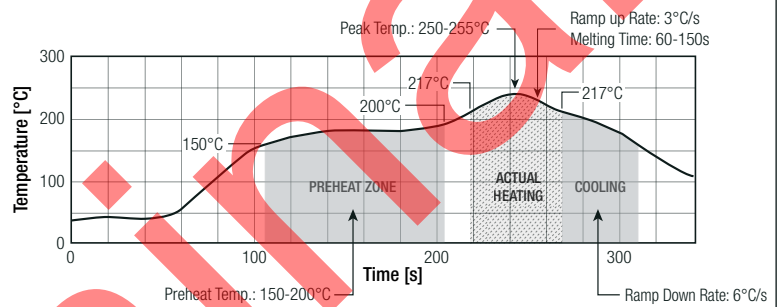

BLOCK DIAGRAM

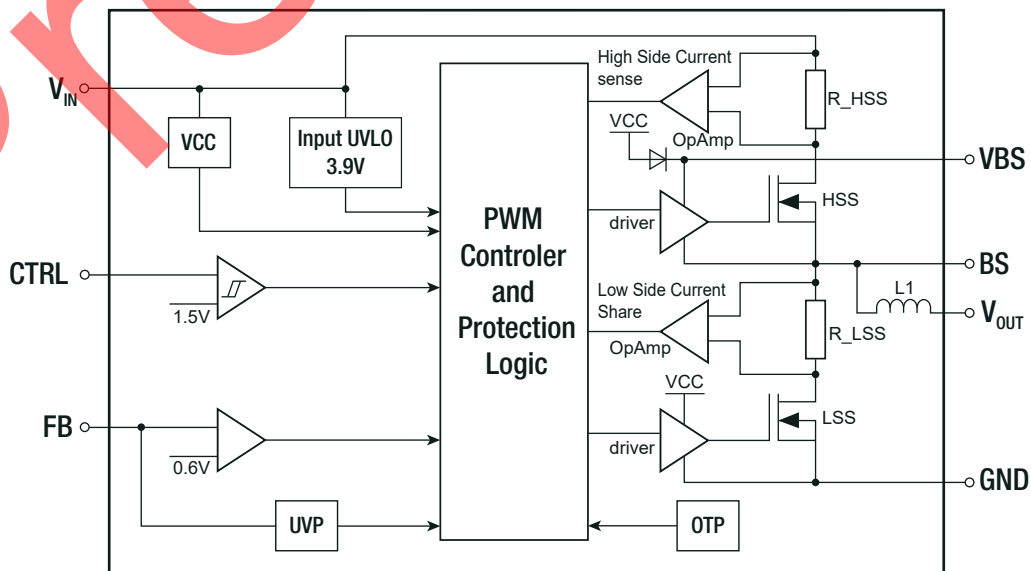

Specifications

PACKAGING INFORMATION		
Parameter	Type	Value
Packaging Dimension (LxWxH)	reel 13" (diameter + width)	Ø330.2 + 12.4mm
	tape and reel (carton)	355.0 x 340.0 x 39.0mm
	moisture barrier bag ("-CT")	100.0 x 100.0 x 30.0mm
Packaging Quantity	tape and reel	3000pcs
	moisture barrier bag ("-CT")	50pcs
Tape Width		12mm
Storage Temperature Range		-65°C to +150°C
Moisture Sensitive Level	MSL peak temp. ⁽⁹⁾	Level 3, 260°C, 168hrs
Notes: Note9: The Moisture Sensitivity Level rating is according to the JEDEC industry standard classifications and peak solder temperature		

Preliminary

The product information and specifications may be subject to changes even without prior written notice. The product has been designed for various applications; its suitability lies in the responsibility of each customer. The products are not authorized for use in safety-critical applications without RECOM's explicit written consent. A safety-critical application is an application where a failure may reasonably be expected to endanger or cause loss of life, inflict bodily harm or damage property. The applicant shall indemnify and hold harmless RECOM, its affiliated companies and its representatives against any damage claims in connection with the unauthorized use of RECOM products in such safety-critical applications.