

# RPL-20 Series / Power Module

## 20A / 4-16VDC / 29 Pad LGA-M Package

### FEATURES

- High power density (7 x 7 x 4.4mm)
- Operating temperature of -40°C to +90°C at full load
- High efficiency 94%
- Wide 4-16VDC input voltage
- SCP, OCP, and UVLO protection
- Programmable 0.6 - 5.5V output
- Selectable pulse-skip and CCM modes
- 3 year warranty



Dimensions (LxWxH): 7.0 x 7.0 x 4.4mm (0.276 x 0.276 x 0.173inch)  
0.1g (0.0002 lbs)

### APPLICATIONS



### SAFETY & EMC



### DESCRIPTION

The RPL-20 is a 20A buck converter with integrated inductor in a compact 7mm x 7mm x 4.4mm thermally-enhanced LGA package. The input range is from 4.0 to 16VDC, allowing both 5V and 12V supply rails to be used. The output voltage can be set with two resistors in the range from 0.6V up to 5.5V. The output is fully protected against continuous short-circuit, overload, under-voltage or over-temperature faults. A PG output and EN input allow easy power sequencing. Its high output current capability, small size, light load pulse skipping and fast transient regulation make the RPL-20 ideal for FPGAs, imaging systems, distributed power architectures, portable equipment in telecom as well as industrial applications.

### SELECTION GUIDE

Part Number	Input Voltage Range [VDC]	Output Voltage Range [VDC]	Output Current max. [A]	Efficiency <sup>(1)</sup> typ. [%]
RPL-20	4 - 16	0.6 - 5.5	20	94

Note1: Efficiency is tested at  $V_{IN}= 12VDC$ ,  $V_{OUT}= 5VDC$  full load at +25°C ambient

### MODEL NUMBERING

**RPL-20-**  
 Output Current \_\_\_\_\_ Packaging <sup>(2)</sup>

Note2: Add suffix "-CT" for bag packaging (refer to „Packaging Information“)

# RPL-20 Series / Power Module

## 20A / 4-16VDC / 29 Pad LGA-M Package

### ABSOLUTE MAXIMUM RATINGS

Parameter	Symbol	Condition	Min.	Typ.	Max.
Absolute Maximum Voltage	$V_{IN}$		-0.3VDC		18VDC
	$V_{SW}$		-0.3VDC		0.3VDC
	$V_{CC}$				4.5VDC
	others		-0.3VDC		4.3VDC
Maximum Continuous Power Losses <sup>(3)</sup>		$T_{AMB} = +25^{\circ}C$			9.25W
Junction Temperature	$T_J$				+170°C
Lead Temperature					+260°C

Note3: Exceeding maximum allowable power dissipation causes device to enter thermal shutdown which protects device from permanent damage.

Note4: Stressed beyond those listed under absolute maximum ratings can cause permanent damage to the device.

### BASIC CHARACTERISTICS (measured @ $T_{AMB} = 25^{\circ}C$ , nom. $V_{IN}$ , full load and after warm-up unless otherwise stated)

Parameter	Symbol	Condition	Min.	Typ.	Max.
Input voltage range	$V_{IN}$	refer to „Safe Operating Area“	4VDC		16VDC
Vin-Vsw			-0.3VDC		0.3VDC
Vsw			-0.3VDC		0.3VDC
Under Voltage Lockout UVLO		rising, $V_{CC} = 3.3VDC$	2.1VDC	2.4VDC	2.7VDC
		falling, $V_{CC} = 3.3VDC$	1.55VDC	1.85VDC	2.15VDC
Under Voltage Lockout Treshold		% of Vref	77%	80%	83%
Quiescent Current	$I_Q$	$V_{CTRL} = 2VDC, V_{FB} = 0.62VDC$		650µA	850µA
Output Voltage Range	$V_{OUT}$	refer to „Output Voltage Setting“	0.6VDC		5.5VDC
Standby Current	$I_S$			0µA	10µA
High Side RDS (on)		$V_{CTRL} = 0VDC$		8.6mΩ	
Low Side RDS (on)		$V_{CTRL} = 2VDC$		2.5mΩ	
Minimum On Time		$V_{FB} = 500mV$			65ns
Minimum Off Time		$V_{FB} = 500mV$			190ns

### Typical Application

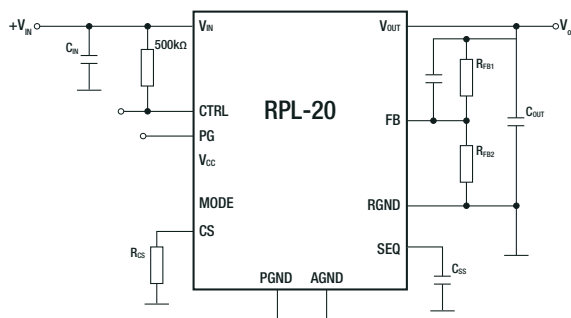

### Safe Operating Area

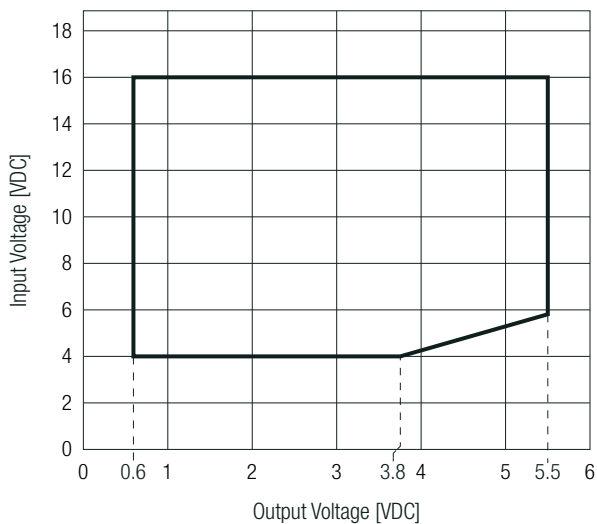

### CTRL OPERATING CONDITIONS

Parameter	Symbol	Condition	Min.	Typ.	Max.
ON/OFF CTRL		DC-DC ON			$V_{CTRL} > 1.22VDC$
		DC-DC OFF			$V_{CTRL} < 1.20VDC$
CTRL Voltage				3.6VDC	
CTRL Rising Threshold	$V_{CTRL\_RISING}$		1.19VDC	1.22VDC	1.25VDC
CTRL Hysteresis Threshold			160mV	200mV	280mV
CTRL Input Current	$I_{CTRL}$	$V_{CTRL} = 2VDC$		0μA	

### POWER GOOD OPERATING CONDITIONS

Parameter	Symbol	Condition	Min.	Typ.	Max.
High Threshold	$PG_{HIGH\_RISE}$	Pull FB from low to high	89.5% of $V_{REF}$	92.5% of $V_{REF}$	95.5% of $V_{REF}$
	$PG_{HIGH\_FALL}$	Pull FB from high to low	92% of $V_{REF}$	101% of $V_{REF}$	108% of $V_{REF}$
Low Threshold	$PG_{LOW\_RISE}$	Pull FB from low to high	113% of $V_{REF}$	116% of $V_{REF}$	119% of $V_{REF}$
	$PG_{LOW\_FALL}$	Pull FB from high to low	77% of $V_{REF}$	80% of $V_{REF}$	83% of $V_{REF}$
Rise Delay		$T_J = 25^\circ C$	0.63ms	0.9ms	1ms
Sink Current Capability	$V_{PG}$	$I_{PG} = 10mA$			0.5VDC
Leakage Current	$I_{PG\_LEAK}$	$V_{PG} = 3.3VDC$			3μA
Low Output Voltage	$V_{OUT\_LOW\_100}$	$V_{IN} = 0VDC$ , pull PG to 3.3VDC with 100kΩ resistor		650mV	800mV
	$V_{OUT\_LOW\_10}$	$V_{IN} = 0VDC$ , pull PG to 3.3VDC with 10kΩ resistor		750mV	900mV

### SWITCHING CHARACTERISTICS

Parameter	Symbol	Condition	Min.	Typ.	Max.
Switching Frequency	$f_{sw}$	mode= GND, $I_{OUT} = 0A$ , $V_{OUT} = 1VDC$ , $T_J = 25^\circ C$	480kHz	600kHz	720kHz
		mode= 34.8kΩ, $I_{OUT} = 0A$ , $V_{OUT} = 1VDC$ , $T_J = 25^\circ C$	680kHz	800kHz	920kHz
		mode= 80.6kΩ, $I_{OUT} = 0A$ , $V_{OUT} = 1VDC$ , $T_J = 25^\circ C$	850kHz	1000kHz	1150kHz

### VCC CONDITIONS

Parameter	Symbol	Condition	Min.	Typ.	Max.
VCC Regulator			2.88VDC	3VDC	3.12VDC
VCC Load Regulation		$I_{CC} = 25mA$		0.5%	
VCC UVLO Rising Threshold			2.65VDC	2.81VDC	2.95VDC
VCC UVLO Falling Threshold			2.35VDC	2.5VDC	2.65VDC
External VCC bias			3.12VDC		3.6VDC

### OUTPUT VOLTAGE SETTING

The RPL-20 series offers the feature of trimming the output voltage by using external trim resistor. To optimize the load transient response, it is recommended to place a feed-forward capacitor ( $C_{FF}$ ) in parallel with  $R_{FB1}$ . The values for trim resistors shown in trim tables below are according to standard E96 values; therefore, the specified voltage may slightly vary.

#### Feedback Network

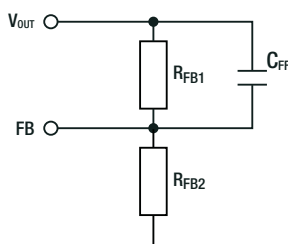

#### Calculation:

$$R_{FB2} = \frac{V_{ref}}{(V_{OUT} - V_{ref})} \times R_{FB1}$$

#### Practical example with $V_{OUT} = 1.8VDC$

$$R_{FB2} = \frac{0.6V}{(1.8V - 0.6V)} \times 4k\Omega = 2k\Omega$$

Table below lists recommended resistor values for common  $V_{OUT}$ :

$V_{OUTset}$ [VDC]	$C_{FF}$ [F]	$R_{FB1}$ [Ω]	$R_{FB2}$ [Ω]
0.8	1n	4k0	12k1
1.2			4k0
1.8		2k0	
2.5	68p	6k3	1k4
3.3		9k1	
5.0		10k2	1k4
5.5			1k2

# RPL-20 Series / Power Module

## 20A / 4-16VDC / 29 Pad LGA-M Package

### THERMAL OPERATING CONDITIONS

Parameter	Symbol	Condition	Min.	Typ.	Max.
Operating Junction Temperature	$T_J$	refer to „Thermal Derating“	-40°C		+125°C
Thermal Resistance <sup>(5)</sup>	$R_{th,JA}$	junction to ambient		16.2K/W	
	$R_{th,JC}$	junction to case		5.1K/W	
	$R_{th,JB}$	junction to board		7.7K/W	

Note5: Test PCB= 6.4 x 6.4cm double sided PCB with 20oz copper, natural convection

### ENVIRONMENTAL

Parameter	Condition	Value
Electrostatic Discharge	Human body model (HBM)	±2kV typ.
	Charged device model (CDM)	±2kV typ.
Moisture Sensitive Level		Level 3, 245°C, 168hrs

### PROTECTIONS

Parameter	Condition	Value	
Over Current Protection (OCP)		hiccup, auto recovery	
Output Overvoltage Protection Rising	% of $V_{REF}$	113% min. - 119% max.	
Thermal Shutdown	restart after cooldown	junction temperature	160°C typ.
		hysteresis	30°C typ.

### TYPICAL PERFORMANCE CHARACTERISTICS

#### 3.3Vout

Efficiency vs. Output Current

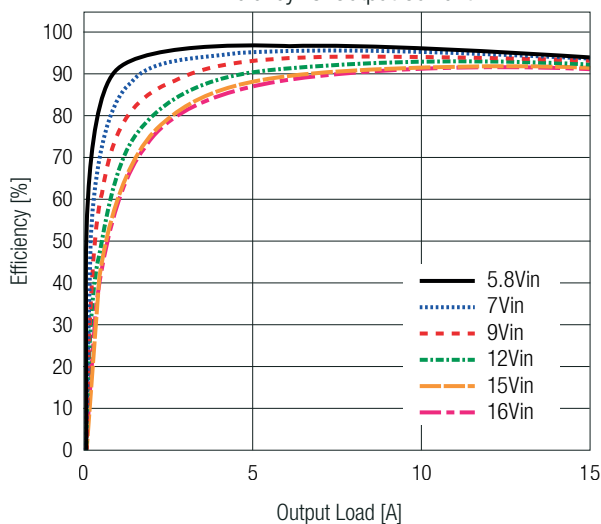

Thermal Derating

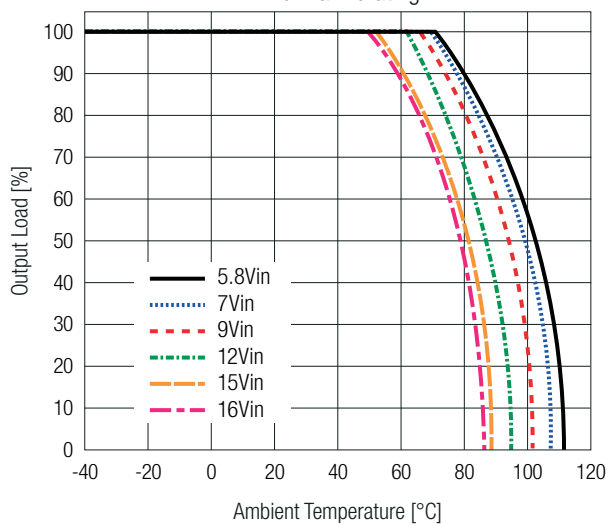

Deviation vs. Load

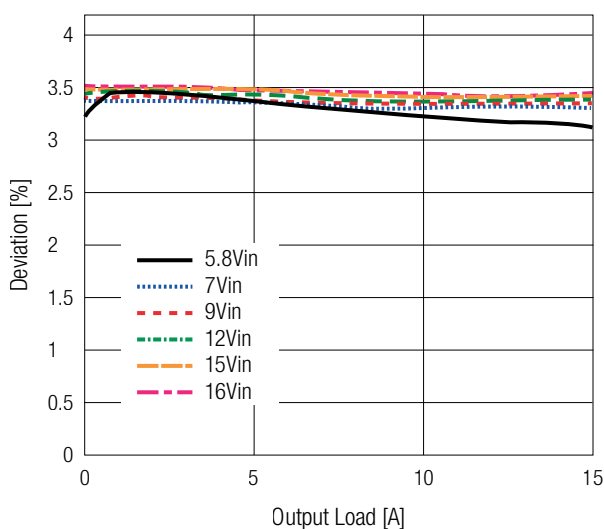

Power Dissipation

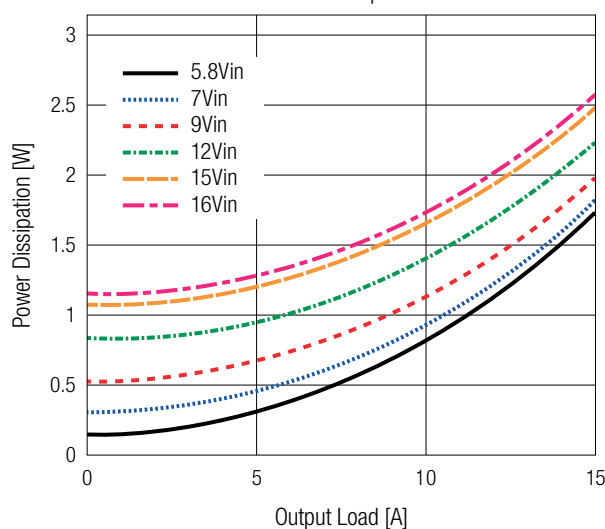

### TYPICAL PERFORMANCE CHARACTERISTICS

#### 5.5Vout

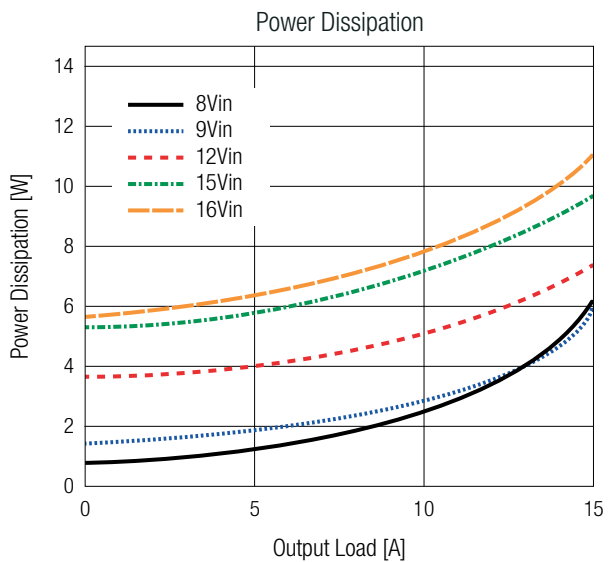
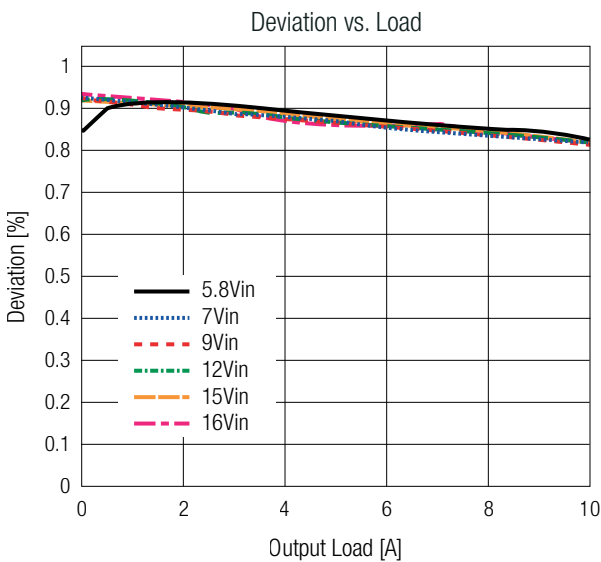
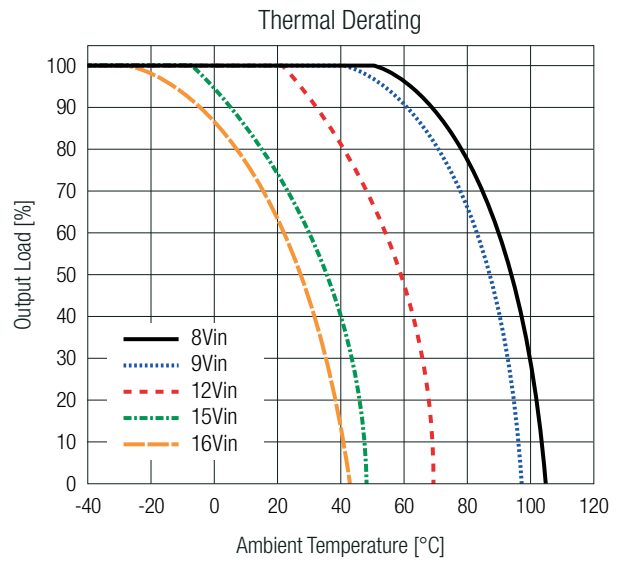
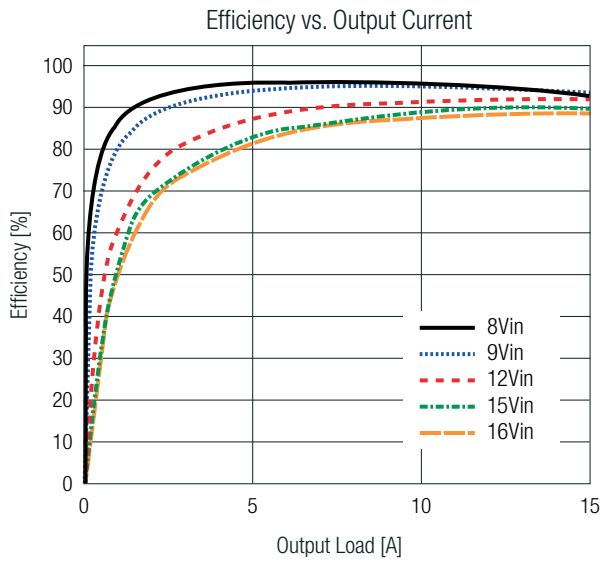

### SAFETY & CERTIFICATIONS

Certificate Type (Safety)	Report Number	Standard
RoHS2		RoHS 2011/65EU + AM2015/863

### DIMENSION & PHYSICAL CHARACTERISTICS

Parameter	Type	Value
Material	case	plastic
Dimension (LxWxH)		7.0 x 7.0 x 4.4mm 0.276 x 0.276 x 0.173inch
Weight		0.1g typ. 0.0002lbs

### DIMENSION & PHYSICAL CHARACTERISTICS

Dimension Drawing (mm)

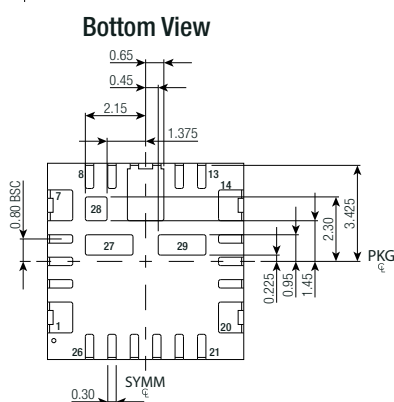
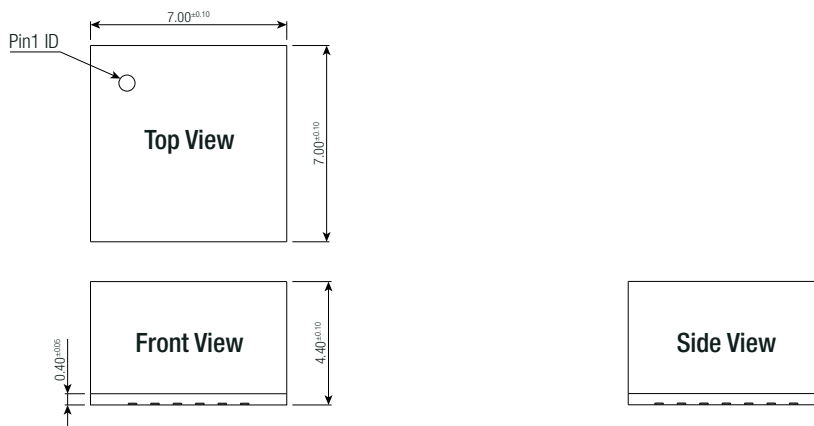
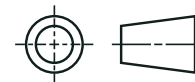

Recommended Footprint Details (Top View)

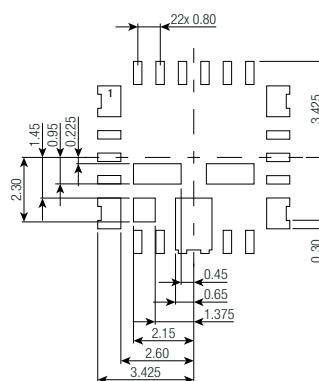

Tolerances:  
 x.x= ±0.1mm  
 x.xx= ±0.05mm

### Pad Information

Pad #	Function	Description
1, 2, 6, 7	V <sub>OUT</sub>	Output Voltage
3	CTRL/UVLO	CTRL pin. Do not float.
4	PG	Power good output.
5, 8, 9, 27, 28	+V <sub>IN</sub>	Input supply voltage. Connect using wide PCB traces.
10, 11, 12	PGND	System ground. Use wide PCB traces.
13	V <sub>CC</sub>	Internal 3V low-dropout (LDO) output.
14, 15, 16, 19, 20, 29	SW	Connect to floating copper plane for improved thermal performance. Thermal pad must be floating.
17	NC	Do not connect.
18, 21	AGND	Analog ground. AGND pin is the control circuit reference point.
22	CS	Current limit setpoint.
23	MODE	Operation mode selection. Configure the MODE pin to the operating switching frequency (f <sub>sw</sub> ).
24	SEQ	External tracking voltage/soft start capacitor input. V <sub>OUT</sub> tracks the SEQ pin input signal. In the range of 0.6-1.4V. Decouple with 27nF MLCC capacitor between this pin and Sense, or use a larger value to increase the soft-start time.
25	Sense	Connect to negative voltage sense point or to AGND if not used.
26	FB	FB input. Used to set output voltage between 0.6 and 5.5V.

# RPL-20 Series / Power Module

20A / 4-16VDC / 29 Pad LGA-M Package



## PACKAGING INFORMATION

Parameter	Type	Value
Packaging Dimension (LxWxH)	Suffix -CT: moisture barrier bag	152 x 102 x 30mm
Packaging Quantity		20pcs
Storage Temperature Range		-65°C to +150°C
Storage Humidity	non-condensing	60% RH max.

The product information and specifications may be subject to changes even without prior written notice. The product has been designed for various applications; its suitability lies in the responsibility of each customer. The products are not authorized for use in safety-critical applications without RECOM's explicit written consent. A safety-critical application is an application where a failure may reasonably be expected to endanger or cause loss of life, inflict bodily harm or damage property. The applicant shall indemnify and hold harmless RECOM, its affiliated companies and its representatives against any damage claims in connection with the unauthorized use of RECOM products in such safety-critical applications.