

2A, 200V - 1000V Fast Recovery Surface Mount Rectifier

FEATURES

- Glass passivated chip junction
- Low power loss, high efficiency
- Fast switching for high efficiency
- Low profile package
- Moisture sensitivity level: level 1, per J-STD-020
- RoHS Compliant
- Halogen-free according to IEC 61249-2-21

APPLICATIONS

- DC to DC converter
- Switching mode converters and inverters
- General purpose

MECHANICAL DATA

- Case: SOD-128
- Molding compound meets UL 94V-0 flammability rating
- Terminal: Matte tin plated leads, solderable per J-STD-002
- Meet JESD 201 class 2 whisker test
- Polarity: Indicated by cathode band
- Weight: 0.027g (approximately)

| KEY PARAMETERS | | |
|----------------|------------|------|
| PARAMETER | VALUE | UNIT |
| I_F | 2 | A |
| V_{RRM} | 200 - 1000 | V |
| I_{FSM} | 50 | A |
| T_{JMAX} | 150 | °C |
| Package | SOD-128 | |
| Configuration | Single die | |



SOD-128



| ABSOLUTE MAXIMUM RATINGS ($T_A = 25^\circ\text{C}$ unless otherwise noted) | | | | | | | | |
|--|--------------------|-------------|--------|--------|--------|--------|------|---|
| PARAMETER | SYMBOL | RS2DFS | RS2GFS | RS2JFS | RS2KFS | RS2MFS | UNIT | |
| Marking code on the device | | RS2DFS | RS2GFS | RS2JFS | RS2KFS | RS2MFS | | |
| Repetitive peak reverse voltage | V_{RRM} | 200 | 400 | 600 | 800 | 1000 | V | |
| Reverse voltage, total rms value | $V_{R(RMS)}$ | 140 | 280 | 420 | 560 | 700 | V | |
| Forward current | I_F | 2 | | | | | A | |
| Surge peak forward current, single half sine-wave superimposed on rated load | $t = 8.3\text{ms}$ | I_{FSM} | | | | | 50 | A |
| | $t = 1.0\text{ms}$ | | | | | | 140 | A |
| Junction temperature | T_J | -55 to +150 | | | | | °C | |
| Storage temperature | T_{STG} | -55 to +150 | | | | | °C | |

THERMAL PERFORMANCE

| PARAMETER | SYMBOL | TYP | UNIT |
|--|-----------------|-----|------|
| Junction-to-lead thermal resistance | $R_{\theta JL}$ | 16 | °C/W |
| Junction-to-ambient thermal resistance | $R_{\theta JA}$ | 73 | °C/W |
| Junction-to-case thermal resistance | $R_{\theta JC}$ | 14 | °C/W |

Thermal Performance Note: Units mounted on PCB (5mm x 5mm Cu pad test board)

ELECTRICAL SPECIFICATIONS ($T_A = 25^\circ\text{C}$ unless otherwise noted)

| PARAMETER | CONDITIONS | SYMBOL | TYP | MAX | UNIT | |
|--|----------------------------|---|--|------|---------------|----|
| Forward voltage ⁽¹⁾ | RS2DFS RS2GFS | V_F | $I_F = 1.0\text{A}, T_J = 25^\circ\text{C}$ | 0.93 | - | V |
| | | | $I_F = 2.0\text{A}, T_J = 25^\circ\text{C}$ | 1.01 | 1.30 | V |
| | RS2JFS | | $I_F = 1.0\text{A}, T_J = 125^\circ\text{C}$ | 0.78 | - | V |
| | | | $I_F = 2.0\text{A}, T_J = 125^\circ\text{C}$ | 0.88 | 1.02 | V |
| | RS2KFS RS2MFS | | $I_F = 1.0\text{A}, T_J = 25^\circ\text{C}$ | 0.98 | - | V |
| | | | $I_F = 2.0\text{A}, T_J = 25^\circ\text{C}$ | 1.06 | 1.30 | V |
| | | | $I_F = 1.0\text{A}, T_J = 125^\circ\text{C}$ | 0.83 | - | V |
| | | | $I_F = 2.0\text{A}, T_J = 125^\circ\text{C}$ | 0.93 | 1.05 | V |
| Reverse current @ rated V_R ⁽²⁾ | $T_J = 25^\circ\text{C}$ | I_R | - | 1 | μA | |
| | $T_J = 125^\circ\text{C}$ | | - | 40 | μA | |
| Reverse recovery time | RS2DFS RS2GFS | $I_F = 0.5\text{A}, I_R = 1.0\text{A}, I_{rr} = 0.25\text{A}$ | t_{rr} | - | 150 | ns |
| | RS2JFS | | | - | 250 | ns |
| | RS2KFS RS2MFS | | | - | 500 | ns |
| Junction capacitance | RS2DFS RS2GFS RS2JFS | 1MHz, $V_R = 4.0\text{V}$ | C_J | 11 | - | pF |
| | RS2KFS RS2MFS | | | 10 | - | pF |

Notes:

1. Pulse test with PW = 0.3ms
2. Pulse test with PW = 30ms

ORDERING INFORMATION

| ORDERING CODE ⁽¹⁾ | PACKAGE | PACKING |
|------------------------------|---------|----------------------|
| RS2xFS | SOD-128 | 14,000 / Tape & Reel |

Notes:

1. "x" defines voltage from 200V(RS2DFS) to 1000V(RS2MFS)

CHARACTERISTICS CURVES

($T_A = 25^\circ\text{C}$ unless otherwise noted)

Fig.1 Forward Current Derating Curve

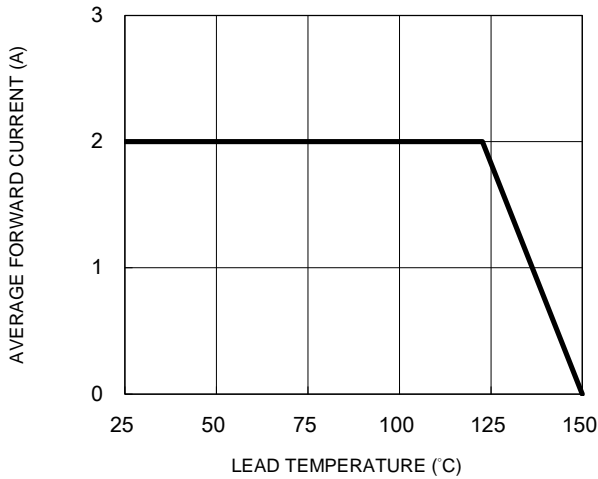

Fig.2 Typical Junction Capacitance

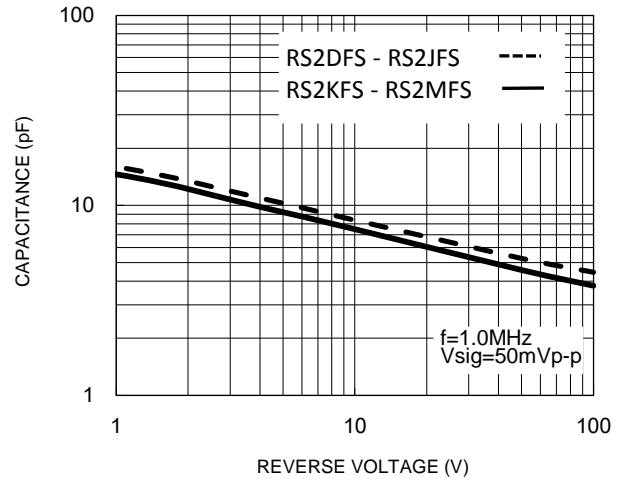

Fig.3 Typical Reverse Characteristics

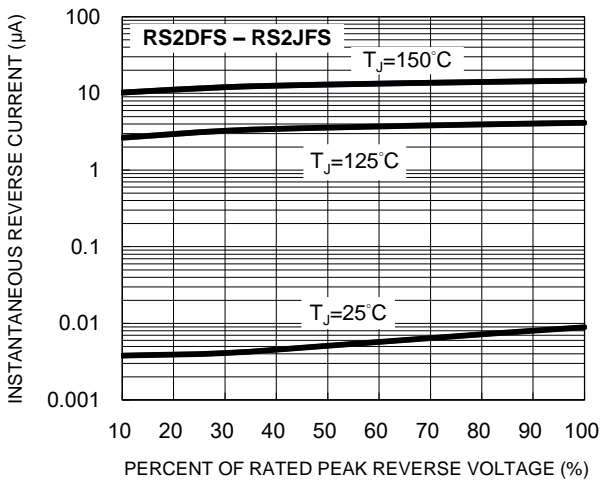

Fig.4 Typical Forward Characteristics

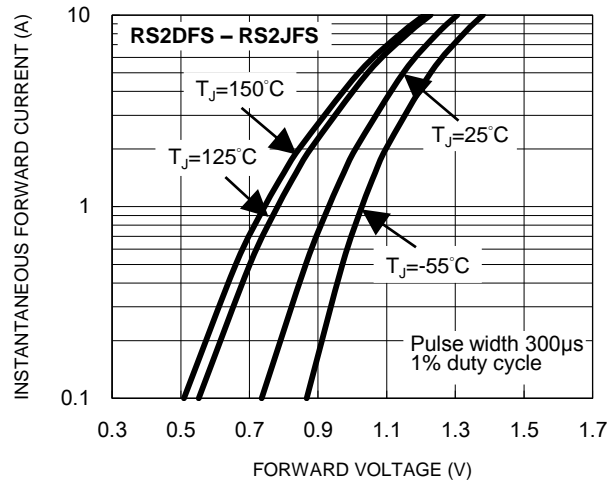

Fig.5 Typical Reverse Characteristics

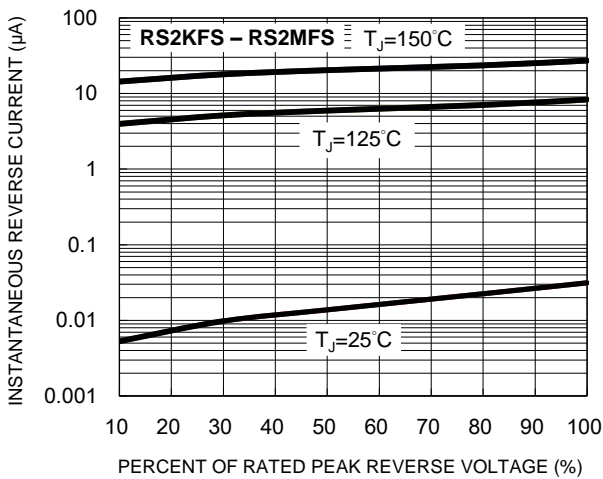
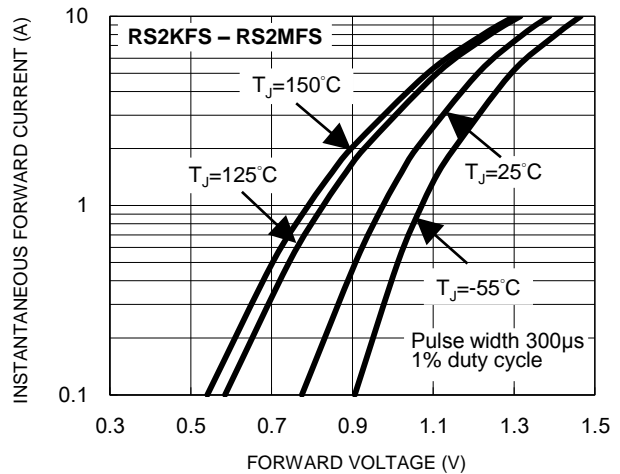

Fig.6 Typical Forward Characteristics



CHARACTERISTICS CURVES

($T_A = 25^\circ\text{C}$ unless otherwise noted)

Fig.7 Typical Transient Thermal Impedance

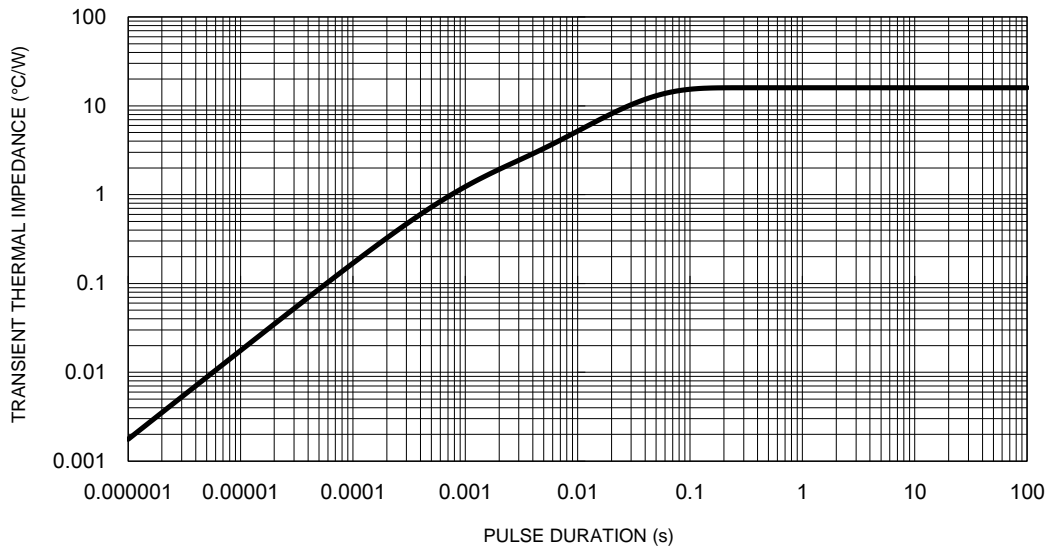

PACKAGE OUTLINE DIMENSIONS

SOD-128

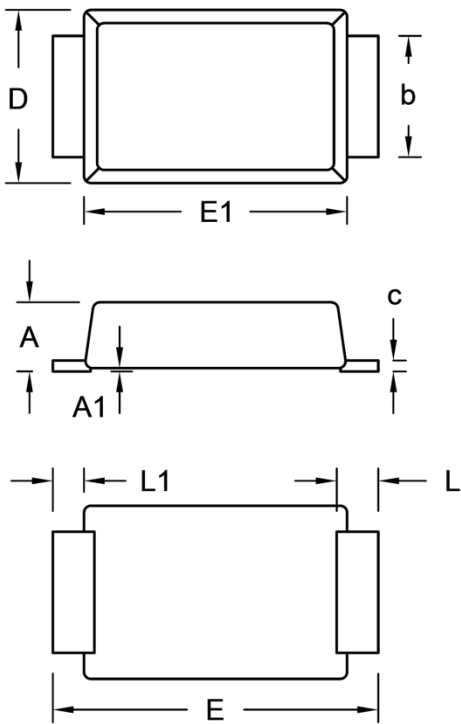

| DIM. | Unit (mm) | | Unit (inch) | |
|------|-----------|------|-------------|-------|
| | Min. | Max. | Min. | Max. |
| A | 0.90 | 1.10 | 0.035 | 0.043 |
| A1 | 0.00 | 0.10 | 0.000 | 0.004 |
| b | 1.60 | 1.90 | 0.063 | 0.075 |
| c | 0.10 | 0.22 | 0.004 | 0.009 |
| D | 2.30 | 2.70 | 0.091 | 0.106 |
| E | 4.40 | 5.00 | 0.173 | 0.197 |
| E1 | 3.60 | 4.00 | 0.142 | 0.157 |
| L | 0.40 | 0.80 | 0.016 | 0.031 |
| L1 | 0.30 | 0.60 | 0.012 | 0.024 |

SUGGESTED PAD LAYOUT

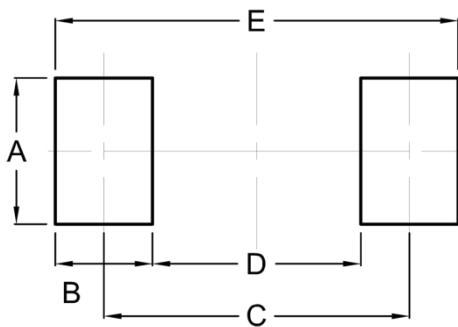

| Symbol | Unit (mm) | Unit (inch) |
|--------|-----------|-------------|
| A | 2.10 | 0.083 |
| B | 1.40 | 0.055 |
| C | 4.40 | 0.173 |
| D | 3.00 | 0.118 |
| E | 5.80 | 0.228 |

MARKING DIAGRAM



P/N = Marking Code
 YW = Date Code
 F = Factory Code

Notice

Specifications of the products displayed herein are subject to change without notice. TSC or anyone on its behalf, assumes no responsibility or liability for any errors or inaccuracies.

Purchasers are solely responsible for the choice, selection, and use of TSC products and TSC assumes no liability for application assistance or the design of Purchasers' products.

Information contained herein is intended to provide a product description only. No license, express or implied, to any intellectual property rights is granted by this document. Except as provided in TSC's terms and conditions of sale for such products, TSC assumes no liability whatsoever, and disclaims any express or implied warranty, relating to sale and/or use of TSC products including liability or warranties relating to fitness for a particular purpose, merchantability, or infringement of any patent, copyright, or other intellectual property right.

The products shown herein are not designed for use in medical, life-saving, or life-sustaining applications. Customers using or selling these products for use in such applications do so at their own risk and agree to fully indemnify TSC for any damages resulting from such improper use or sale.