

Crystal Oscillator (SPXO)

- Package size (3.2 mm × 2.5 mm × 1.05 mm)
- Fundamental mode SPXO
- Output: HCSL
- Reference weight Typ.26 mg

[1] Product Number / Product Name / Marking

(1-1) Product Number / Ordering Code

X1G0051410004xx

Last 2 digits code(**xx**) defines Quantity.

The standard is "00", 2 000 pcs/Reel.

(1-2) Product Name / Model Name

SG3225HBN 100.000000MHz CJGA

[2] Operating Range

Parameter	Symbol	Specifications			Unit	Conditions
		Min.	Typ.	Max.		
Supply voltage	V _{CC}	3.135	3.3	3.465	V	-
	GND	0	-	0	V	-
Operating temperature range	T _{use}	-40	-	85	°C	-
HCSL load condition	L _{HCSL}	-	50	-	Ω	-
	R _S	-	33	-	Ω	-

[3] Frequency Characteristics

(Unless stated otherwise [2] Operating Range)

Parameter	Symbol	Specifications			Unit	Conditions
		Min.	Typ.	Max.		
Output frequency	f _o	-	100.000000	-	MHz	-
Frequency tolerance *1	f _{tol}	-50	-	+50	×10 ⁻⁶	T _{use}

*1 Frequency tolerance includes Initial frequency tolerance, Frequency / temperature characteristics, Frequency / voltage coefficient, and aging (10 years, +25 °C).

[4] Electrical Characteristics

(Unless stated otherwise [2] Operating Range)

Parameter	Symbol	Specifications			Unit	Conditions
		Min.	Typ.	Max.		
Start-up time	t _{str}	-	-	10	ms	t = 0 at 90 % V _{CC}
Current consumption	I _{CC}	-	25	35	mA	OE = V _{CC} , with HCSL load condition
Disable current	I _{dis}	-	-	15	mA	OE = GND
Output voltage	V _{OH}	0.66	-	0.85	V	DC characteristics
	V _{OL}	-0.15	-	0.15	V	DC characteristics
Differential swing	V _{SW}	0.3	-	-	V	-
Crossing voltage	V _{CR}	0.25	-	0.55	V	-
Differential output rise slew rate	R _r	1	-	4	V/ns	Between -0.15 V and 0.15 V of differential output
Differential output fall slew rate	R _f	1	-	4	V/ns	Between -0.15 V and 0.15 V of differential output
Symmetry	SYM	45	50	55	%	At output crossing point
Input voltage	V _{IH}	70 % V _{CC}	-	-	V	OE Terminal
	V _{IL}	-	-	30 % V _{CC}	V	OE Terminal
Output disable time (OE)	t _{stp_oe}	-	-	100	ns	OE terminal HIGH → LOW
Output enable time (OE)	t _{sta_oe}	-	-	100	ns	OE terminal LOW → HIGH

[For other general specifications, please refer to the attached Full Data Sheet below]

Low Jitter Crystal Oscillator: SG3225HBN

Features

- HCSL Output, Low Jitter SPXO
- Phase Jitter: 180 fs Max.
fo = 100 MHz, 12 kHz to 20 MHz RMS
- Frequency range: 100 MHz to 325 MHz
- Supply Voltage Options: 2.5 V Typ. / 3.3 V Typ.
- Frequency Tolerance Options: $\pm 50 \times 10^{-6}$, $\pm 100 \times 10^{-6}$
- Operating Temperature Options:
-40 °C to +85 °C and -40 °C to +105 °C

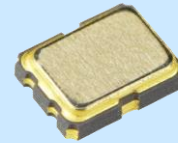

(3.2 × 2.5 × 1.05 mm)

Applications

- Server
- NIC, HBA
- PCI Express® serial communications
- Various high-speed serial communications

Description

SG3225HBN is a low jitter, HCSL output crystal oscillator.

This product is excellent as a PCI Express® reference clock meeting PCIe® 1.0 to PCIe® 5.0 jitter requirements

Outline Drawing

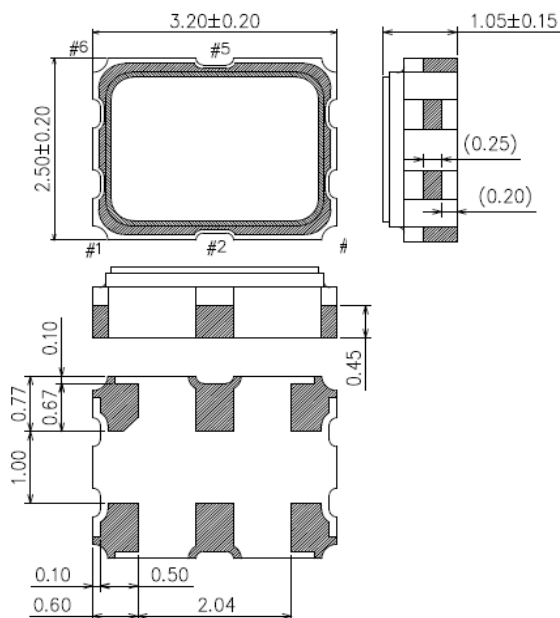

Typical Performance

Conform to PCIe® Jitter Requirement*

[Units: ps]

SG3225HBN	Gen3 limit	Gen4 limit	Gen5 limit
0.04	1.0	0.5	0.15

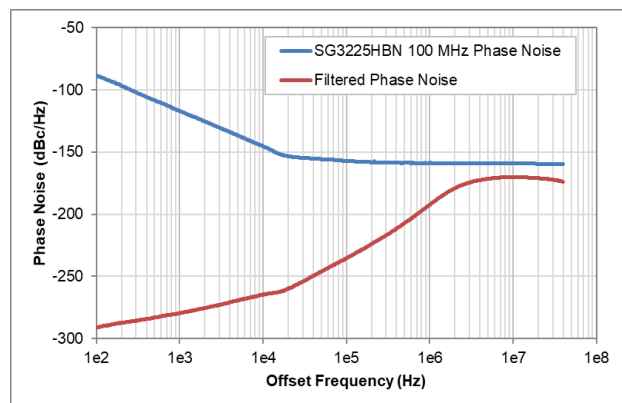

* PCI Express® Base Specification Revision 5.0
8.6.6 Common Refclk Rx Architecture (CC)
8.6.7 Jitter Limits for Refclk Architectures

Terminal Assignment

Pin #	Connection	Function	
#1	OE	OE terminal / active high	
		OE function	Output
		"H" or OPEN	Specified frequency is output: Enable
		"L"	Output becomes high impedance: Disable
#2	NC	—	
#3	GND	GND terminal	
#4	OUT	Output terminal (Positive)	
#5	$\overline{\text{OUT}}$	Output terminal (Negative)	
#6	V _{CC}	V _{CC} terminal	

* PCI Express and PCIe are a registered trademark of PCI-SIG

[1] Product Number / Product Name

(1-1) Product Number

X1G005141xxxx00 (Please contact Epson for details)

(1-2) Product Name (Standard Form)

SG3225 H BN 156.250000MHz C J G A (⑤⑥: Unavailable code JH)

① ② ③ ④ ⑤ ⑥ ⑦

① Model ② Output(H: HCSL) ③ Frequency ④ Supply voltage

⑤ Frequency tolerance ⑥ Operating temperature ⑦ Internal identification code("A" is default)

④ Supply voltage	
D	2.5 V Typ.
C	3.3 V Typ.

⑤ Frequency tolerance	
J	$\pm 50 \times 10^{-6}$
L	$\pm 100 \times 10^{-6}$

⑥ Operating temperature	
G	-40 °C to +85 °C
H	-40 °C to +105 °C

[2] Absolute Maximum Ratings

Parameter	Symbol	Specification			Unit	Conditions
		Min.	Typ.	Max.		
Maximum supply voltage	V_{CC}	-0.5	-	4	V	-
Input voltage	V_{in}	-0.3	-	$V_{CC} + 0.3$	V	OE terminal
Storage temperature range	T_{stg}	-55	-	125	°C	

[3] Operating Range

Parameter	Symbol	Specification			Unit	Conditions
		Min.	Typ.	Max.		
Supply voltage	V_{CC}	2.375	2.5	2.625	V	Suffix: D
		3.135	3.3	3.465	V	Suffix: C
Supply voltage	GND	0.0	0.0	0.0	V	
Operating temperature range	T_{use}	-40	+25	+85	°C	Suffix: G
		-40	+25	+105	°C	Suffix: H
HCSL load condition	L_{HCSL}	50			Ω	

* Power supply startup time (0 % V_{CC} →90 % V_{CC}) should be more than 150 μ s* A 0.1 μ F and a 10 μ F bypass capacitor should be connected between V_{CC} and GND pins located close to the device

[4] Frequency Characteristics

(Unless stated otherwise [3] Operating Range)

Parameter	Symbol	Specification			Unit	Conditions
		Min.	Typ.	Max.		
Output frequency *1	f_o	100	-	325	MHz	
Frequency tolerance *2	f_{tol}	-50	-	+50	$\times 10^{-6}$	Suffix: J T_{use} : G
		-100	-	+100	$\times 10^{-6}$	Suffix: L T_{use} : G or H

*1 Please contact Epson for available frequencies

*2 Frequency tolerance includes initial frequency tolerance, temperature variation, supply voltage change and 10 years aging at +25 °C

[5] Electrical Characteristics

(Unless stated otherwise [3] Operating Range)

Parameter	Symbol	Specification			Unit	Conditions
		Min.	Typ.	Max.		
Startup time	t_str	-	-	10	ms	t = 0 at 90 %V _{CC}
Current consumption	I _{CC}	-	25	35	mA	
Disable current	I _{dis}	-	-	15	mA	OE = GND
Differential output rise slew rate	R _r	1	-	4	V/ns	Between -0.15 V and 0.15 V of differential output
Differential output fall slew rate	R _f	1	-	4	V/ns	
Symmetry	SYM	45	50	55	%	At output crossing point
Output voltage	V _{OH}	0.66	-	0.85	V	DC characteristics, fo ≤ 200 MHz
		0.57	-	0.77	V	DC characteristics, fo > 200 MHz
	V _{OL}	-0.15	-	0.15	V	DC characteristics
Differential swing	V _{SW}	0.3	-	-	V	
Crossing voltage	V _{CR}	0.25	-	0.55	V	
Crossing voltage variation	V _{DCR}	-	-	0.14	V	
Input voltage	V _{IH}	70 % V _{CC}	-	-	V	OE terminal
	V _{IL}	-	-	30 % V _{CC}	V	
Output disable time (OE)	tstp_oe	-	-	100	ns	100 MHz ≤ fo ≤ 200 MHz
		-	-	200	ns	200 MHz < fo ≤ 325 MHz
Output enable time (OE)	tsta_oe	-	-	100	ns	100 MHz ≤ fo ≤ 200 MHz
		-	-	200	ns	200 MHz < fo ≤ 325 MHz
Phase jitter (12 kHz to 20 MHz)	t _{PJ}	-	-	180	fs	fo=100 MHz
		-	-	160	fs	fo=125 MHz
		-	-	140	fs	fo=156.25 MHz
		-	-	125	fs	fo=200 MHz
		-	-	110	fs	fo=322.265625 MHz

[6] Thermal resistance (For reference only)

Parameter	Symbol	Specification			Unit	Conditions
		Min.	Typ.	Max.		
Junction temperature	T _j	-	-	125	°C	
Junction to case	θ _{jc}	-	97.9	-	°C/W	
Junction to ambient	θ _{ja}	-	155.4	-	°C/W	

[7] Typical Performance Characteristics (For reference only)

The following data shows typical performance characteristics

(7-1) Frequency / Temperature Characteristics

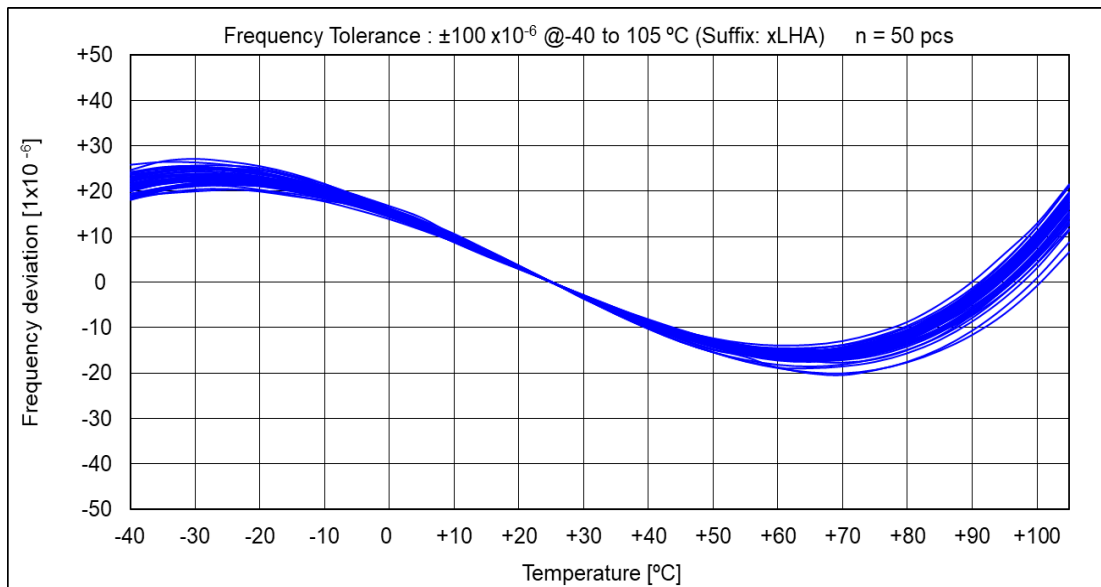
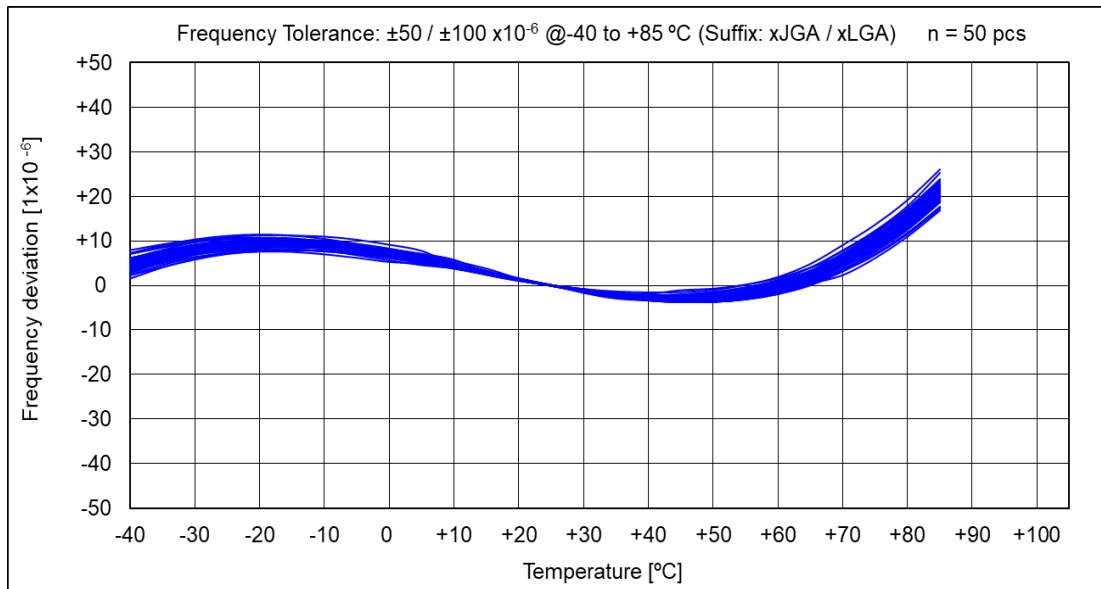

(7-2) Current Consumption

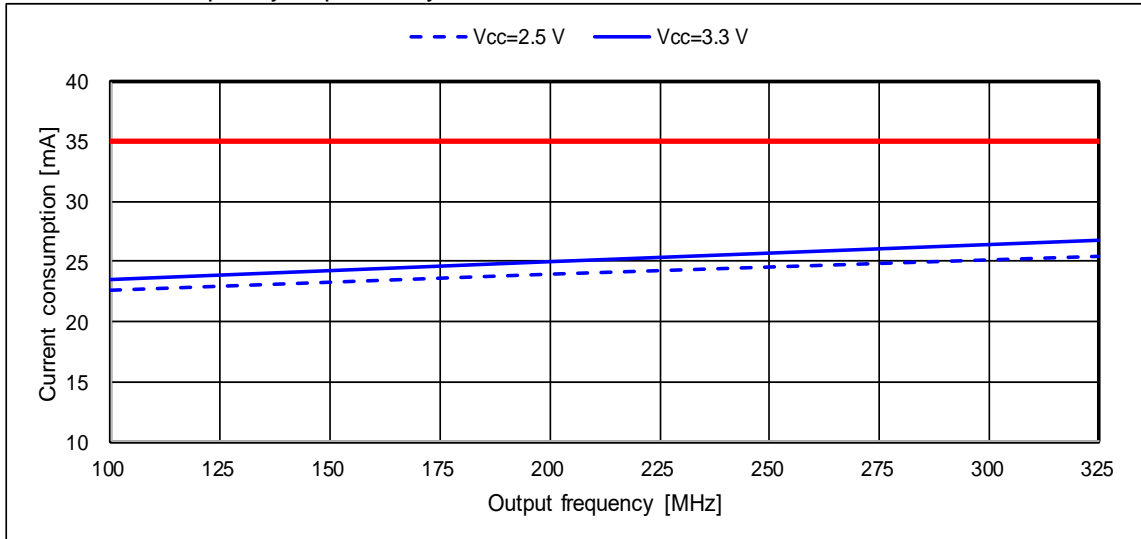
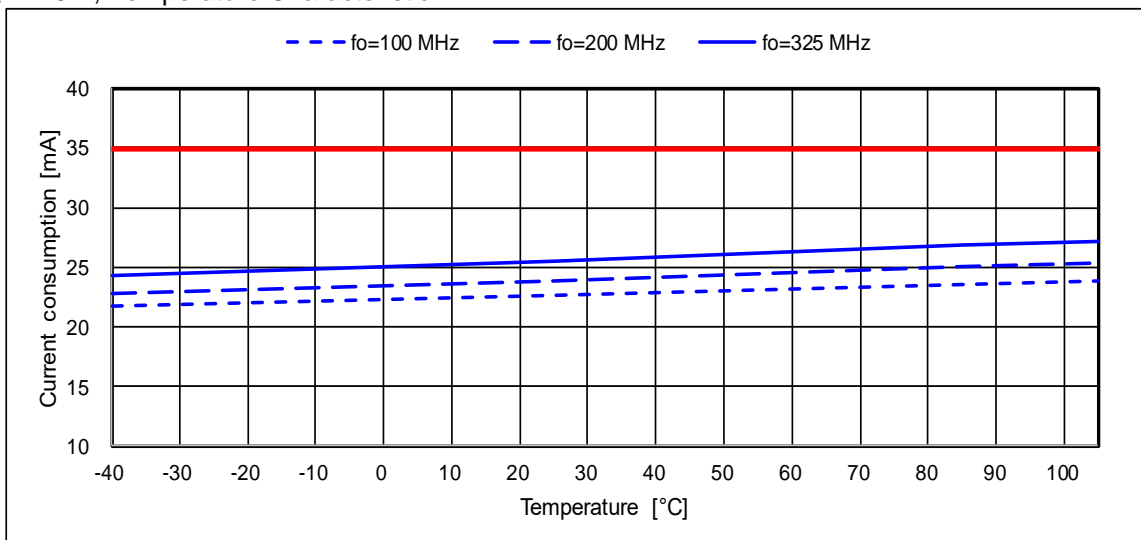
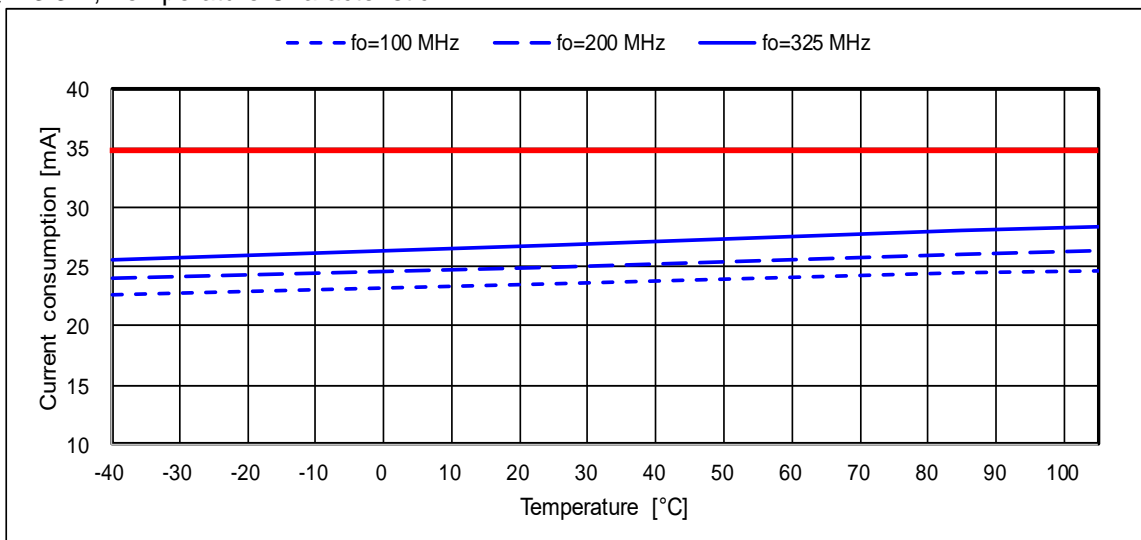
T_{use} = +25 °C, Frequency DependencyV_{CC} = 2.5 V, Temperature CharacteristicV_{CC} = 3.3 V, Temperature Characteristic

(7-3) Differential Output Rise / Fall Slew Rate Temperature Characteristic

fo = 100 MHz

Rise Slew Rate

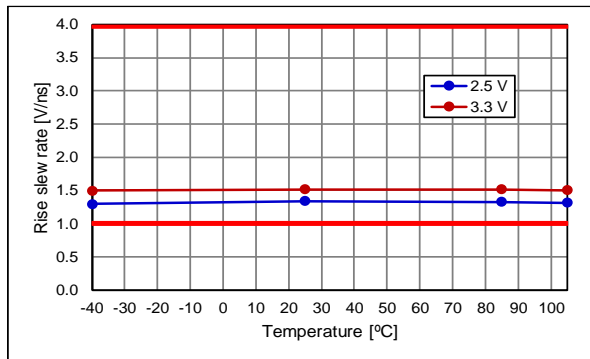

Fall Slew Rate

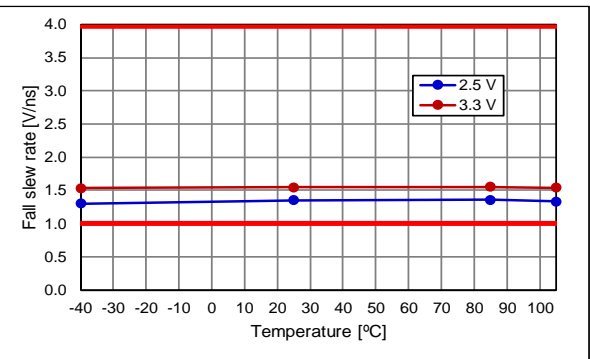

fo = 200 MHz

Rise Slew Rate

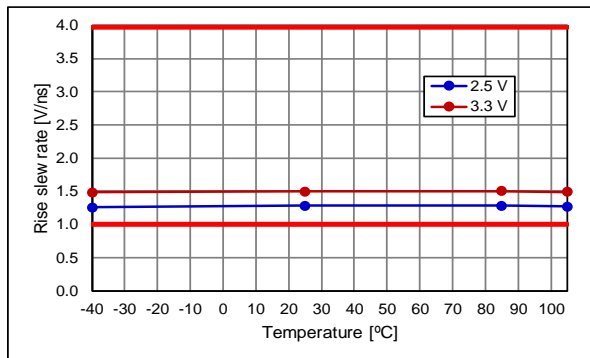

Fall Slew Rate

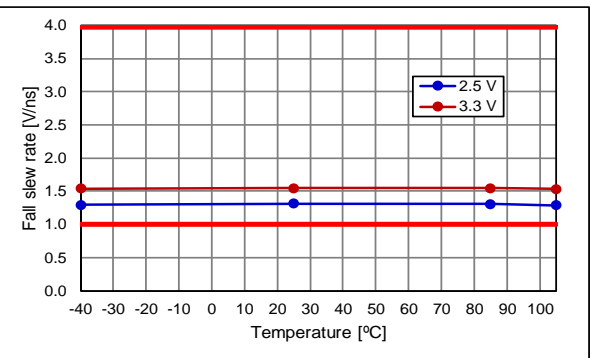

fo = 322.265625 MHz

Rise Slew Rate

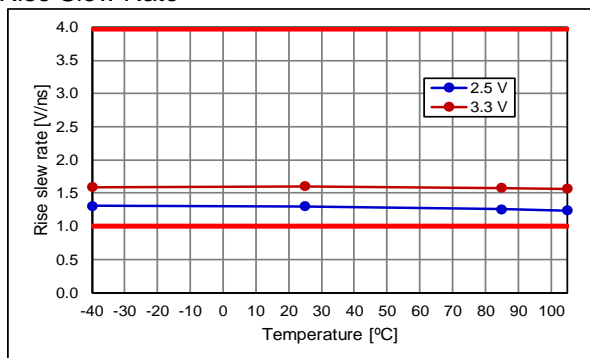

Fall Slew Rate

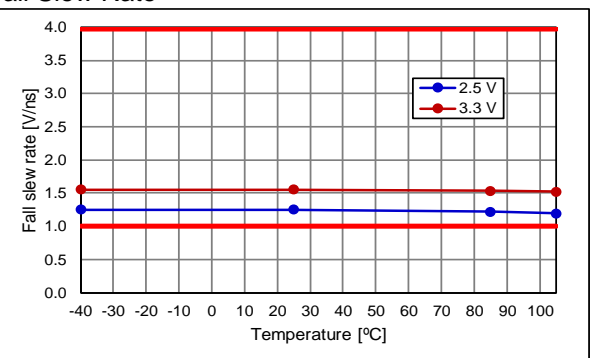

(7-4) Symmetry Temperature Characteristic

fo = 100 MHz

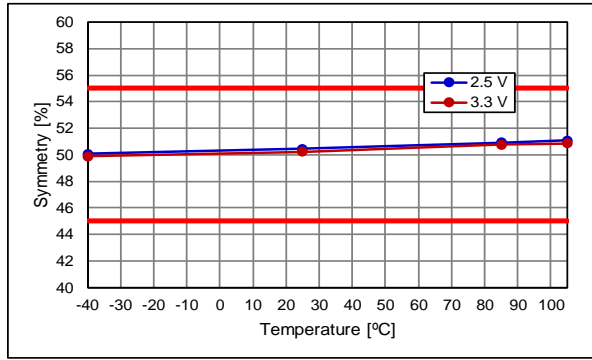

fo = 200 MHz

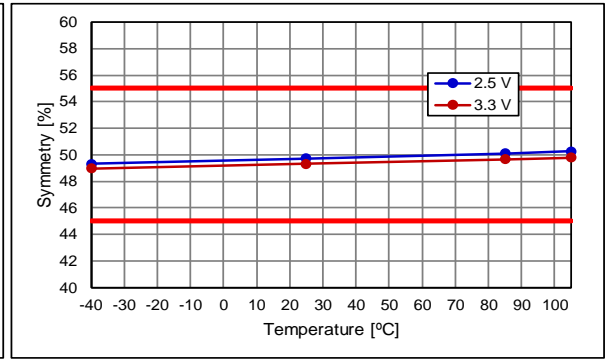

fo = 322.265625 MHz

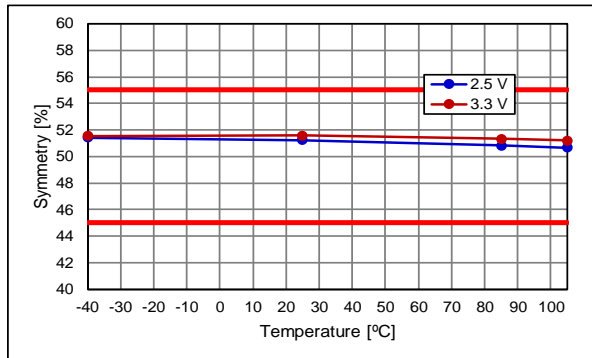

(7-5) Output Voltage Temperature Characteristic

V_{OH}

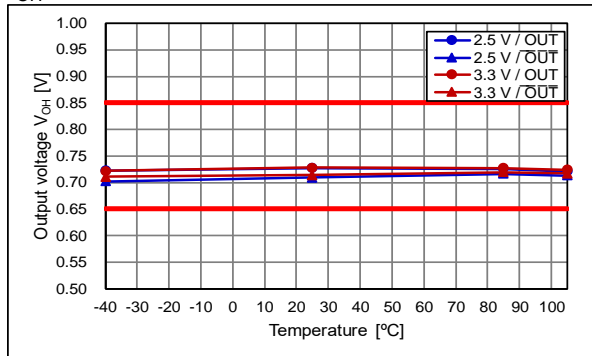

V_{OL}

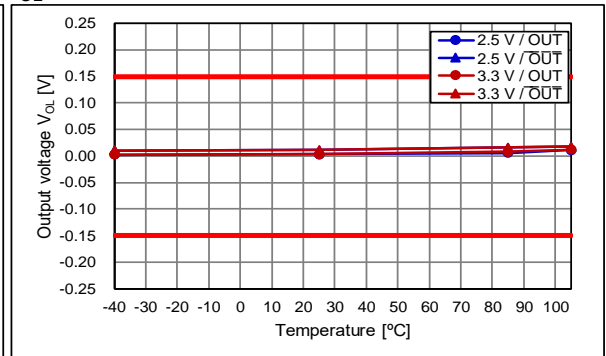

(7-6) Crossing Voltage Temperature Characteristic

fo = 100 MHz

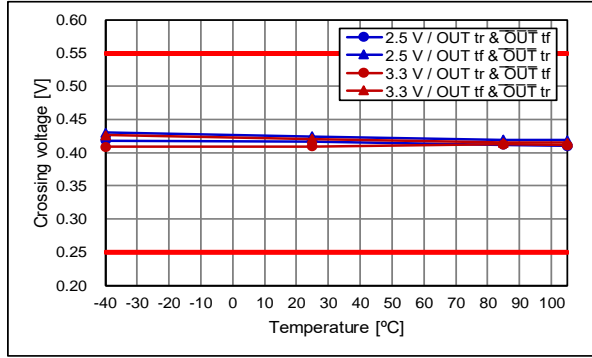

fo = 200 MHz

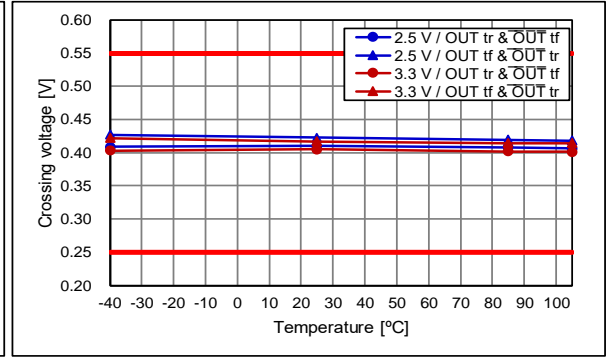

fo = 322.265625 MHz

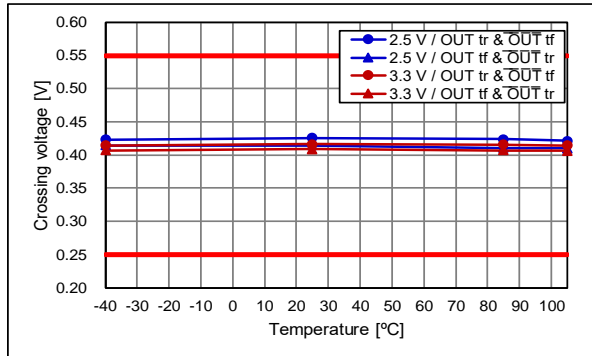

(7-7) Crossing Voltage Variation Temperature Characteristic

fo = 100 MHz

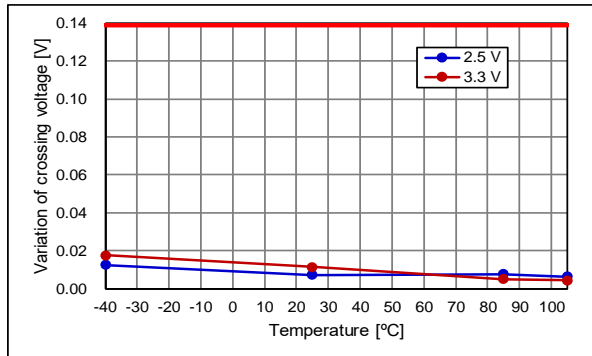

fo = 200 MHz

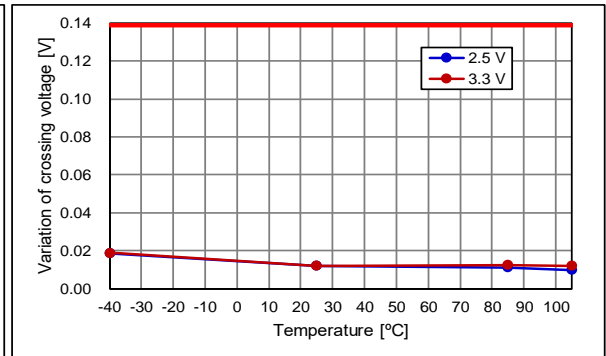

fo = 322.265625 MHz

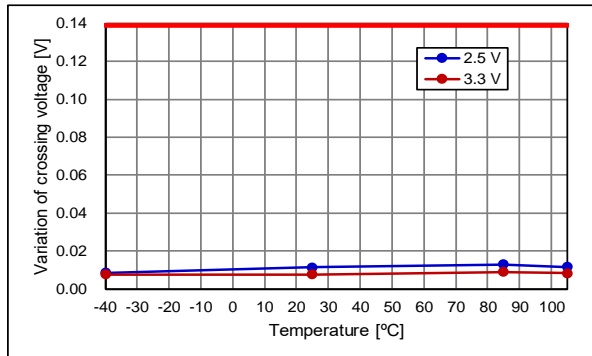

(7-8) Phase Noise and Phase Jitter

fo = 100 MHz, T_use = +25 °C

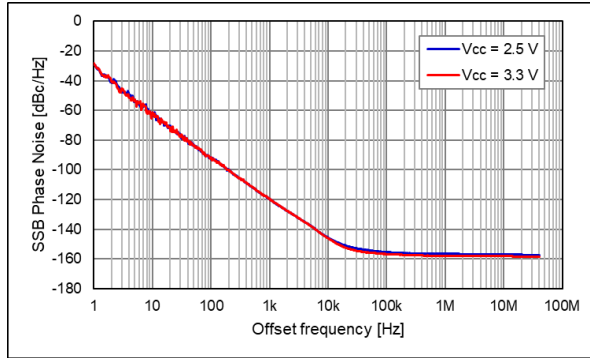

V _{CC}	Phase Jitter*
2.5 V	126 fs
3.3 V	145 fs

* Offset frequency: 12 kHz to 20 MHz

fo = 125 MHz, T_use = +25 °C

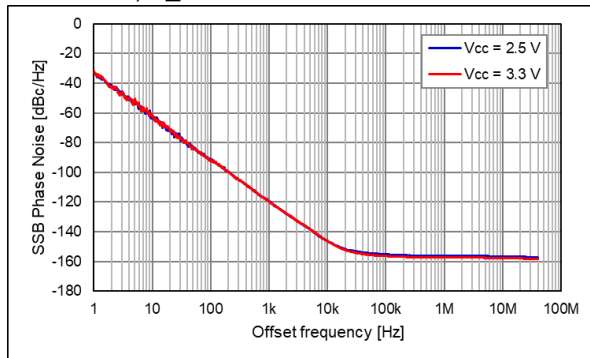

V _{CC}	Phase Jitter*
2.5 V	121 fs
3.3 V	107 fs

* Offset frequency: 12 kHz to 20 MHz

fo = 156.25 MHz, T_use = +25 °C

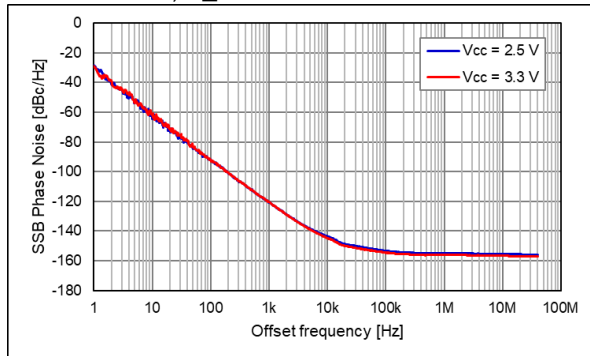

V _{CC}	Phase Jitter*
2.5 V	110 fs
3.3 V	96 fs

* Offset frequency: 12 kHz to 20 MHz

fo = 200 MHz, T_use = +25 °C

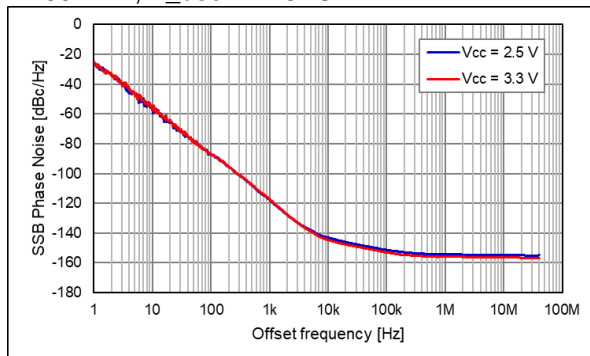

V _{CC}	Phase Jitter*
2.5 V	94 fs
3.3 V	78 fs

* Offset frequency: 12 kHz to 20 MHz

(7-8) Phase Noise and Phase Jitter [cont'd]

fo = 322.265625 MHz, T_use = +25 °C

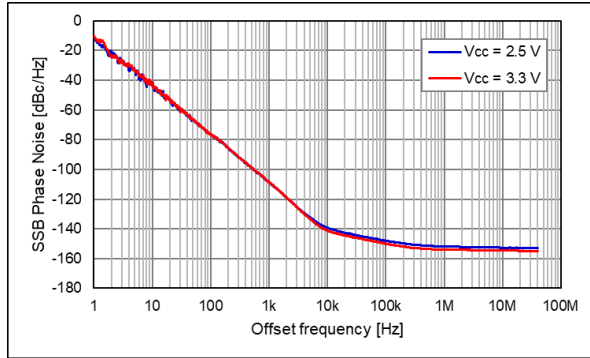

V _{CC}	Phase Jitter*
2.5 V	75 fs
3.3 V	60 fs

* Offset frequency: 12 kHz to 20 MHz

[8] Test Circuit

(8-1) Waveform Observation and Current Consumption Test Setup

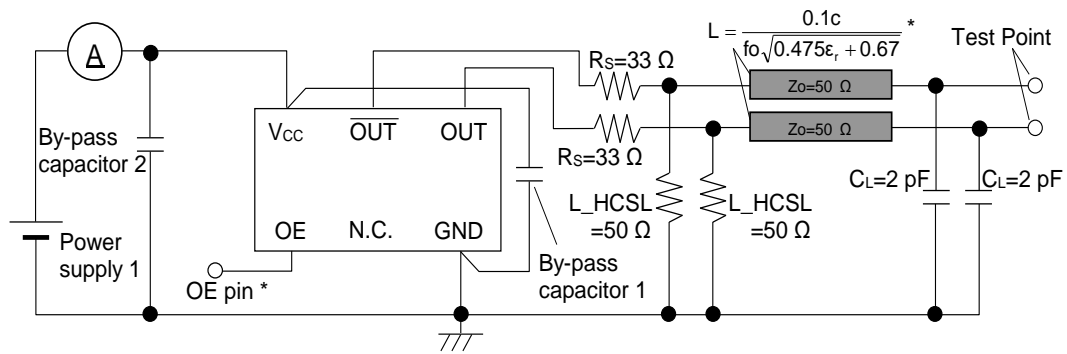

* Each output trace should be same length

* To measure Disable Current, OE terminal is connected to GND

(8-2) Conditions

(1) Oscilloscope

The bandwidth should be a minimum of 5 times wider than the measurement frequency
The probe ground should be placed closely to the test point and the lead length should be as short as possible

(2) A 0.1 μF and a 10 μF bypass capacitor should be connected between V_{CC} and GND pins located close to the device

(3) Use a current meter with a low internal impedance

(4) Power Supply

Power supply startup time (0 % V_{CC} \rightarrow 90 % V_{CC}) should be more than 150 μs

Power supply impedance should be as low as possible

(8-3) Timing Chart

(1) Output Waveform and Level

OUT, $\overline{\text{OUT}}$ Output Waveform

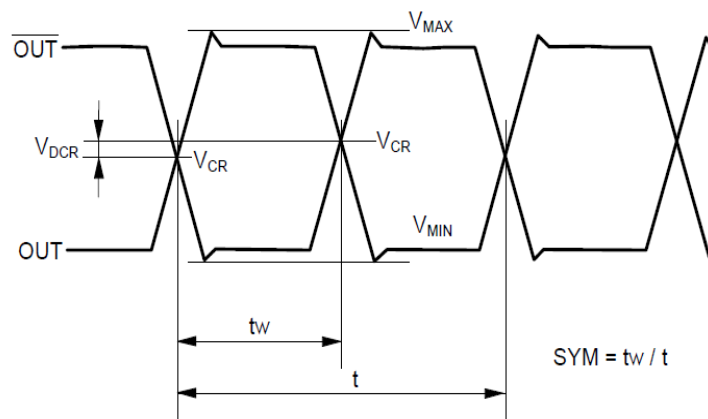

Differential Output Waveform

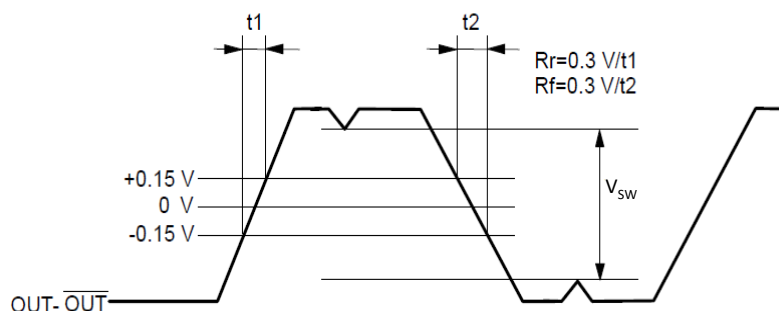

(8-3) Timing Chart (cont'd)

(2) Output Frequency Timing

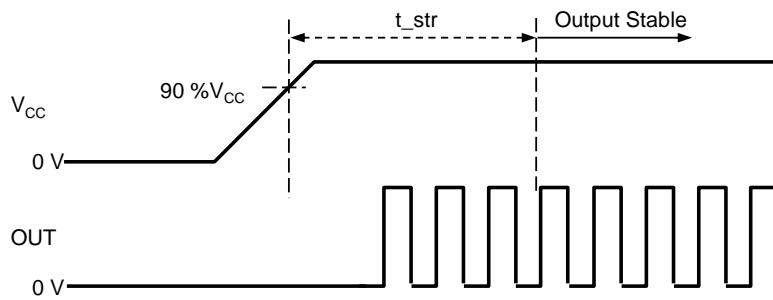

(3) OE Function and Timing

OE Terminal	Osc. Circuit	Output status
"H" or OPEN	Oscillation	Specified frequency is output: Enable
"L"	Oscillation	Output becomes high impedance: Disable

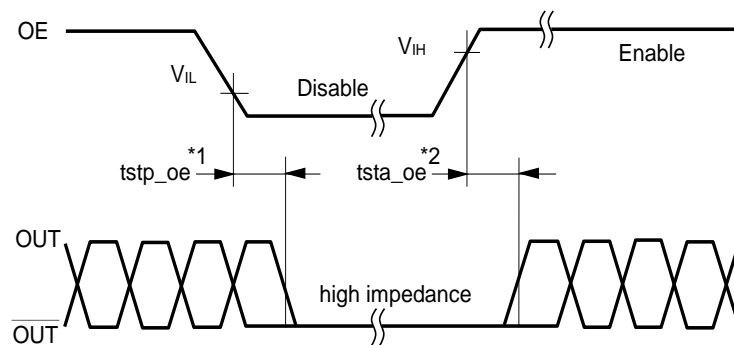

*1 The time from $OE=V_{IL}$ to output = disable (high impedance)

*2 The time from $OE=V_{IH}$ to starting output

* OE level should not exceed supply voltage when using the OE function

Please note that during startup the OE voltage level should not exceed the supply voltage

[9] Outline Drawing and Recommended Footprint

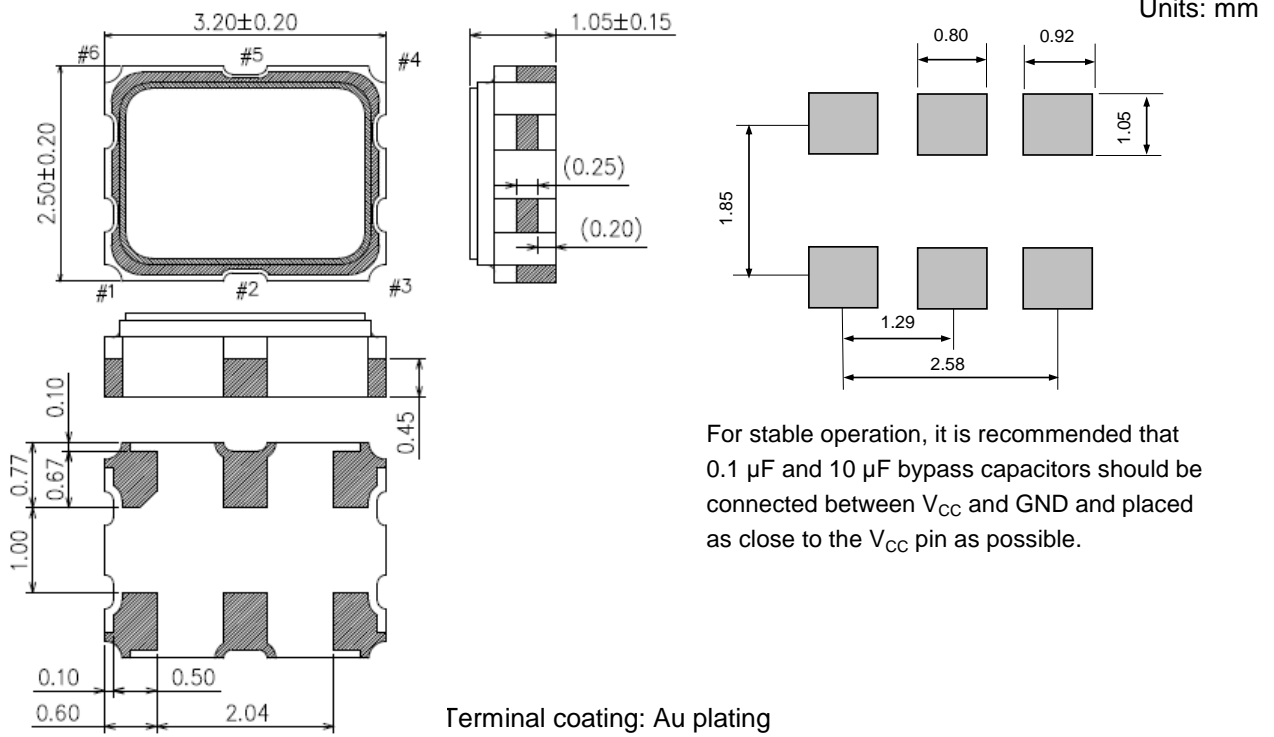

For stable operation, it is recommended that 0.1 μ F and 10 μ F bypass capacitors should be connected between V_{CC} and GND and placed as close to the V_{CC} pin as possible.

Reference weight Typ.: 25.6 mg

Terminal Assignment

Pin #	Connection	Function
#1	OE	OE terminal / active high
		OE function
		"H" or OPEN
		"L"
#2	NC	—
#3	GND	GND terminal
#4	OUT	Output terminal (Positive)
#5	$\overline{\text{OUT}}$	Output terminal (Negative)
#6	V_{CC}	V_{CC} terminal

Marking

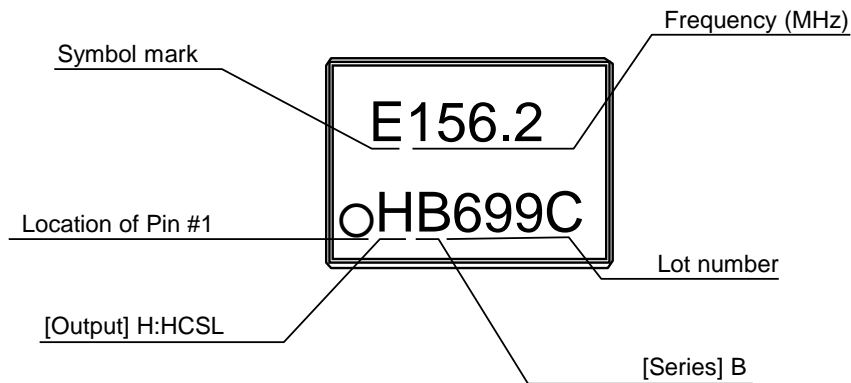

[10] Moisture Sensitivity Level and Electro-Static Discharge Ratings

(10-1) Moisture Sensitivity Level (MSL)

Parameter	Specification	Conditions
MSL	LEVEL 1	IPC/JEDEC J-STD-020D.1

(10-2) Electro-Static Discharge (ESD)

Parameter	Specification	Conditions
HBM	2 000 V Min.	EIAJ ED-4701-1 C111A, 100 pF, 1.5 k Ω , 3 times
MM	200 V Min.	EIAJ ED-4701-1 C111, 200 pF, 0 Ω , 1 time

[11] Reflow Profile

IPC/JEDEC J-STD-020D.1

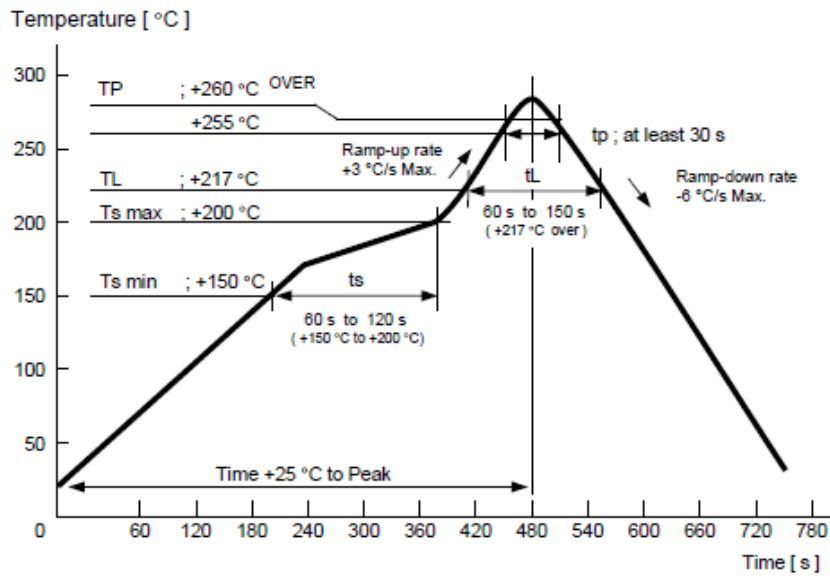

[12] Packing Information

(12-1) Packing Quantity

The last two digits of the Product Number (X1G005141xxxxxx) are a code that defines the packing quantity. The standard is "00" for a 2 000 pcs/Reel.

(12-2) Taping Specification

Subject to EIA-481, IEC-60286 and JIS C0806

(1) Tape Dimensions

Carrier Tape Material: PS (Polystyrene)

Top Tape Material: PET (Polyethylene Terephthalate) +PE (Polyethylene)

Units: mm

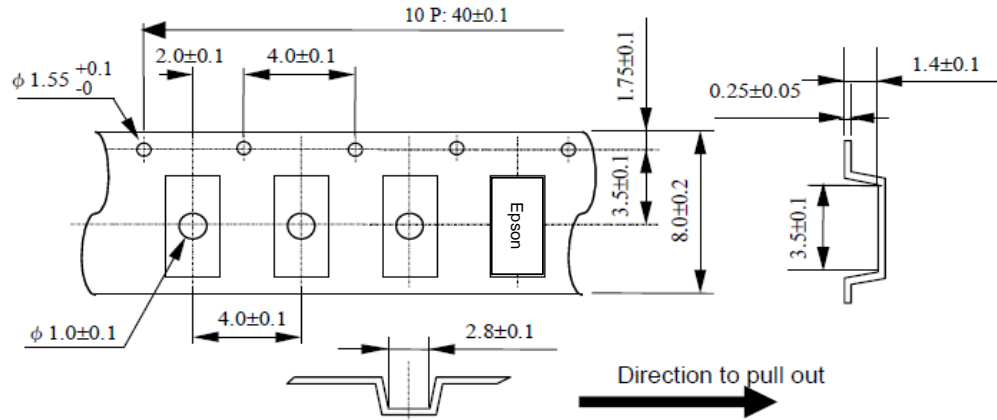

(2) Reel Dimensions

Center Material: PS (Polystyrene)

Reel Material: PS (Polystyrene)

Units: mm

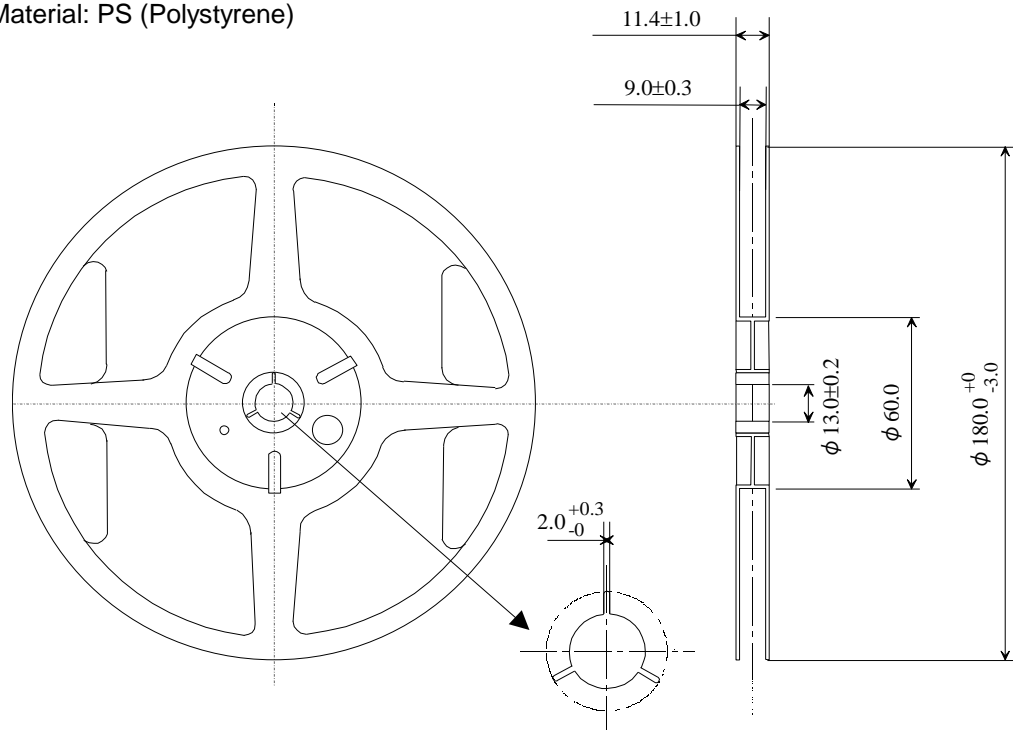

(12-3) Storage Environment

We recommend to keep less than +30 °C and 85 %RH of humidity in a packed condition, and to use it less than 6 months after delivery.

[13] Handling Precautions

Prior to using this product, please carefully read the section entitled "Precautions" on our Web site (<https://www5.epsondevice.com/en/information/#precaution>) for instructions on how to handle and use the product properly to ensure optimal performance of the product in your equipment.

Before using the product under any conditions other than those specified therein, please consult with Epson to verify and confirm that the performance of the product will not be negatively affected by use under such conditions.

In addition to the foregoing precautions, in order to avoid degrading the performance of the product, we strongly recommend that you DO NOT use the product under ANY of the following conditions:

- (1) Mounting the product on a board using water-soluble solder flux without completely removing the flux residue from the board. The residue of such flux is soluble in water or water-soluble cleaning agents and the residue, especially the residues which contain active halogens, will negatively affect the performance and reliability of the product.
- (2) Using the product in any manner that will result in any shock or impact to the product.
- (3) Using the product in places where the product is exposed to water, chemicals, organic solvent, sunlight, dust, corrosive gasses, or other materials.
- (4) Using the product in places where it is exposed to static electricity or electromagnetic waves.
- (5) Applying ultrasonic cleaning without advance verification and confirmation that the product will not be affected by such a cleaning process which may damage the crystal.
- (6) Using the product under any other conditions that may negatively affect the performance and/or reliability of the product.
- (7) Using a power supply with ripple may cause of incorrect operation or degradation of phase noise characteristics, so please evaluate before use.
- (8) Supply voltage should be increased monotonically.
In addition, please do not power on at midpoint potential since that may cause malfunction or not output.
- (9) Frequency aging is calculated from environmental tests results to estimate the amount of frequency variation over time. This does not guarantee the length of the product's life-cycle.

Should any customer use the product in any manner contrary to the precautions and/or advice herein, such use shall be done at the customer's own risk.

PROMOTION OF ENVIRONMENTAL MANAGEMENT SYSTEM CONFORMING TO INTERNATIONAL STANDARDS

At Seiko Epson, all environmental initiatives operate under the Plan-Do-Check-Action (PDCA) cycle designed to achieve continuous improvements. The environmental management system (EMS) operates under the ISO 14001 environmental management standard.

All of our major manufacturing and non-manufacturing sites, in Japan and overseas, completed the acquisition of ISO 14001 certification.



ISO 14000 is an international standard for environmental management that was established by the International Standards Organization in 1996 against the background of growing concern regarding global warming, destruction of the ozone layer, and global deforestation.

WORKING FOR HIGH QUALITY

In order provide high quality and reliable products and services than meet customer needs, Seiko Epson made early efforts towards obtaining ISO9000 series certification and has acquired ISO9001 for all business establishments in Japan and abroad. We have also acquired IATF 16949 certification that is requested strongly by major manufacturers as standard.

IATF 16949 is the international standard that added the sector-specific supplemental requirements for automotive industry based on ISO9001.

■ Explanation of marks used in this datasheet

	<p>● Pb free.</p>
	<p>● Complies with EU RoHS directive. *About the products without the Pb-free mark. Contains Pb in products exempted by EU RoHS directive (Contains Pb in sealing glass, high melting temperature type solder or other)</p>

NOTICE: PLEASE READ CAREFULLY BELOW BEFORE THE USE OF THIS DOCUMENT ©Seiko Epson Corporation 2020

- The content of this document is subject to change without notice. Before purchasing or using Epson products, please contact with sales representative of Seiko Epson Corporation ("Epson") for the latest information and be always sure to check the latest information published on Epson's official web sites and resources.
- This document may not be copied, reproduced, or used for any other purposes, in whole or in part, without Epson's prior consent.
- Information provided in this document including, but not limited to application circuits, programs and usage, is for reference purpose only. Epson makes no guarantees against any infringements or damages to any third parties' intellectual property rights or any other rights resulting from the information. This document does not grant you any licenses, any intellectual property rights or any other rights with respect to Epson products owned by Epson or any third parties.
- Using Epson products, you shall be responsible for safe design in your products; that is, your hardware, software, and/or systems shall be designed enough to prevent any critical harm or damages to life, health or property, even if any malfunction or failure might be caused by Epson products. In designing your products with Epson products, please be sure to check and comply with the latest information regarding Epson products (including, but not limited to this document, specifications, data sheets, manuals, and Epson's web site). Using technical contents such as product data, graphic and chart, and technical information, including programs, algorithms and application circuit examples under this document, you shall evaluate your products thoroughly both in stand-alone basis and within your overall systems. You shall be solely responsible for deciding whether to adopt/use Epson products with your products.
- Epson has prepared this document carefully to be accurate and dependable, but Epson does not guarantee that the information is always accurate and complete. Epson assumes no responsibility for any damages you incurred due to any misinformation in this document.
- No dismantling, analysis, reverse engineering, modification, alteration, adaptation, reproduction, etc., of Epson products is allowed.
- Epson products have been designed, developed and manufactured to be used in general electronic applications and specifically requires particular quality or extremely high reliability in order to refrain from causing any malfunction or failure leading to critical harm to life and health, serious property damage, or severe impact on society, including, but not limited to listed below ("Specific Purpose"). Therefore, you are strongly advised to use Epson products only for the Anticipated Purpose. Should you desire to purchase and use Epson products for Specific Purpose, Epson makes no warranty and disclaims with respect to Epson products, whether express or implied, including without limitation any implied warranty of merchantability or fitness for any Specific Purpose. Please be sure to contact our sales representative in advance, if you desire Epson products for Specific Purpose:
Space equipment (artificial satellites, rockets, etc.) / Transportation vehicles and their control equipment (automobiles, aircraft, trains, ships, etc.) / Medical equipment / Relay equipment to be placed on sea floor / Power station control equipment / Disaster or crime prevention equipment / Traffic control equipment / Financial equipment
Other applications requiring similar levels of reliability as the above
- Epson products listed in this document and our associated technologies shall not be used in any equipment or systems that laws and regulations in Japan or any other countries prohibit to manufacture, use or sell. Furthermore, Epson products and our associated technologies shall not be used for the purposes of military weapons development (e.g. mass destruction weapons), military use, or any other military applications. If exporting Epson products or our associated technologies, please be sure to comply with the Foreign Exchange and Foreign Trade Control Act in Japan, Export Administration Regulations in the U.S.A (EAR) and other export-related laws and regulations in Japan and any other countries and to follow their required procedures.
- Epson assumes no responsibility for any damages (whether direct or indirect) caused by or in relation with your non-compliance with the terms and conditions in this document or for any damages (whether direct or indirect) incurred by any third party that you give, transfer or assign Epson products.
- For more details or other concerns about this document, please contact our sales representative.
- Company names and product names listed in this document are trademarks or registered trademarks of their respective companies.