

150mA Ultra Low Dropout Voltage Regulator

DESCRIPTION

The TS2951 are low power voltage regulators. These devices are excellent choice for use in battery-powered applications such as cordless telephone, radio control systems, and portable computers.

The TS2951 is features very low quiescent current (75µA Typ.) and very low drop output voltage (Typ. 40µV at light load and 380mV at 100mA). This includes a tight initial tolerance of 1% (A version), extremely good load and line regulation 0.05% typ. and very low output temperature coefficient, making the TS2951 useful as a low-power voltage reference.

TS2951 have other key additional feature. The error flag output feature is used as power-on reset for warn of a low output voltage, due to following batteries on input. The logic-compatible shutdown input which enable the regulator to be switched on/off. The regulator output voltage may be pin-strapped for a 5.0 & 3.3 & 3.0 of programmed from 1.24V to 29V with external pair of resistors. Using of as design, processing and testing techniques make TS2951 superior over similar products.

FEATURES

- Output voltage available in 5V, 3V & 3.3V
- Low quiescent current and low dropout voltage
- Extremely tight load and line regulation
- Very low temperature coefficient
- Need only 1µF for stability
- Use as Regulator or Reference
- Stable with low-ESR output capacitors
- Current and thermal limiting
- Error Flag warns of output dropout
- Logic-Controlled electronic shutdown
- Additional voltage tap
- Output programmable from 1.24 to 29V
- RoHS compliant
- Halogen-free

APPLICATION

- Battery powered systems
- SMPS Post-Regulator and Voltage Reference
- Voltage Reference

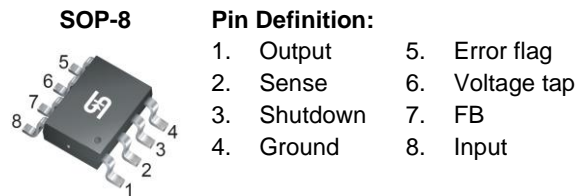

Notes: MSL 3 (Moisture Sensitivity Level) per J-STD-020

TYPICAL APPLICATION CIRCUIT

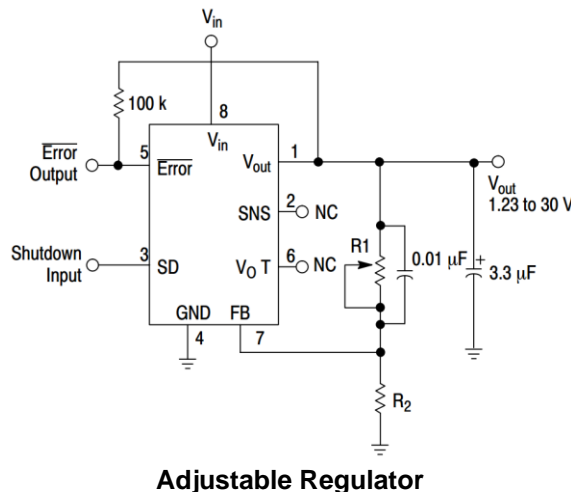

ABSOLUTE MAXIMUM RATINGS			
PARAMETER	SYMBOL	LIMIT	UNIT
Input Supply Voltage	V_{IN}	-0.3 ~ +30	V
Feedback Input Voltage	V_{FB}	-1.5 ~ +30	V
Shutdown Input Voltage	$V_{SHUTDOWN}$	-0.3 ~ +30	V
Error Comparator Output Voltage	V_{ERROR}	-0.3 ~ +30	V
Power Dissipation	P_D	Internally Limited	W
Operating Junction Temperature Range	T_J	-40 ~ +125	°C
Storage Temperature Range	T_{STG}	-65 ~ +150	°C

THERMAL PERFORMANCE			
PARAMETER	SYMBOL	LIMIT	UNIT
Junction to Case Thermal Resistance	$R_{\theta JC}$	45	°C/W
Junction to Ambient Thermal Resistance	$R_{\theta JA}$	180	°C/W

Notes: $R_{\theta JA}$ is the sum of the junction-to-case and case-to-ambient thermal resistances. The case thermal reference is defined at the solder mounting surface of the drain pins. $R_{\theta JA}$ is guaranteed by design while $R_{\theta CA}$ is determined by the user's board design. $R_{\theta JA}$ shown below for single device operation on FR-4 PCB in still air.

ELECTRICAL SPECIFICATIONS ($V_{IN}=V_{OUT}+1V$, $T_A=25^\circ C$, unless otherwise specified.)					
PARAMETER	CONDITIONS (Note 2)	MIN	TYP	MAX	UNIT
Output Voltage	$T_J=25^\circ C$	0.985	5.0	1.015	V
	Full Operating temp	0.980	3.3	1.020	
	$100\mu A \leq I_L \leq 100mA$	0.975	3.0	1.025	
Output Voltage Temperature Coefficient (Note 1)		--	50	150	ppm/°C
		--	20	100	
Line Regulation(Note 3)	$6V \leq V_{IN} \leq 30V$ (Note 4)	--	0.04	0.2	%
Load Regulation(Note 3)	$100\mu A \leq I_L \leq 100mA$	--	0.1	0.3	%
Dropout Voltage(Note 5)	$I_L=100\mu A$	--	50	80	mV
	$I_L=100mA$	--	380	450	mV
Ground Current	$I_L=100\mu A$	--	75	120	μA
	$I_L=100mA$	--	8	12	mA
Dropout Ground Current	$V_{IN}=4.5V$, $I_L=100\mu A$	--	110	170	μA
Current Limit	$V_{OUT}=0$	--	160	200	mA
Thermal Regulation		--	0.05	0.2	%W
Output Noise, 10Hz to 100KHz Bypass=0.01uF	$C_L=1\mu F$	--	430	--	μV/ rms
	$C_L=3.3\mu F$	--	100	--	
	$C_L=200\mu F$	--	160	--	
Reference Voltage(Note 6)		1.21	1.235	1.27	V
	$V_{REF} \leq V_{OUT} \leq (V_{in}-1V)$, $2.3 \leq V_{in} \leq 30V$, $100\mu A \leq I_L \leq 100mA$, $T_J \leq T_J$ (max)	1.185	1.235	1.285	V

ELECTRICAL SPECIFICATIONS ($V_{IN}=V_{OUT}+1V$, $T_A=25^{\circ}C$, unless otherwise specified.)					
PARAMETER	CONDITIONS ^(Note 2)	MIN	TYP	MAX	UNIT
Feedback Pin Bias Current		--	20	40	nA
Reference Voltage Temperature Coefficient ^(Note 7)		--	20	--	ppm/ $^{\circ}C$
Feedback Pin Bias Current Temperature Coefficient		--	0.1	--	nA/ $^{\circ}C$
Output Leakage Current	$V_{OH}= 30V$	--	0.01	1	μA
Output Low Voltage	$V_{IN}= 4.5V$, $I_{OL} = 400\mu A$	--	150	250	mV
Upper Threshold Voltage ^(Note 8)		40	60	--	mV
Power Threshold Voltage ^(Note 8)		--	75	95	mV
Hysteresis ^(Note 8)		--	15	--	mV
Output Logic Voltage	Low (Regulator ON)	--	1.3	0.7	V
	High (Regulator OFF)	2.0	1.3	--	
Shut down Pin Current	$V_S = 2.4V$	--	30	50	μA
	$V_S = 30V$	--	450	600	
Regulator Output Current shutdown		--	3	10	μA

Note:

- Output voltage temperature coefficients defined as the worst case voltage change divided by the total temperature range.
- Unless otherwise specified all limits guaranteed for $T_J= 25^{\circ}C$, $V_{IN}= 6V$, $I_L= 100\mu A$ and $C_L= 100\mu F$. Additional conditions for the 8-pin versions are feedback tied to 5V, 3.3V & 3V tap output Sense ($V_{OUT} = 5V$, 3.3V & 3V) and shutdown $\leq 0.8V$.
- Regulation is measured at constant junction temperature, using pulse testing with a low duty cycle. Changes in output voltage due to heating effects are covered under the specification for thermal regulation.
- Line regulation for the TS2951 is tested at $85^{\circ}C$ for $I_L= 1mA$. For $I_L= 100\mu A$ and $T_J= 125^{\circ}C$, line regulation is guaranteed by design to 0.2%.
- Dropout Voltage is defined as the input to output differential at which the output voltage drops 100mV below its nominal value measured at 1V differential at very low value of programmed output voltage, the minimum input supply voltage of 2V (2.3V over temperature) must be taken in to account.
- $V_{REF} \leq V_{OUT} \leq (V_{in}-1V)$, $2.3 \leq V_{in} \leq 30V$, $100\mu A \leq I_L \leq 100mA$, $T_J \leq T_J (max)$.
- Reference voltage temperature coefficient is defined as the worst case voltage change divided by the total temperature range.
- Comparator thresholds are expressed in terms of a voltage differential at the feedback terminal below the nominal reference voltage measured at 6V input. To express these thresholds in terms of output voltage change, multiply by the error amplifier gain= $V_{OUT} / V_{REF} = (R1+R2) / R2$. For example, at a programmed output voltage of 5V, the Error output is guaranteed to go low when the output drops by $95 mV \times 5V / 1.250 = 384mV$. Thresholds remain constant as a percent of V_{OUT} as V_{OUT} is varied with the dropout warning occurring at typically 5% below nominal, 7.5% guaranteed.

ORDERING INFORMATION

OUTPUT VOLTAGE	ORDERING CODE	PACKAGE	PACKING	DEVICE MARKING
5.0V	TS2951CS50 RLG	SOP-8	2,500pcs / 13" Reel	TS2951 50
3.3V	TS2951CS33 RLG	SOP-8	2,500pcs / 13" Reel	TS2951 33
3.0V	TS2951CS30 RLG	SOP-8	2,500pcs / 13" Reel	TS2951 30

BLOCK DIAGRAM

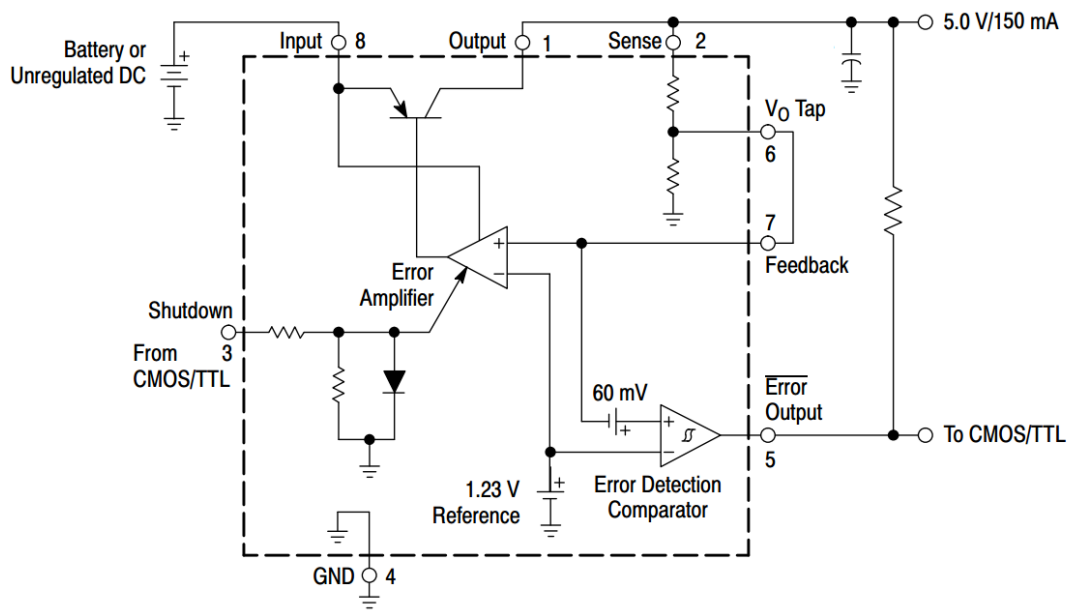

APPLICATION INFORMATION

External Capacitors

For the stability of the TS2951 requires a 1.0 μ F (0.22 μ F is recommended for 3.0V & 3.3V) or greater capacitor between output and ground. Oscillation could occur without this capacitor. The tantalum or aluminum electrolytic works fine; could use the film type work but are not cost efficient. For the operation of below -25 °C solid tantalum is recommended since the many aluminum type have electrolytes the freeze at about -30 °C. The ESR of about 5 Ω or less and resonant frequency above 500KHz are most important parameter in the value of Capacitor. The Capacitors value can be increased without any limit. At lower values of output current, less output capacitance is required for stability. For the currents below 10mA the value of capacitor can be reduce to 0.33 μ F and 0.1 μ F for 1mA. More output capacitance needed for the 8-pin version at voltage below 5V since it runs the error amplifier at lower gain. At worst case 3.3 μ F or greater must be used for condition of 100mA load at 1.250V output.

The TS2951 is not like other low dropout regulators will remain stable and regulation with no load in addition to the internal voltage divider. This feature very important in application, it is like CMOS RAM keep-alive. The TS2951 output voltage is set with minimum load of 1 μ A and external resistors.

If at the input of TS2951 connected to battery or between AC filter capacitor and input is 10 inches wire then 1 μ F tantalum or aluminum electrolytic capacitor should be connected between input and ground. Instability can occur if stray capacitor to feedback terminal pin 7 of the TS2951. This could cause more problems when using higher value of external to set the output voltage. To fix this problem the 100pF capacitor between output and feedback and increasing output capacitance to 3.3 μ F.

Reducing Output Noise

It could be an advantage to reduce the AC noise present at the output. One method is to reduce the regulator bandwidth by increasing the value of the output capacitor. This is the only method that noise could reduce on the TS2951, but is relatively inefficient, as increasing capacitor from 1 μ F to 220 μ F only decreases the noise from 430 μ V to 160 μ Vrms for a 100KHz bandwidth at 5V output. Noise could be also reduced by fourfold by a bypass capacitor across R1 since it reduces the high frequency gain from 4 to unity.

Pick $C_{bypass} = 1 / 2\pi R1 * 200\text{Hz}$ or choose 0.01 μ F when doing this, the output capacitor must be increased to 3.3 μ F to maintain stability. These change the output noise from 430 μ V/rms for a 100 kHz bandwidth 5V, 3.3V & 3V output. With the bypass capacitor added, noise no longer scales with output voltage so that improvements are more dramatic higher output voltage.

Error Detection Comparator Output

The Comparator produces a logic low output whenever the TS2951 output falls of regulation by more than around 5%. This is around 60 mV offset divided by the 1.235 reference voltage. Thus trip remains 5% below nominal regardless of the programmed output voltage of the regulator. The Figure 1 shows the timing diagram depicting the ERROR signal and the regulator output voltage as the TS2951 input is ramped up and down. The ERROR signal becomes low at around 1.3V input, it goes high around 5V input (input voltage at which $V_{OUT}=4.75V$). The TS2951 dropout voltage depending on the load, the input voltage trip point around 5V will vary with load current. The output voltage trip point is around 4.75V, it does not change with load. The error comparator has an open-collector output which requires an external pull-up resistor. Depending on the system requirement, the resistor maybe returned to 5 or 3.3V output or other supply voltage depending to the system requirements. For determining the size of the resistor, note that the output is sinking 400 μ A, this value adds to battery drain in a low better condition, recommended values 100K to 1M Ω . If the output is unused this resistor is not required.

APPLICATION INFORMATION (CONTINUE)

Programming The output Voltage

The TS2951 output voltage is programmable for any value from it reference voltage of 1.235V and it maximum rating of 30V. For example for 5 volt needs to pin-strapped and using the internal voltage divider by tying pin 1 to 2 and pin 7 to pin 6. There are two external resistor required for this programming. Refer to the below equation for the programming the output voltage:

$$V_{out} = V_{REF} \times (1 + R1/R2) + I_{FB} \times R1$$

The V_{REF} is 1.235V and I_{FB} is the feedback bias current, nominally -20nA. The minimum recommended load current of 1µA forces an upper limit of 1.2MΩ on value of R2, If no load presented the I_{FB} produces error of typically 2% in V_{OUT} which maybe eliminated at room temperature by trimming R1. To improve the accuracy chooses the value of R2=100K and this reduces the error by 0.17% and increases the resistor program current by 12µA. The TS2951 typically draw 60µA at no load with pin 2 open-circuit, and this value does not look much.

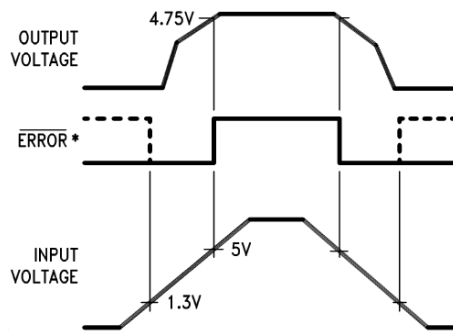

Error Output Timing

CHARACTERISTICS CURVES

($T_A = 25^\circ\text{C}$ unless otherwise noted)

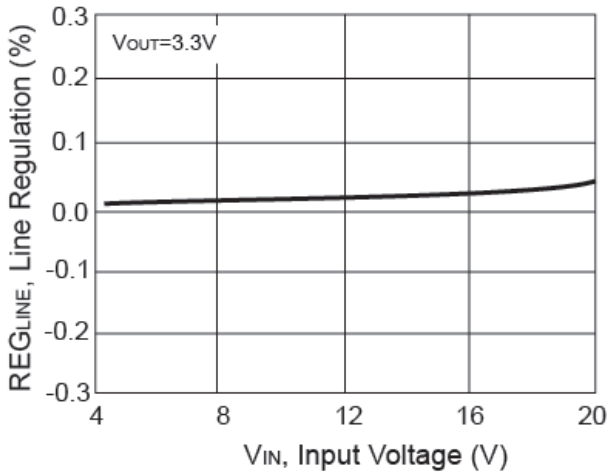

Figure 1. Line Regulation vs. Input Voltage

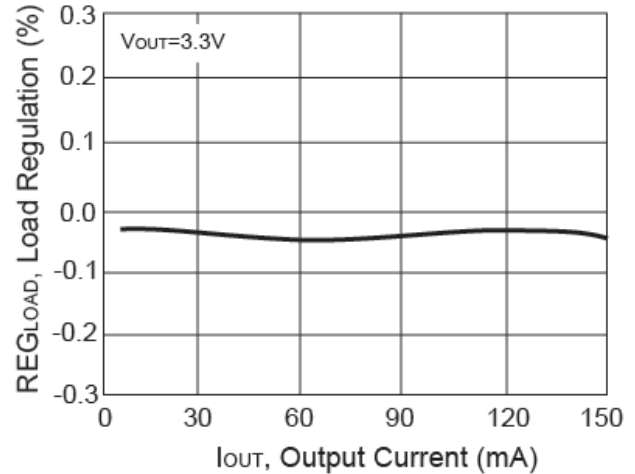

Figure 2. Load Regulation vs. Output Current

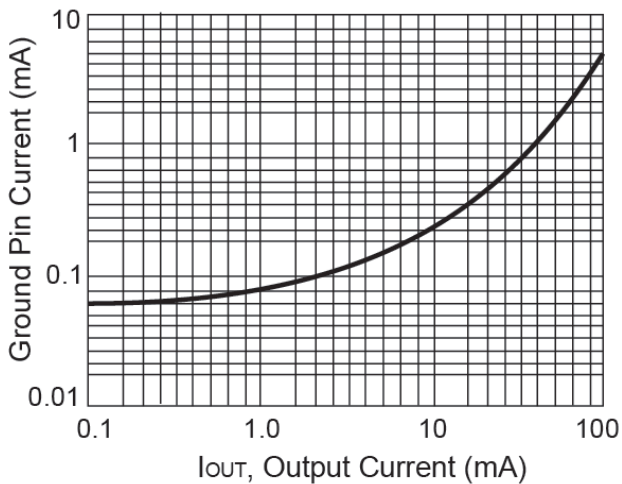

Figure 3. Ground Pin Current vs. Output Current

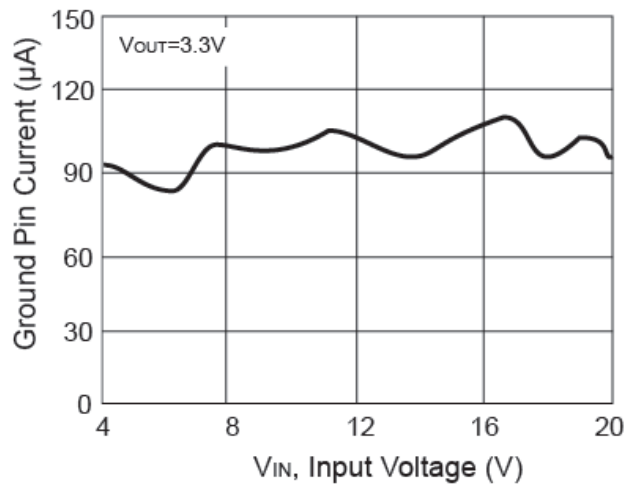

Figure 4. Ground Pin Current vs. Input Voltage

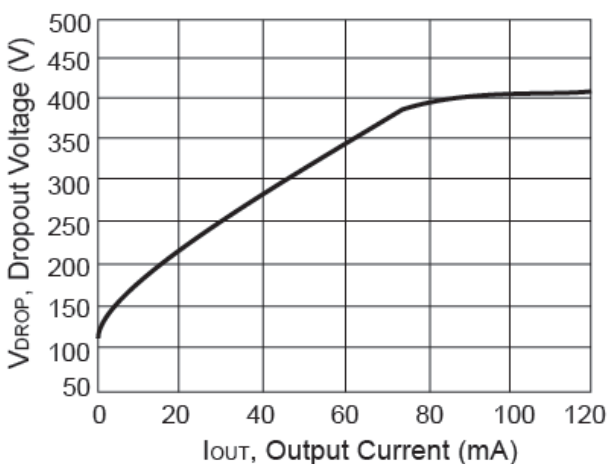

Figure 5. Dropout Voltage vs. Output Current

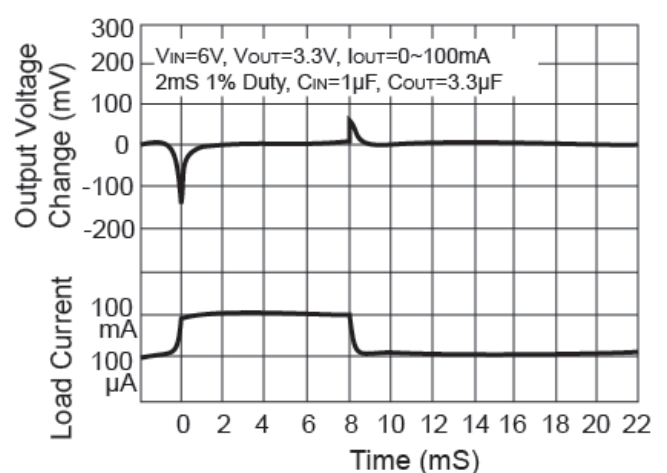
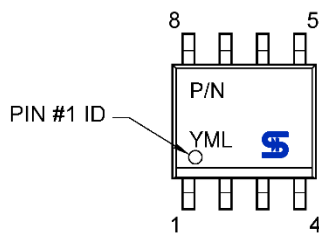
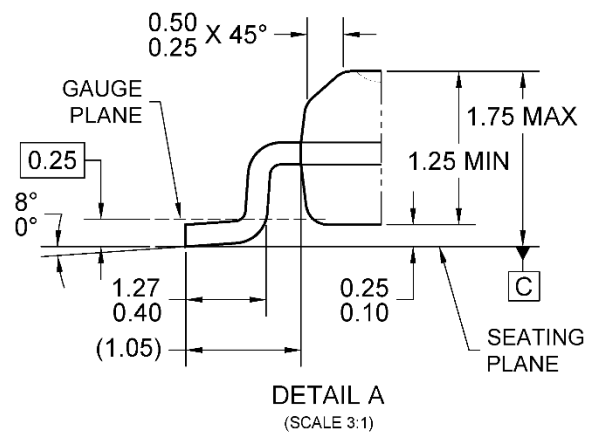
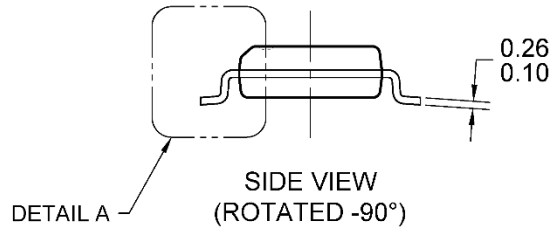
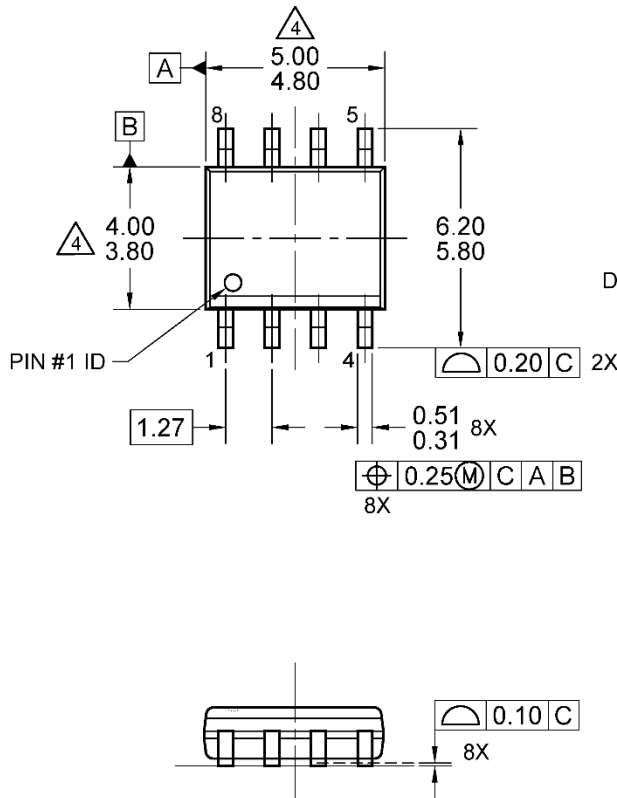

Figure 6. Load Transient Response

PACKAGE OUTLINE DIMENSIONS (Unit: Millimeters)

SOP-8



MARKING DIAGRAM

P/N = PRODUCT DEVICE CODE
 Y = YEAR CODE
 M = MONTH CODE FOR HALOGEN FREE PRODUCT
 O = JAN P = FEB Q = MAR R = APR
 S = MAY T = JUN U = JUL V = AUG
 W = SEP X = OCT Y = NOV Z = DEC
 L = LOT CODE

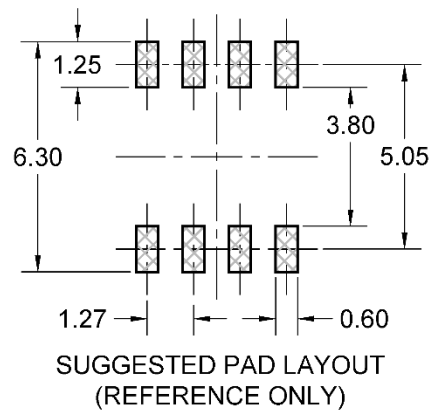

NOTES: UNLESS OTHERWISE SPECIFIED

1. ALL DIMENSIONS ARE IN MILLIMETERS.
2. DIMENSIONING AND TOLERANCING PER ASME Y14.5M-1994.
3. PACKAGE OUTLINE REFERENCE: JEDEC MS-012, ISSUE G, VARIATION AA.
4. MOLDED PLASTIC BODY DIMENSIONS DO NOT INCLUDE MOLD FLASH, PROTRUSIONS OR GATE BURRS.
5. DWG NO REF: HQ2SD07-SOP8STD-028 REV A.

Notice

Specifications of the products displayed herein are subject to change without notice. TSC or anyone on its behalf, assumes no responsibility or liability for any errors or inaccuracies.

Purchasers are solely responsible for the choice, selection, and use of TSC products and TSC assumes no liability for application assistance or the design of Purchasers' products.

Information contained herein is intended to provide a product description only. No license, express or implied, to any intellectual property rights is granted by this document. Except as provided in TSC's terms and conditions of sale for such products, TSC assumes no liability whatsoever, and disclaims any express or implied warranty, relating to sale and/or use of TSC products including liability or warranties relating to fitness for a particular purpose, merchantability, or infringement of any patent, copyright, or other intellectual property right.

The products shown herein are not designed for use in medical, life-saving, or life-sustaining applications. Customers using or selling these products for use in such applications do so at their own risk and agree to fully indemnify TSC for any damages resulting from such improper use or sale.