

10A, 650V SiC Merged PIN Schottky Diode

FEATURES

- Max junction temperature 175°C
- MPS structure for high ruggedness to forward current surge events
- High-speed switching possible
- High forward surge capability
- High-frequency operation
- Positive temperature coefficient on V_f
- RoHS compliant
- Halogen-free

APPLICATIONS

- General purpose
- Switch mode power supplies
- Power factor correction

MECHANICAL DATA

- Case: ITO-220AC-2L
- Molding compound meets UL 94V-0 flammability rating
- Terminal: Matte tin plated leads, solderable per J-STD-002
- Polarity: As circuit diagram
- Weight: 1.65g (approximately)

KEY PARAMETERS		
PARAMETER	VALUE	UNIT
I_F	10	A
V_{RRM}	650	V
I_{FSM}	84	A
$T_{J\ MAX}$	175	°C
Package	ITO-220AC-2L	
Configuration	Single die	



ITO-220AC-2L

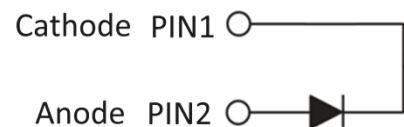

ABSOLUTE MAXIMUM RATINGS ($T_A = 25^\circ\text{C}$ unless otherwise noted)			
PARAMETER	SYMBOL	VALUE	UNIT
Repetitive peak reverse voltage	V_{RRM}	650	V
Reverse voltage, total rms value	$V_{R(RMS)}$	455	V
Continuous Rectified Forward Current @ $T_J = 143^\circ\text{C}$	I_F	10	A
Surge peak forward current 10ms single half sine-wave superimposed on rated load	$T_C = 25^\circ\text{C}$	I_{FSM}	84
	$T_C = 125^\circ\text{C}$		68
Junction temperature	T_J	-55 to +175	°C
Storage temperature	T_{STG}	-55 to +175	°C

THERMAL PERFORMANCE				
PARAMETER	SYMBOL	TYP	MAX	UNIT
Junction-to-case thermal resistance	$R_{\theta JC}$	2.0	2.4	$^{\circ}C/W$

ELECTRICAL SPECIFICATIONS ($T_A = 25^{\circ}C$ unless otherwise noted)					
PARAMETER	CONDITIONS	SYMBOL	TYP	MAX	UNIT
Forward voltage ⁽¹⁾	$I_F = 5A, T_J = 25^{\circ}C$	V_F	1.14	-	V
	$I_F = 10A, T_J = 25^{\circ}C$		1.34	1.45	V
	$I_F = 5A, T_J = 150^{\circ}C$		1.17	-	V
	$I_F = 10A, T_J = 150^{\circ}C$		1.53	-	V
	$I_F = 5A, T_J = 175^{\circ}C$		1.20	-	V
	$I_F = 10A, T_J = 175^{\circ}C$		1.60	1.85	V
Reverse current @ rated V_R ⁽²⁾	$T_J = 25^{\circ}C$	I_R	-	20	μA
	$T_J = 175^{\circ}C$		-	200	μA
Junction capacitance	$f = 1MHz, V_R = 1V$	C_J	475	-	pF
	$f = 1MHz, V_R = 200V$		70	-	pF
	$f = 1MHz, V_R = 400V$		45	-	pF
Capacitive Charge	$V_R = 400V$	Q_C	31	-	nC

Notes:

1. Pulse test with $PW = 0.3ms$
2. Pulse test with $PW = 30ms$

ORDERING INFORMATION		
ORDERING CODE	PACKAGE	PACKING
TSCDF10065G1	ITO-220AC-2L	50 / Tube

CHARACTERISTICS CURVES

($T_A = 25^\circ\text{C}$ unless otherwise noted)

Fig.1 Typical Forward Characteristics

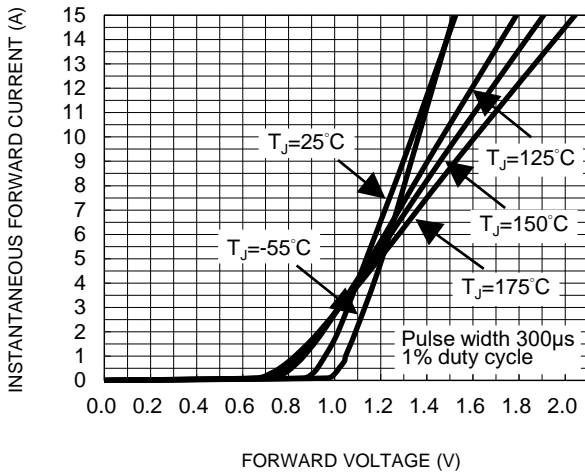

Fig.2 Typical Reverse Characteristics

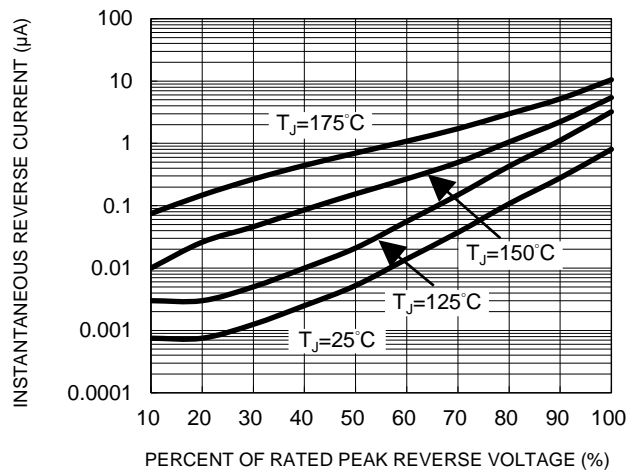

Fig.3 Peak forward current versus case temperature

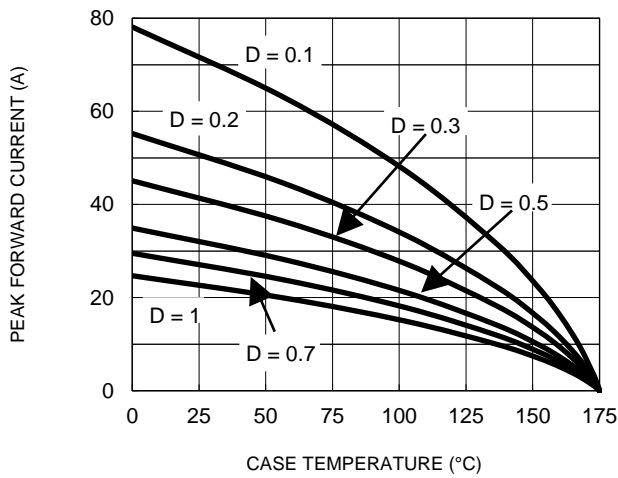

Fig.4 Typical Junction Capacitance

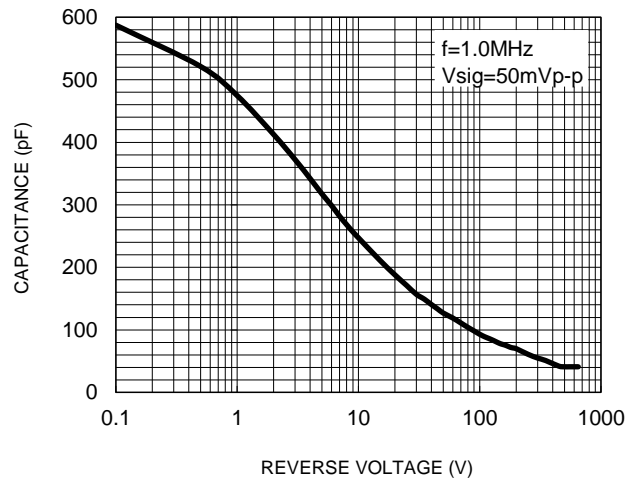

Fig.5 Typical Capacitive Charge

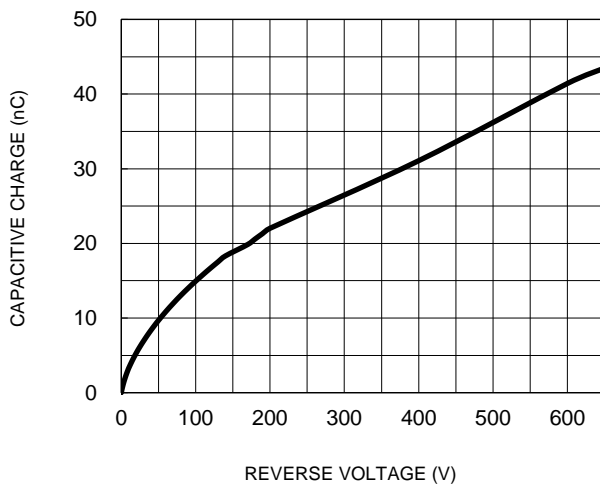
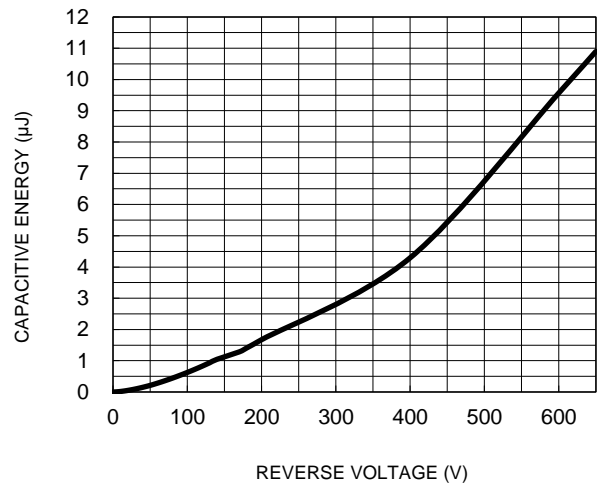

FIG.6 Typical Capacitance Stored Energy



CHARACTERISTICS CURVES

(T_A = 25°C unless otherwise noted)

Fig.7 Typical Transient Thermal Characteristics

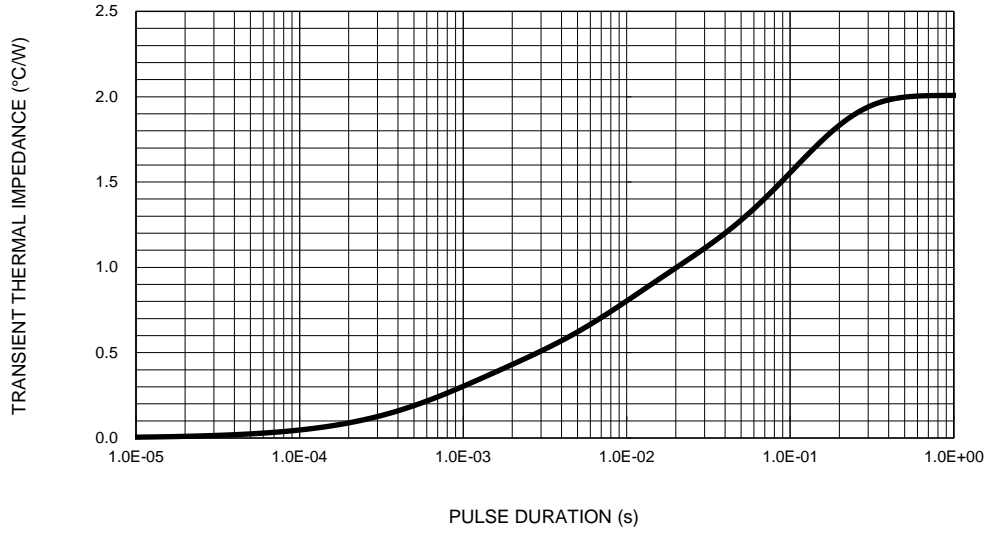

PACKAGE OUTLINE DIMENSIONS

ITO-220AC-2L

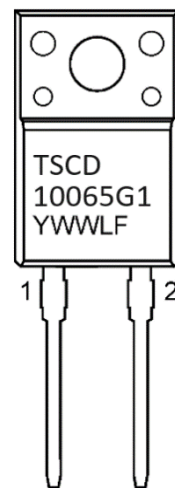
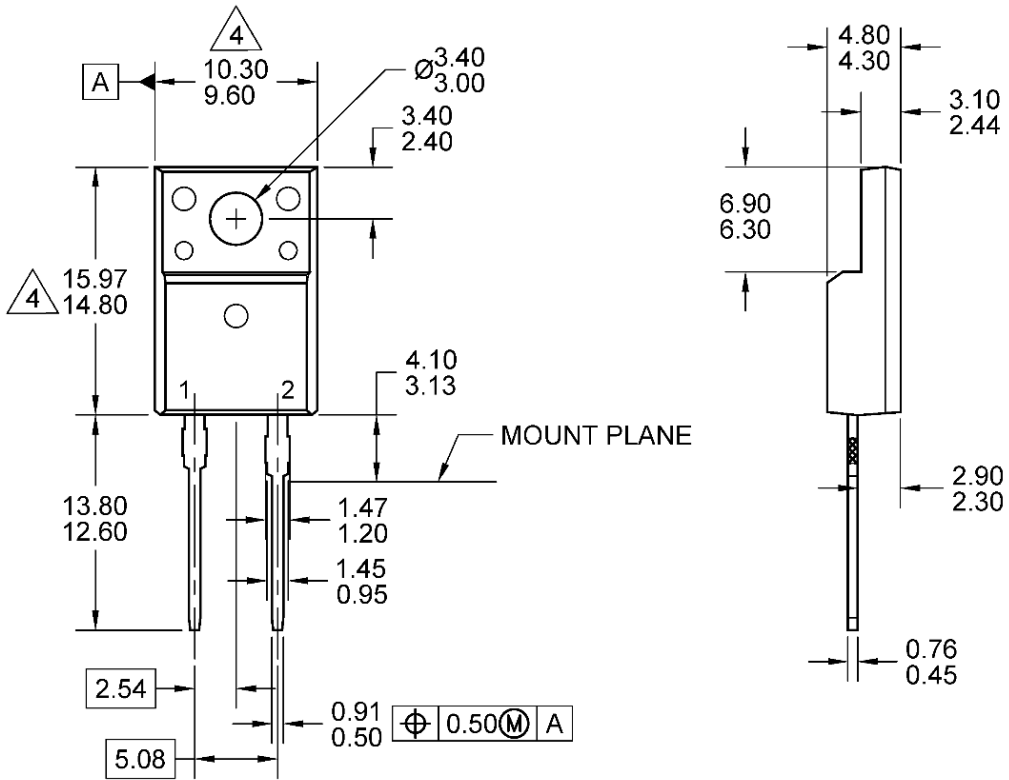

NOTES: UNLESS OTHERWISE SPECIFIED

1. ALL DIMENSIONS ARE IN MILLIMETERS.
2. DIMENSIONING AND TOLERANCING PER ASME Y14.5M-1994.
3. PACKAGE OUTLINE REFERENCE: EIAJ ED-7500A-1, SC-91.

4 THIS DO NOT INCLUDE MOLD FLASH. THESE DIMENSIONS ARE MEASURED AT THE OUTERMOST EXTREME OF THE PLASTIC BODY.

5. DWG NO. REF: HQ2SD07-ITO220ACSiC-120 REV A.

MARKING DIAGRAM

- Y** = YEAR CODE
- WW** = WEEK CODE (01~52)
- L** = LOT CODE (1~9, A~Z)
- F** = FACTORY CODE

Notice

Specifications of the products displayed herein are subject to change without notice. TSC or anyone on its behalf assumes no responsibility or liability for any errors or inaccuracies.

Purchasers are solely responsible for the choice, selection, and use of TSC products and TSC assumes no liability for application assistance or the design of Purchasers' products.

Information contained herein is intended to provide a product description only. No license, express or implied, to any intellectual property rights is granted by this document. Except as provided in TSC's terms and conditions of sale for such products, TSC assumes no liability whatsoever, and disclaims any express or implied warranty, relating to sale and/or use of TSC products including liability or warranties relating to fitness for a particular purpose, merchantability, or infringement of any patent, copyright, or other intellectual property right.

The products shown herein are not designed for use in medical, life-saving, or life-sustaining applications. Customers using or selling these products for use in such applications do so at their own risk and agree to fully indemnify TSC for any damages resulting from such improper use or sale.