

## N-Channel Power MOSFET

600V, 1.2A, 10Ω

### FEATURES

- Low RDS(ON) 9.4Ω (Typ.)
- Low gate charge typical @ 7.7nC (Typ.)
- Low Crss typical @ 8pF (Typ.)
- RoHS Compliant
- Halogen-free

### APPLICATIONS

- Power Supply
- Lighting
- Charger

KEY PERFORMANCE PARAMETERS		
PARAMETER	VALUE	UNIT
V <sub>DS</sub>	600	V
R <sub>DS(on)</sub> (max)	10	Ω
Q <sub>g</sub>	7.7	nC



TO-252 (DPAK)

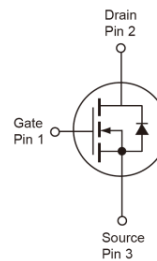
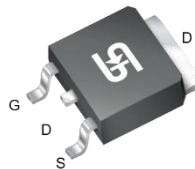

Note: MSL 3 (Moisture Sensitivity Level) per J-STD-020

ABSOLUTE MAXIMUM RATINGS (T <sub>A</sub> = 25°C unless otherwise noted)			
PARAMETER	SYMBOL	LIMIT	UNIT
Drain-Source Voltage	V <sub>DS</sub>	600	V
Gate-Source Voltage	V <sub>GS</sub>	±30	V
Continuous Drain Current	I <sub>D</sub>	1.2	A
T <sub>C</sub> = 25°C			
Pulsed Drain Current (Note 1)	I <sub>DM</sub>	4.8	A
Total Power Dissipation @ T <sub>C</sub> = 25°C	P <sub>D</sub>	35	W
Single Pulse Avalanche Energy (Note 2)	E <sub>AS</sub>	20	mJ
Single Pulse Avalanche Current (Note 2)	I <sub>AS</sub>	1.4	A
Operating Junction and Storage Temperature Range	T <sub>J</sub> , T <sub>STG</sub>	- 55 to +150	°C

THERMAL PERFORMANCE			
PARAMETER	SYMBOL	LIMIT	UNIT
Junction to Case Thermal Resistance	R <sub>θJC</sub>	3.6	°C/W
Junction to Ambient Thermal Resistance (Note 3)	R <sub>θJA</sub>	62	°C/W

**Notes:**

1. Pulse Width ≤ 100μs.
2. L = 20mH, VGS = 10V, RG = 25Ω, Starting T<sub>J</sub> = 25°C.
3. Device on a PCB FR4 with 1 in<sup>2</sup> (single layer, 2 oz thick) copper area for drain connection.

<b>ELECTRICAL SPECIFICATIONS</b> ( $T_A = 25^\circ\text{C}$ unless otherwise noted)						
PARAMETER	CONDITIONS	SYMBOL	MIN	TYP	MAX	UNIT
<b>Static</b> (Note 4)						
Drain-Source Breakdown Voltage	$V_{GS} = 0V, I_D = 250\mu A$	$BV_{DSS}$	600	--	--	V
Gate Threshold Voltage	$V_{DS} = V_{GS}, I_D = 250\mu A$	$V_{GS(TH)}$	2.5	3.1	4.5	V
Gate Body Leakage	$V_{GS} = \pm 30V, V_{DS} = 0V$	$I_{GSS}$	--	--	$\pm 100$	nA
Zero Gate Voltage Drain Current	$V_{DS} = 600V, V_{GS} = 0V$	$I_{DSS}$	--	--	10	$\mu A$
Drain-Source On-State Resistance	$V_{GS} = 10V, I_D = 0.6A$	$R_{DS(on)}$	--	9.4	10	$\Omega$
Forward Transconductance	$V_{DS} = 10V, I_D = 0.6A$	$g_{fs}$	--	1.5	--	S
<b>Dynamic</b> (Note 5)						
Total Gate Charge	$V_{DS} = 480V, I_D = 0.29A,$ $V_{GS} = 10V$	$Q_g$	--	7.7	--	nC
Gate-Source Charge		$Q_{gs}$	--	1	--	
Gate-Drain Charge		$Q_{gd}$	--	4.6	--	
Input Capacitance	$V_{DS} = 300V, V_{GS} = 0V,$ $f = 1.0\text{MHz}$	$C_{iss}$	--	150	--	pF
Output Capacitance		$C_{oss}$	--	11	--	
Reverse Transfer Capacitance		$C_{rss}$	--	8	--	
Gate Resistance	$f = 1.0\text{MHz}$	$R_g$	--	4.1	--	$\Omega$
<b>Switching</b> (Note 6)						
Turn-On Delay Time	$V_{DD} = 300V, R_G = 3.3\Omega,$ $I_D = 0.29A, V_{GS} = 10V$	$t_{d(on)}$	--	4.5	--	ns
Turn-On Rise Time		$t_r$	--	3.7	--	
Turn-Off Delay Time		$t_{d(off)}$	--	13	--	
Turn-Off Fall Time		$t_f$	--	64	--	
<b>Source-Drain Diode</b>						
Body-Diode Continuous Forward Current		$I_S$	--	--	1.2	A
Body-Diode Pulsed Current (Note 1)		$I_{SM}$	--	--	4.8	A
Forward Voltage (Note 4)	$I_S = 0.6A, V_{GS} = 0V$	$V_{SD}$	--	0.8	1.4	V

**Notes:**

- Pulse test: Pulse Width  $\leq 300\mu s$ , duty cycle  $\leq 2\%$ .
- Defined by design. Not subject to production test.
- Switching time is essentially independent of operating temperature.

**ORDERING INFORMATION**

ORDERING CODE	PACKAGE	PACKING
TSM1NB60CP ROG	TO-252 (DPAK)	2,500pcs / 13" Reel

**CHARACTERISTICS CURVES**

( $T_c = 25^\circ\text{C}$  unless otherwise noted)

**Output Characteristics**

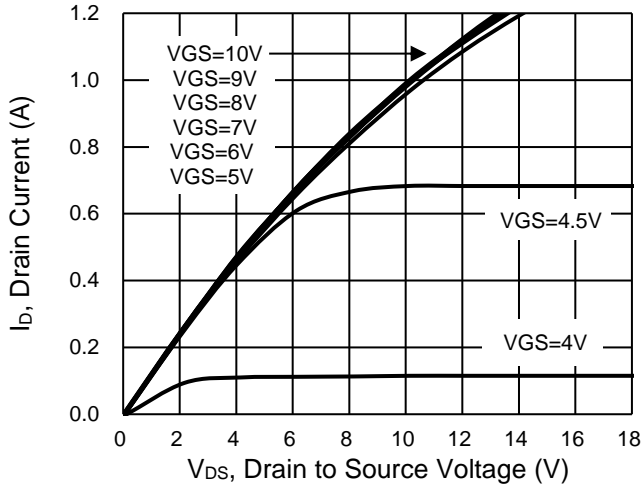

**Transfer Characteristics**

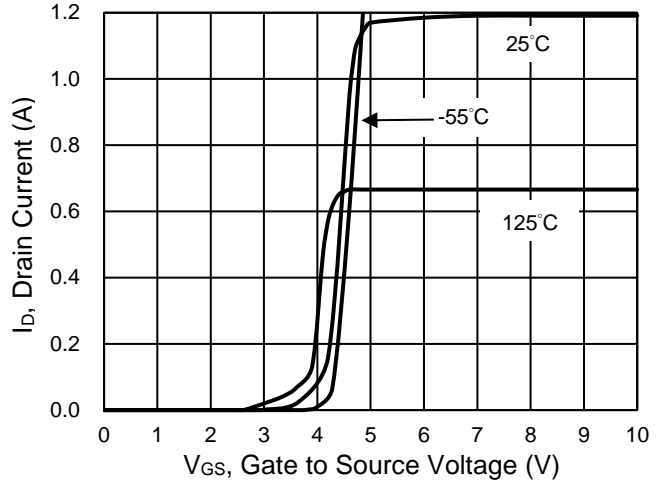

**On-Resistance vs. Drain Current**

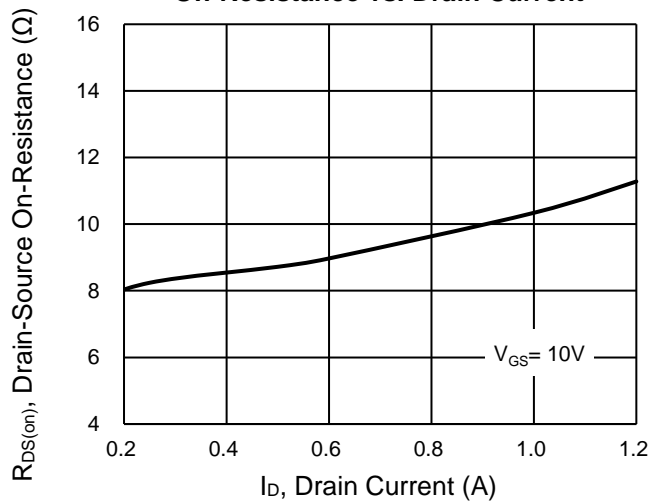

**Gate-Source Voltage vs. Gate Charge**

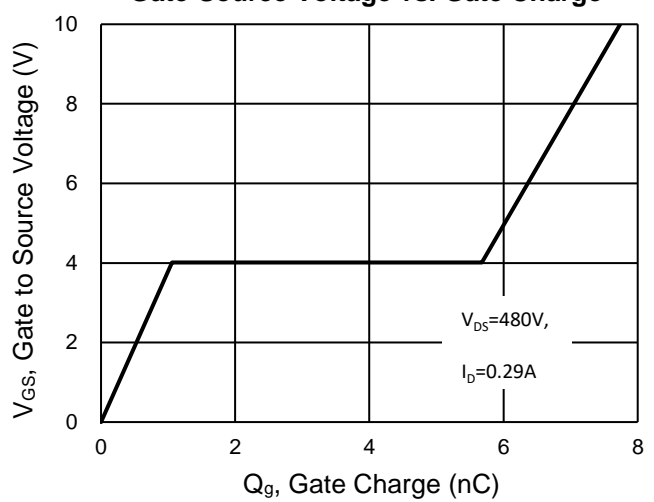

**On-Resistance vs. Junction Temperature**

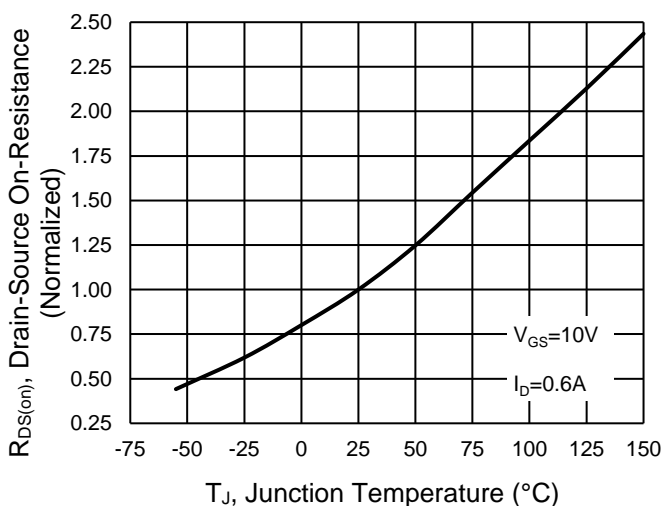

**On-Resistance vs. Gate-Source Voltage**

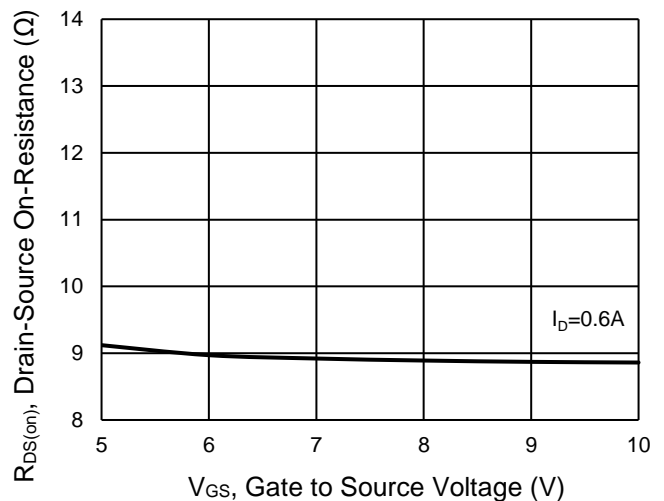

**CHARACTERISTICS CURVES**

( $T_c = 25^\circ\text{C}$  unless otherwise noted)

**Capacitance vs. Drain-Source Voltage**

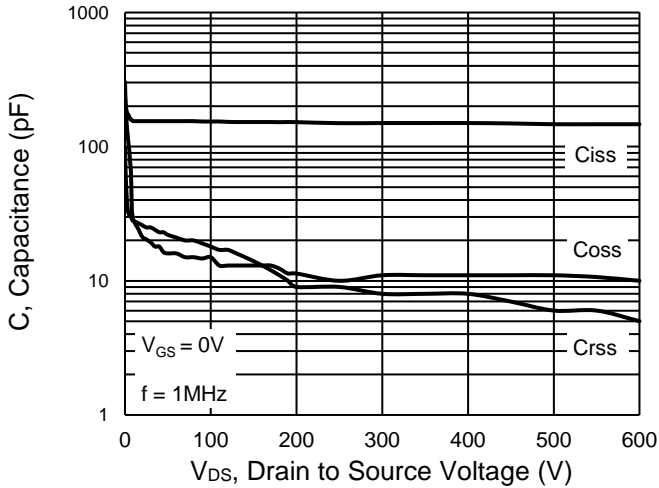

**BV<sub>DSS</sub> vs. Junction Temperature**

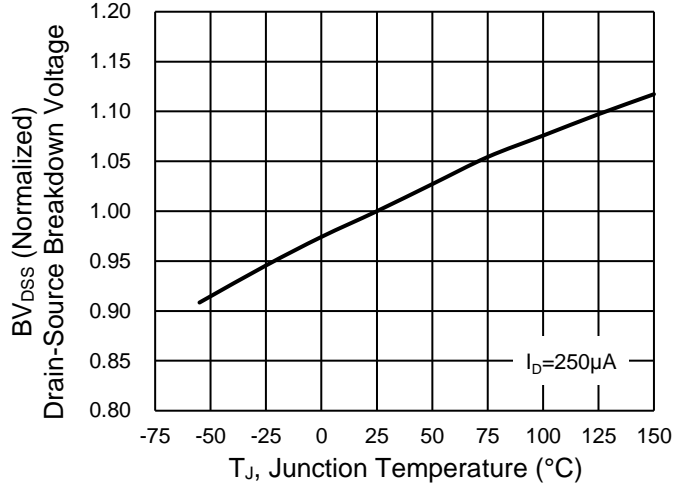

**Maximum Safe Operating Area, Junction-to-Case**

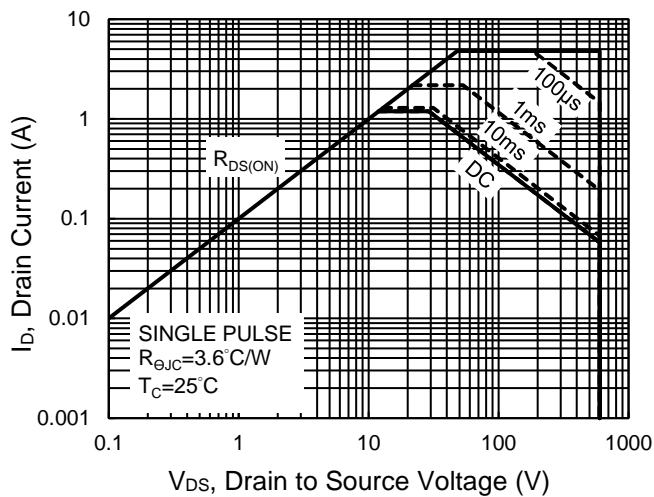

**Source-Drain Diode Forward Current vs. Voltage**

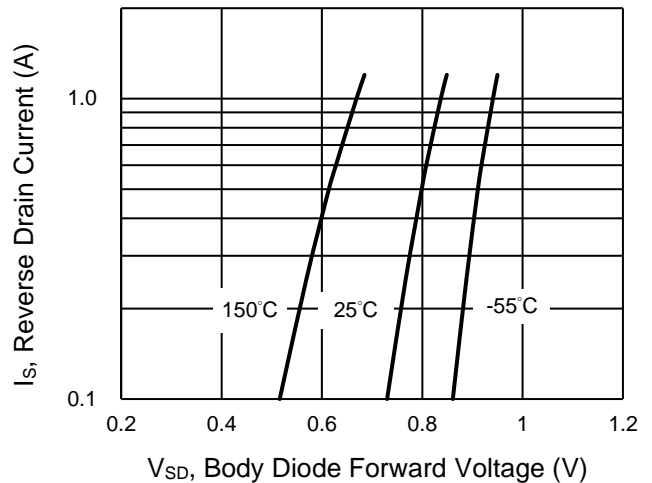

**Normalized Thermal Transient Impedance, Junction-to-Case**

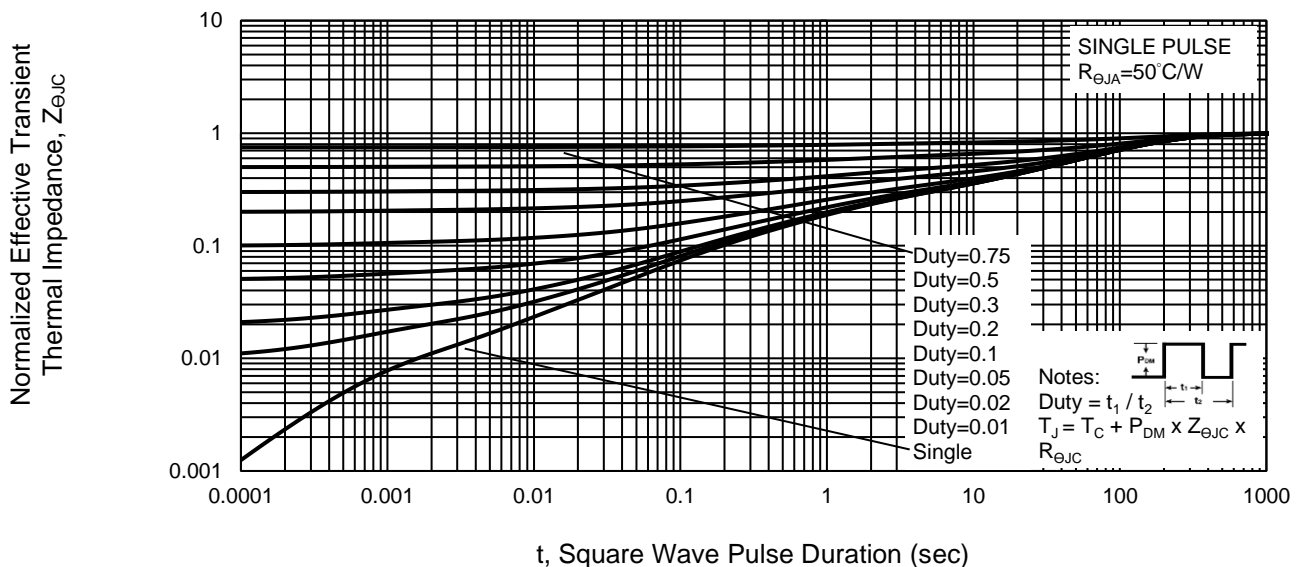

**CHARACTERISTICS CURVES**

( $T_c = 25^\circ\text{C}$  unless otherwise noted)

**Power Dissipation**

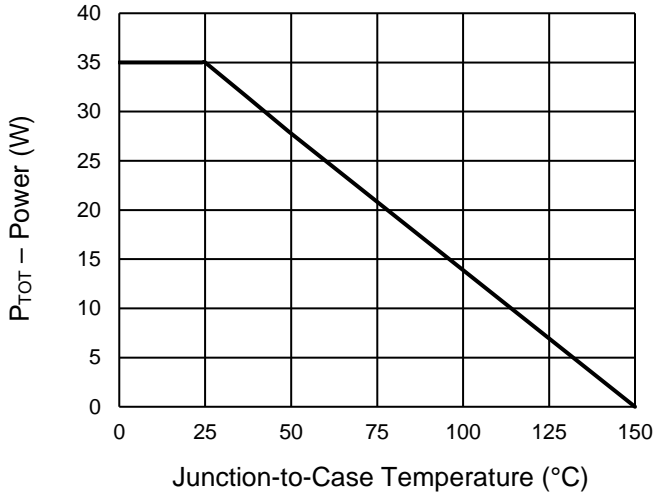

**Drain Current**

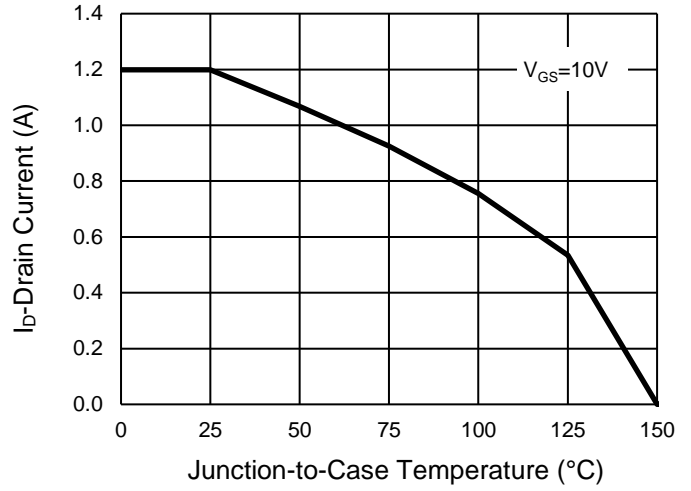

**Normalized gate threshold voltage vs Temperature**

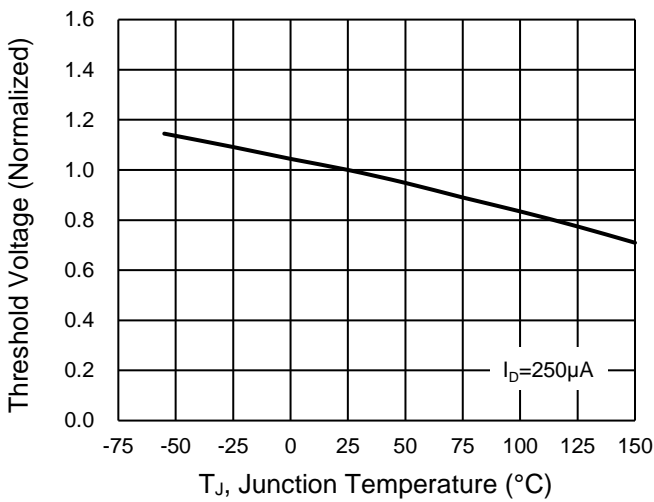

**PACKAGE OUTLINE DIMENSIONS** (Unit: Millimeters)

**TO-252 (DPAK)**

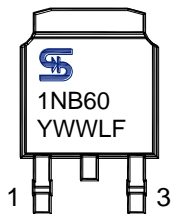
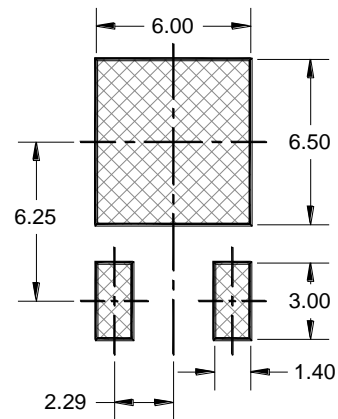
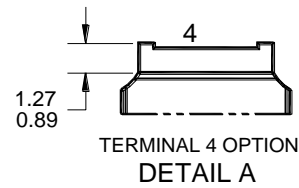
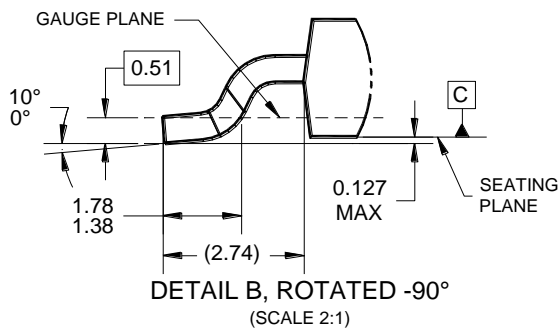
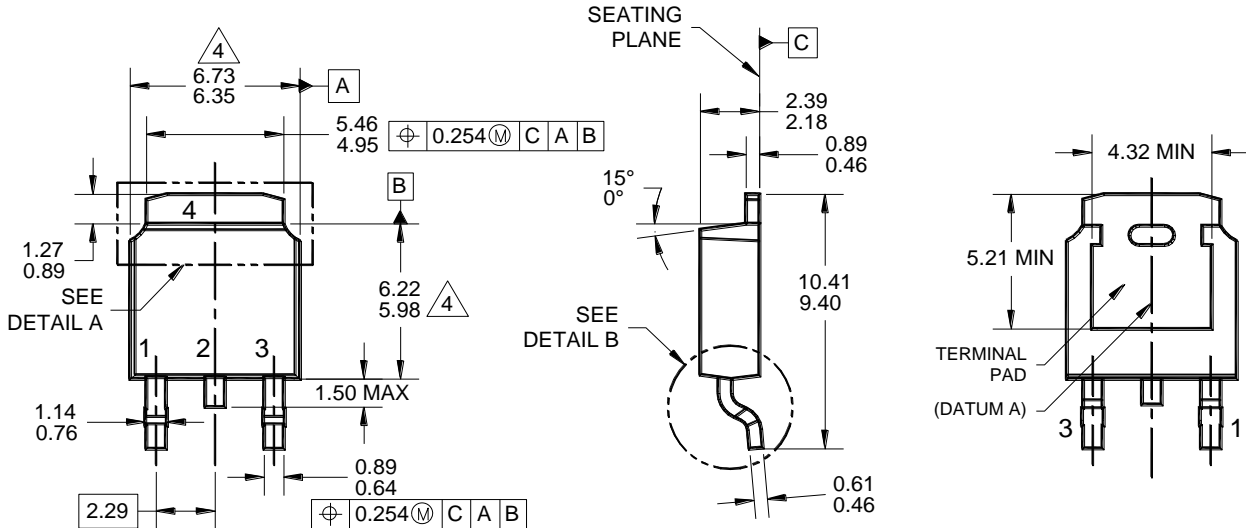

**MARKING DIAGRAM**

- P/N = MARKING CODE
- Y = YEAR CODE
- WW = WEEK CODE (01 ~ 52)
- L = LOT CODE (1~9, A~Z)
- F = FACTORY CODE

**NOTES: UNLESS OTHERWISE SPECIFIED**

1. ALL DIMENSIONS ARE IN MILLIMETERS.
2. DIMENSIONING AND TOLERANCING PER ASME Y14.5M-1994.
3. PACKAGE OUTLINE REFERENCE: JEDEC TO-252, VARIATION AA, ISSUE F.
4. MOLDED PLASTIC BODY DIMENSIONS DO NOT INCLUDE MOLD FLASH, PROTRUSION, OR GATE BURRS.
5. DWG NO. REF: HQ2SD07-TO252AA-013 REV B.

## **Notice**

Specifications of the products displayed herein are subject to change without notice. TSC or anyone on its behalf, assumes no responsibility or liability for any errors or inaccuracies.

Purchasers are solely responsible for the choice, selection, and use of TSC products and TSC assumes no liability for application assistance or the design of Purchasers' products.

Information contained herein is intended to provide a product description only. No license, express or implied, to any intellectual property rights is granted by this document. Except as provided in TSC's terms and conditions of sale for such products, TSC assumes no liability whatsoever, and disclaims any express or implied warranty, relating to sale and/or use of TSC products including liability or warranties relating to fitness for a particular purpose, merchantability, or infringement of any patent, copyright, or other intellectual property right.

The products shown herein are not designed for use in medical, life-saving, or life-sustaining applications. Customers using or selling these products for use in such applications do so at their own risk and agree to fully indemnify TSC for any damages resulting from such improper use or sale.