

COMPACT HIGH POWER RELAY

For automotive applications

1 POLE - 70A (For 12V Car Battery)

FBR59-HW Series

■ FEATURES

- 1 pole, 70A, 1 form U
- High temperature grade (-40°C to 125°C)
- Comparable capability with Power Mini ISO plug-in relays
- Through hole reflow type available
- RoHS compliant, lead free

Please see page 4 for more information

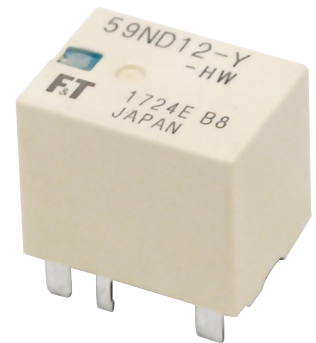

■ Part Numbers

[Example] FBR59 N D12 - Y - HW - RW
 (a) (b) (c) (d) (e) (f)

(a)	Relay type	FBR59 : FBR59 series
(b)	Enclosure	N : Plastic sealed type
(c)	Coil rated voltage	D12 : 9...12VDC Coil rating table at page 3
(d)	Contact material	Y : Silver-tin oxide
(e)	Contact rating	HW : 70A
(f)	Soldering	Nil : Standard
		RW : Through hole reflow (THR)

Actual markings does not carry the type name: "FBR"

E.g.: Ordering code: FBR59ND12-Y-HW Actual marking: 59ND12-Y-HW

FBR59-HW Series

■ Specifications

Item			FBR59-HW	Remarks / conditions
Contact data	Configuration		1 form U	
	Construction		Single	
	Material		Silver-tin oxide	
	Voltage drop		Max. 100 mV	At 1A, 12VDC
	Contact rating		70A, 14VDC 45A, 14VDC	Resistive load Motor load
	Max. carrying current		70A / 1h	At 25 deg C, rated load
	Max. inrush current		220A	Capacitor inrush based
	Min. switching load *		1A 6VDC	Reference
	Max. switching load **		70A, 14VDC 45A, 14VDC	Resistive load Motor load
Coil	Operating temperature range		-40°C ~ +125°C	No frost
Timing data	Operate		Max. 10ms	At nominal voltage (without diode, without bounce)
	Release		Max. 10ms	At nominal voltage (without diode, without bounce)
	Storage temperature / humidity		-40°C to 125°C, 45 to 85RH	No frost
Life	Mechanical		Min. 1 x 10 ⁶ operations	without contact load
	Electrical		Min. 50 x 10 ³ operations at 70A Min. 100 x 10 ³ operations at 60A	resistive load
Insulation	Insulation resistance		Min. 100MΩ at 500VDC	Initial
	Dielectric withstanding voltage	Open contacts	500VAC (50/60Hz), 1 minute	
		Coil contact	500VAC (50/60Hz), 1 minute	
Other	Vibration resistance	Misoperation	10 to 200Hz, 44m/s ² (4.5G), constant acceleration	
		Endurance	10 to 200Hz, 44m/s ² (4.5G), constant acceleration	
	Shock resistance	Misoperation	Min. 100m/s ² (11 ± 1ms)	
		Endurance	Min. 1,000m/s ² (6 ± 1ms)	
	Dimensions / weight		15.0 x 20.0 x 16.8 mm / approx. 13g	

* : Minimum switching loads mentioned above are reference values. Please perform the confirmation test with actual load before production since reference values may vary according to switching frequencies, environmental conditions and expected reliability levels.

** : Maximum switching loads mentioned above are reference values. Please refer to operation range graph for continuous current.

Note: Values of electrical characteristics are under 15 to 35°C, 25 to 75%RH (JIS standard condition) unless otherwise specified.

Note: Care shall be taken on the heat generated on PC board when maximum carrying current exceeds 10A.

Please perform the confirmation test with actual conditions.

FBR59-HW Series

■ Coil Data

code	Rated Coil Voltage (VDC)	Coil Resistance +/-10%(Ω)	Must Operate Voltage* (VDC)	Must Release Voltage* (VDC)
D09	9	170	5.4 (at 20°C) 7.7 (at 125°C)	0.7 (at 20°C) 1.0 (at 125°C)
D10	10	220	6.3 (at 20°C) 9 (at 125°C)	0.8 (at 20°C) 1.2 (at 125°C)
D12	12	320	7.3 (at 20°C) 10.4 (at 125°C)	1.0 (at 20°C) 1.5 (at 125°C)

Note: All values in the table are valid at 20°C and zero contact current, unless otherwise specified.

* : Specified operated values are valid for pulse wave voltage.

Note: Please use at rated coil voltage. Please refer to characteristic data and set up adequate voltage in case of use at over voltage.

■ Dimensions

- Dimensions

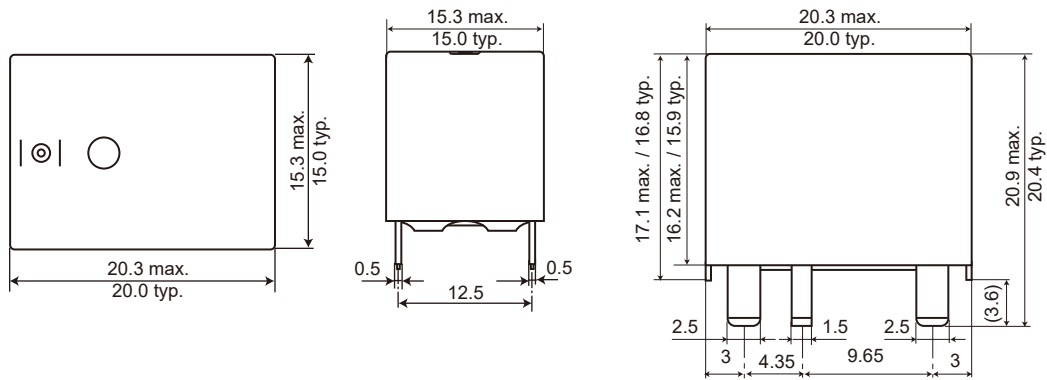

- Schematics
(BOTTOM VIEW)

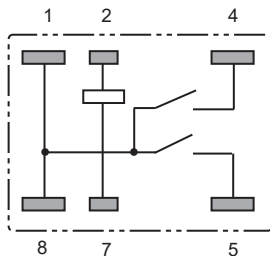

FBR59-HW Series

- PC Board Mounting Hole Layout (BOTTOM VIEW)

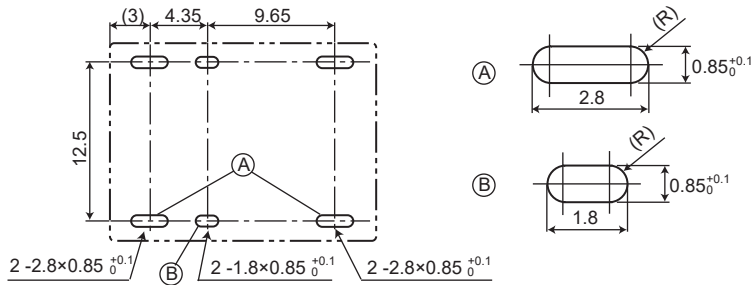

- * Dimensions of the terminals do not include thickness of pre-solder.
- * Tolerance of PC board mounting hole layout : ± 0.1 unless otherwise specified.

(): Reference value Unit: mm

Characteristic Data (Reference)

Distribution of operate/release voltage

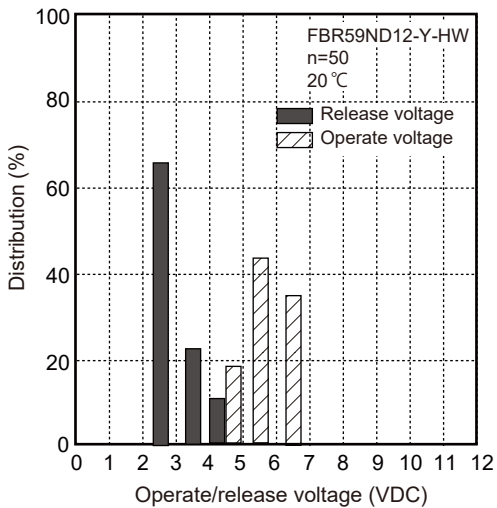

Distribution of contact resistance

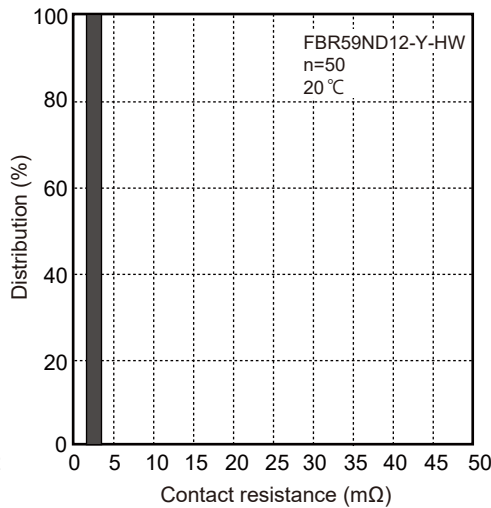

Distribution of operate/release time

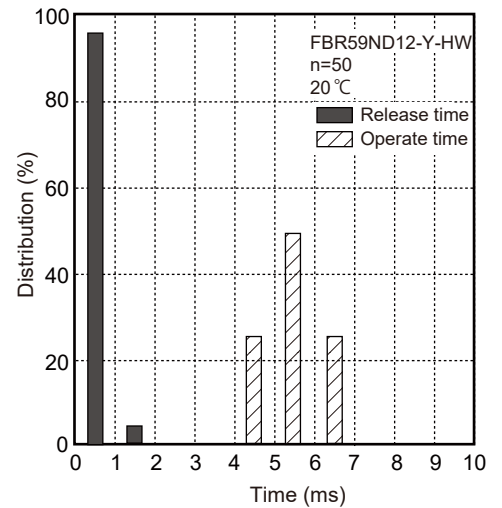

FBR59-HW Series

Operating range

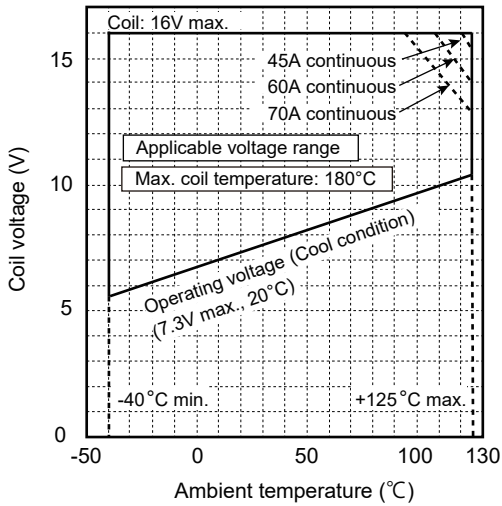

Contact current capacity

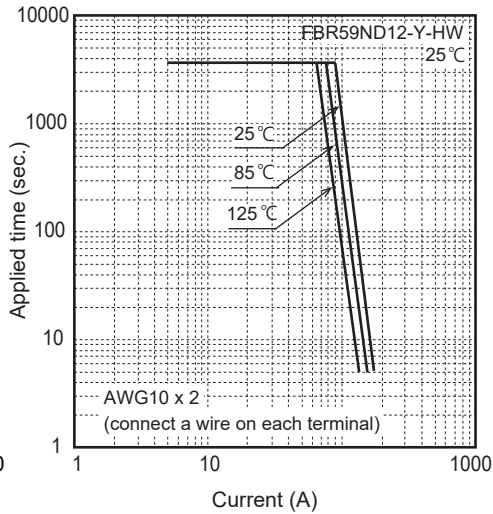

Coil temperature rise (ambient temperature 25°C)

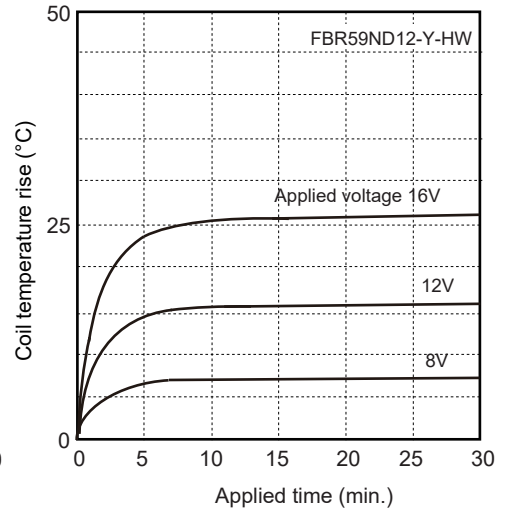

Coil temperature rise (ambient temperature 25°C)

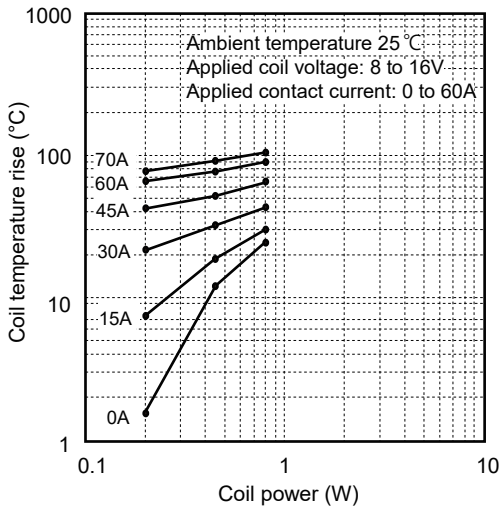

Coil temperature rise (ambient temperature 85°C)

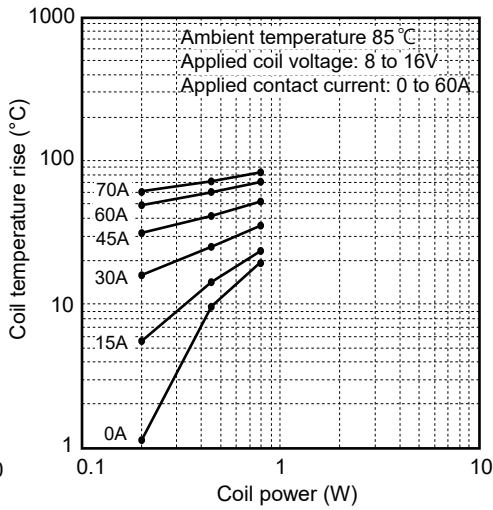

FBR59-HW Series

Shock resistance characteristics

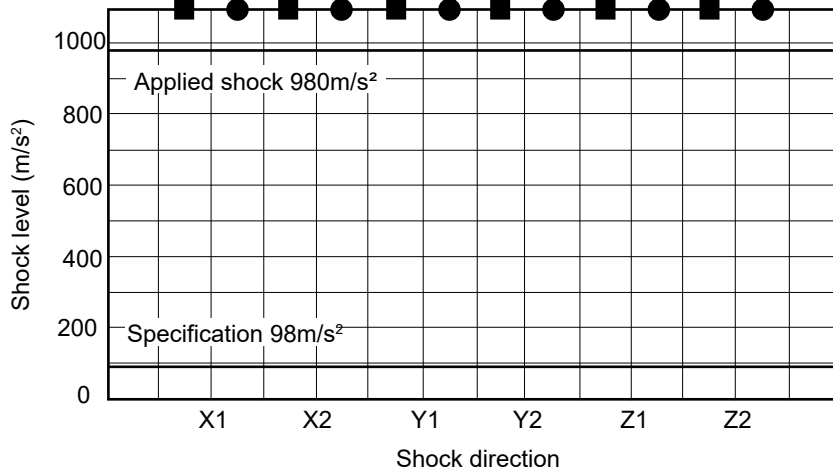

Shock application time: 6 ± 1 ms half-sine wave
 Test conditions: Coil energized(12VDC) and de-energized
 Shock direction: see diagram below
 Detection level: chatter > 1 ms

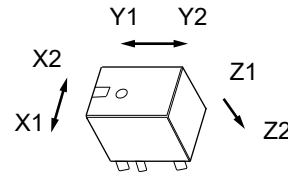

■ Make contact (coil de-energized)
 ● Make contact (coil energized)

Vibration resistance characteristics

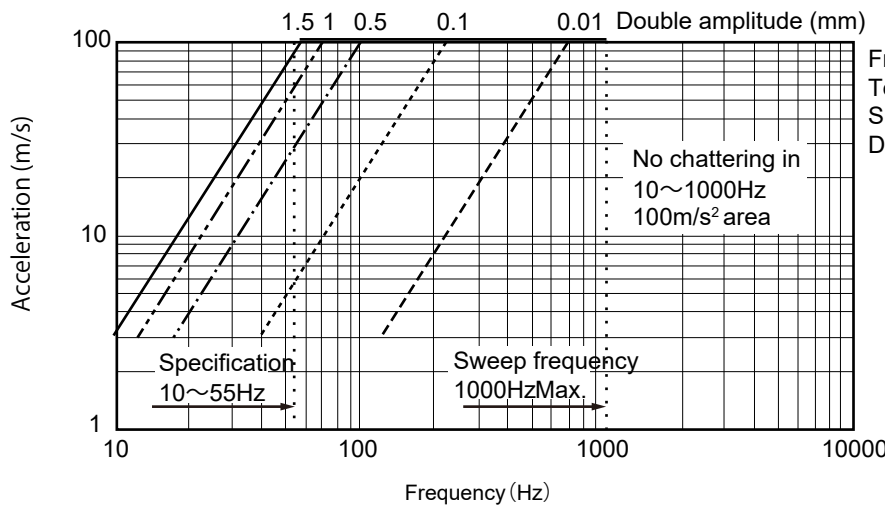

Frequency : 10 to 1000Hz
 Test conditions: Coil energized(12VDC) and de-energized
 Shock direction: see diagram below
 Detection level: chatter > 1 ms

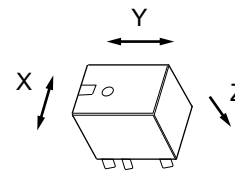

FBR59-HW Series

CAUTIONS

- All values mentioned in this datasheet are provided under ideal conditions. Please perform the confirmation test before actual use.
- Reflow soldering is prohibited for flow soldering type.
- Do not use relays in the atmosphere with sulfide gas, chloride gas or nitric oxide. Contact resistance may increase.
- Do not use silicon or silicon-containing product or materials near relays. It may cause contact failure.

GENERAL INFORMATION

1. ROHS Compliance

- All relays produced by Fujitsu Components are compliant with RoHS directive 2011/65/EU, including commission delegated directive 2015/863.

2. Recommended lead free solder condition

- Lead free solder plating on relay terminals is Sn-3.0Ag-0.5Cu, unless otherwise specified. This material has been verified to be compatible with PbSn assembly process.
- Recommended solder for assembly: Sn-3.0Ag-0.5Cu.

Flow Solder Condition:

Pre-Heating: maximum 120°C
within 90 sec.
Soldering: dip within 5 sec. at 255°C±5°C
solder bath
Relay must be cooled by air immediately after
soldering

Solder by Soldering Iron:

Soldering Iron: 30-60W
Temperature: maximum 340-360°C
Duration: maximum 3 sec.

Reflow Solder Condition:

(Applicable only for reflow capable type)
Recommended reflow soldering profile
IRS (infrared reflow soldering)

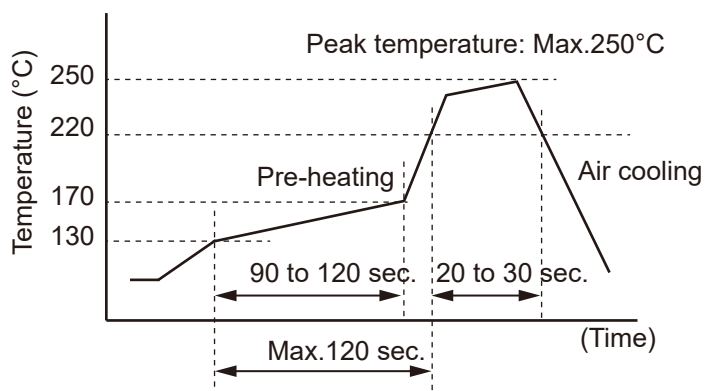

Important notes for reflow soldering

- Temperature shall be measured at PC board upper surface
- Temperature at PC board upper surface may be change of PC board, components mounted on the PC board and/ or heating method. Please perform the confirmation test with your actual PC board.
- This reflow solder condition is applicable only for reflow-capable relays. Do not reflow reflow-incapable relays.

We highly recommend that you confirm your actual solder conditions

3. Moisture Sensitivity

- Moisture Sensitivity Level standard is not applicable to electromechanical relays, unless otherwise indicated.

4. Tin Whiskers

- Dipped SnAgCu solder is known as presenting a low risk to tin whisker development. No considerable length whisker was found by our in house test.

FBR59-HW Series

Contact

Japan

FUJITSU COMPONENT LIMITED
Shinagawa Seaside Park Tower
12-4, Higashi-shinagawa 4-chome,
Tokyo 140 0002, Japan
Tel: +81-3-3450-1682
Email: fcl-contact@cs.fcl-components.com

North and South America

FUJITSU COMPONENTS AMERICA
2055 Gateway Place Suite 480,
San Jose, CA 95110 USA
Tel: +1-408-745-4900
Email: fcai.components@fcl-components.com

Europe

FUJITSU COMPONENTS EUROPE
Diamantlaan 25
2132 WV Hoofddorp, Netherlands
Tel: +31-23-556-0910
Email: info.fceu@cs.fcl-components.com

Asia Pacific

FUJITSU COMPONENTS ASIA.
No. 20 Harbour Drive, #07-01B
Singapore 117612
Tel: +65-6375-8560
Email: fcal@fcl-components.com

China

FUJITSU ELECTRONIC COMPONENTS
(SHANGHAI)
Unit 4306, InterContinental Business Center
100 Yu Tong Road, Shanghai 200070, China
Tel: +86-21-3253 0998
Email: fcsh@fcl-components.com

Hong Kong

FUJITSU COMPONENTS HONG KONG
Unit 2313, Seapower Tower, Concordia
Plaza, No.1 Science Museum Road,
TST, Kowloon, Hong Kong
Tel: +852-2881-8495
Email: fcal@fcl-components.com

Web: www.fcl.fujitsu.com/en/

© 2023 Fujitsu Component Limited. All rights reserved. All trademarks or registered trademarks are the property of their respective owners.

Fujitsu Products are intended for general use, including without limitation, in personal, household and office environments, in buildings and for ordinary use in the industry. Fujitsu Products are not intended to be used in applications where extremely high safety is required ("High Safety Required Applications"), such as, but not limited to, applications in nuclear facilities, in aircraft automatic flight control, in air traffic control, in mass transit system control, in missile launch system, in weapon systems, in medical equipment for life support or any application involving a direct serious risk of physical injury or death.

Please do not use Fujitsu Products without securing the sufficient safety and reliability required for the High Safety Required Applications. In addition, Fujitsu shall not be liable against the customer and/or any third party for any claims or damages arising in connection with the use of Fujitsu Products in the High Safety Required Applications.

Fujitsu warrants that its Products, if properly used and services, will conform to their specification and will be free from defects in material and workmanship for twelve months from delivery.

The implied warranties of merchantability and fitness for a particular purpose and all other warranties, representations and conditions, express or implied by statute, trade usage or otherwise, except as set forth in this warranty, are excluded and shall not apply to the Products delivered.

The contents, data and information in this datasheet are provided by Fujitsu Component Ltd. as a service only to its user and only for general information purposes. The use of the contents, data and information provided in this datasheet is at the users' own risk.

Fujitsu has assembled this datasheet with care and will endeavor to keep the contents, data and information correct, accurate, comprehensive, complete and up to date.

Fujitsu Component Limited and affiliated companies do however not accept any responsibility or liability on their behalf, nor on behalf of its employees, for any loss or damage, direct, indirect or consequential, with respect to this datasheet, its contents, data, and information and related graphics and the correctness, reliability, accuracy, comprehensiveness, usefulness, availability and completeness thereof. Nor do Fujitsu Component Limited and affiliated companies accept on their behalf, nor on behalf of its employees, any responsibility or liability with respect to these datasheets, its contents, data, information and related graphics and the correctness, reliability, accuracy, comprehensiveness, usefulness, availability and completeness thereof. Rev. July 3, 2023.