

POWER RELAY

1 POLE – 20A Heavy Load

FTR-K3 Series

■ FEATURES

- SPST 20A and #250 tab terminal type is also available
- Low coil power (780mW)
- Glow wire compliant type available which satisfies GWT required for relay in IEC/EN 60335-1
- Cadmium free contacts
- SAFETY STANDARDS
UL, CSA, VDE,CQC approved
- Flux proof
- RoHS compliant



■ PARTNUMBER INFORMATION

[Example] $\frac{\text{FTR-K3}}{\text{(a)}} \frac{\text{A}}{\text{(b)}} \frac{\text{B}}{\text{(c)}} \frac{\text{012}}{\text{(d)}} \frac{\text{W}}{\text{(e)}} - \frac{\text{HC}}{\text{(f)}} - \frac{\text{GW}}{\text{(g)}}$

(a)	Relay type	FTR-K3	: FTR-K3 Series
(b)	Contact configuration	A J	: 1 form A (SPST-NO) (PCB terminal) : 1 form A (SPST-NO) (Tab terminal)
(c)	Coil type	B	: Standard type (780mW)
(d)	Coil rated voltage	012	: 5...48VDC See coil data chart
(e)	Contact material	W	: Silver alloy
(f)	Special type	Nil LS HC	: Standard type (20A) : High isolation type (20A) : High current type (25A)
(g)	Option	GW	: Comply with GWEPT (IEC/EN 60695-2-11) Not applicable for (b) J, (f) LS,

Actual marking does not carry the type name : "FTR"
E.g.: Ordering code: FTR-K3AB012W Actual marking: K3AB012W

FTR-K3 Series

■ SPECIFICATIONS

Item		FTR-K3	FTR-K3-LS	FTR-K3-HC	
Contact data	Configuration	1 form A			
	Construction	Single			
	Material	Silver alloy			
	Resistance (initial)	Max. 100mΩ at 1A, 6VDC			
	Contact rating (resistive)	20A, 250AC	20A, 250VAC	25A, 250VAC	
	Max. carrying current	25A			
	Max. inrush current	200A (peak) / steady 20A 100VAC (inverter load)			
	Max. switching current *1	25A			
	Max. switching voltage	250VAC			
	Max. switching power	6,250VA			
Min. switching load *2	100 mA, 5VDC				
Coil data	Rated power (20°C)	780 mW			
	Operate power (20°C)	380 mW			
	Operating temperature range	-40°C to +60°C (no frost)			
Timing data	Operate (at nominal voltage)	Max. 20ms (without bounce)			
	Release (at nominal voltage)	Max. 10ms (no diode, without bounce)			
Life	Mechanical	Min. 2 x 10 ⁶ operations			
	Electrical	Resistive load	Min. 100 x 10 ³ operations		
		Motor load	Min. 200 x 10 ³ operations (250VAC, inrush 80A cosφ=0.7, cut off 20A cosφ=0.9)	Min. 200 x 10 ³ operations (250VAC, inrush 80A cosφ=0.7 cut off 20A cosφ=0.9)	Min. 200 x 10 ³ operations (250VAC inrush 80A cosφ=0.7 cut off 25A cosφ=0.9)
		Inverter load	Min. 30 x 10 ³ operations 100VAC, inrush 200A / cut off 20A		
Insulation	Resistance (initial)	Min. 1,000MΩ at 500VDC			
	Dielectric strength	Open contacts	1,000VAC (50/60Hz) 1min		
		Contacts to coil	5,000VAC (50/60Hz) 1min		
	Surge strength	Coil to contacts	8,500V / 1.2 x 50μs standard wave		
	Clearance / creepage	6.4mm / 9.5mm	8.0mm / 9.5mm	6.4mm / 9.5mm	
Others	Vibration resistance	Misoperation > 1μs	10 to 55 to 10Hz single amplitude 0.75mm		
		Endurance	10 to 55 to 10Hz single amplitude 0.75mm		
	Shock	Misoperation > 1μs	Min. 200m/s ² (11 ± 1ms)		
		Endurance	Min. 1,000m/s ² (6 ± 1ms)		
	Weight	Approximately 25g			
	Sealing	Flux proof, RTII			

* 1 Need to consider the heat from PCB when max. current is more than 10A

* 2 Minimum switching loads mentioned above are reference values. Please perform the test with actual load before production since reference values may vary according to switching frequencies, environmental conditions and expected reliability levels..

FTR-K3 Series

■ COIL DATA

Coil Code	Rated Coil Voltage (VDC)	Coil Resistance $\pm 10\%$ (Ω)	Must Operate Voltage* (VDC)	Must Release Voltage* (VDC)	Rated Power (mW)
005	5	32	3.5	0.5	780
006	6	46	4.2	0.6	
009	9	105	6.3	0.9	
012	12	185	8.4	1.2	
018	18	415	12.6	1.8	
024	24	740	16.8	2.4	
048	48	2,955	33.6	4.8	

Note: All values in the table are valid for 20°C and zero contact current.

* Specified operate values are valid for pulse wave voltage.

Please use at rated coil voltage. Please refer to characteristic data and set up adequate voltage in case of use at over voltage.

■ SAFETY STANDARDS

Type	Compliance	Contact rating		
		FTR-K3	FTR-K3-LS	FTR-K3-HC
UL	UL 508 No. E63614	20A, 277VAC (resistive at 60°C) 1hp, 125VAC (at 60°C) 2hp, 277VAC (100,000 ops. at 60°C)		25A, 277VAC (resistive at 60°C) 1hp, 125VAC (at 60°C) 2hp, 277VAC (100,000 ops. at 60°C)
CSA	C22.2 No. 14 No. LR40304	20A, 277VAC (resistive) 1hp, 125VAC 2hp, 277VAC (100,000 ops.)	—	25A, 277VAC (resistive) 1hp, 125VAC 2hp, 277VAC (100,000 ops.)
VDE	IEC61810-1 EN60950-1 clause 2.9.2; 2.10.3; 2.10.5; 5.2 (only -LS)	20A, 250VAC (cos $\phi=1$) 60°C		25A, 250VAC (cos $\phi=1$) 60°C
CQC	GB15092-1 GB8898 GB/T21711.1 No. 17002165723	20A, 250VAC	—	25A, 250VAC
TUV	IEC61810-1	—	20A, 250VAC (cos $\phi=1$) 60°C	—

FTR-K3 Series

■ DIMENSIONS

FTR-K3AB type

● Dimensions

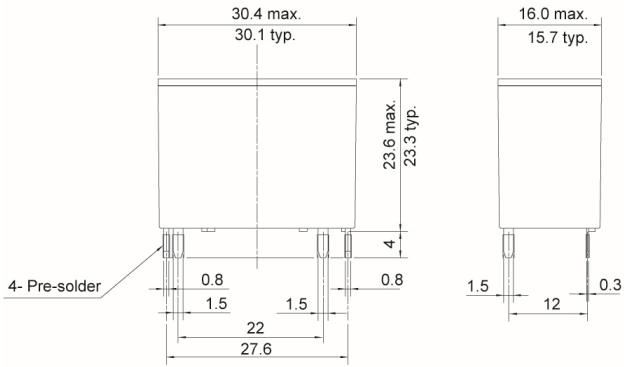

● Schematics (FTR-K3AB type)

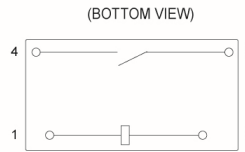

● PC board mounting hole layout

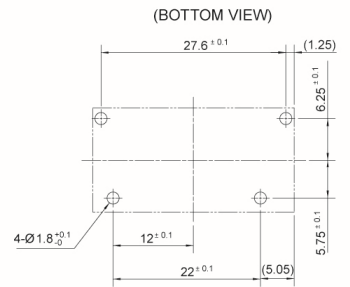

FTR-K3JB type

● Dimensions

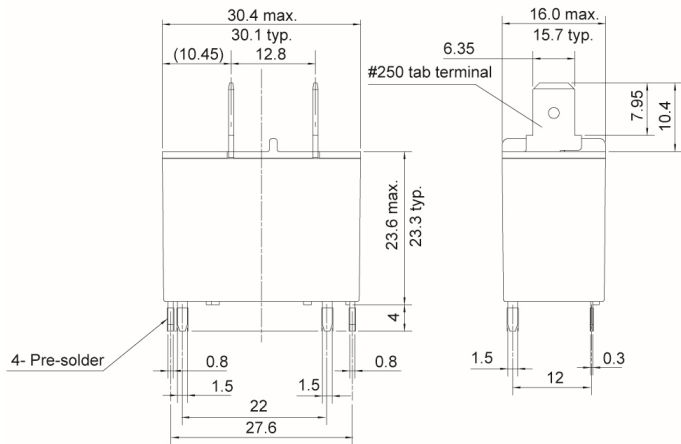

● Schematics (FTR-K3JB type)

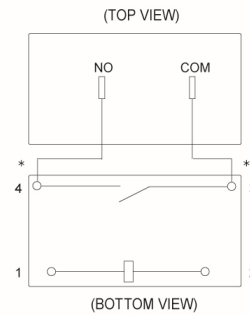

* : Contact terminal and tab terminal are connected inside the relay

● PC board mounting hole layout

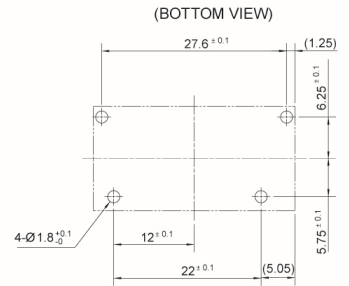

Notes:

- Dimensions of the terminals do not include thickness of pre-solder.
- Dimensions do not include tolerance.
- Tolerance of PC board mounting hole layout : ± 0.1 unless otherwise specified.

Unit:mm
(): Reference

FTR-K3 Series

■ CHARACTERISTIC DATA

(Characteristic data is not guaranteed value but measured values of samples from production line.)

■ FTR-K3 / FTR-K3-LS / FTR-K3-HC

Coil temperature rise

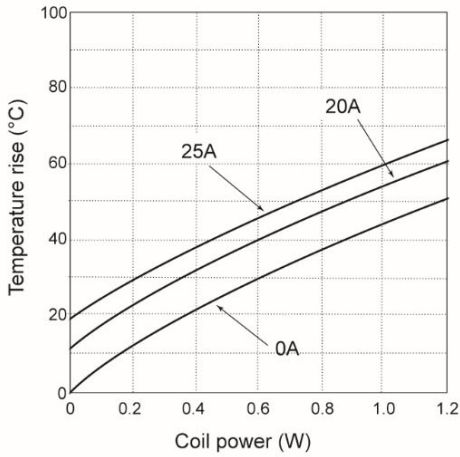

Operating range

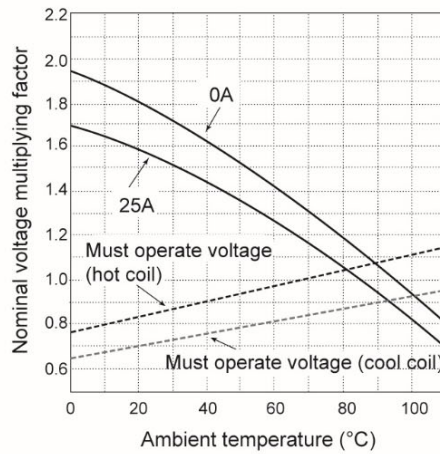

Maximum switching power

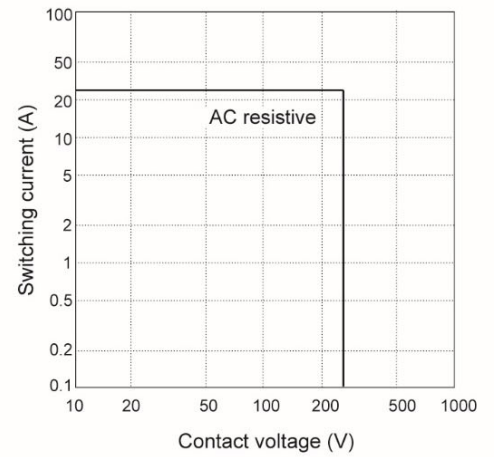

■ FTR-K3 / FTR-K3-LS

Life curve

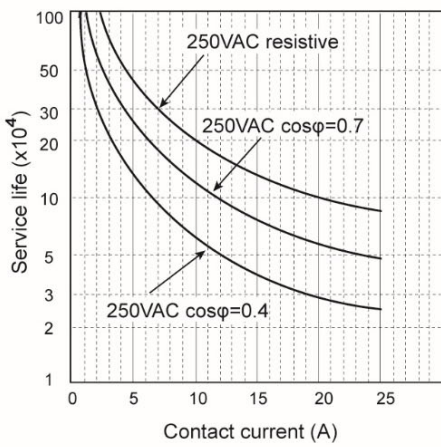

Electrical life test (resistive)

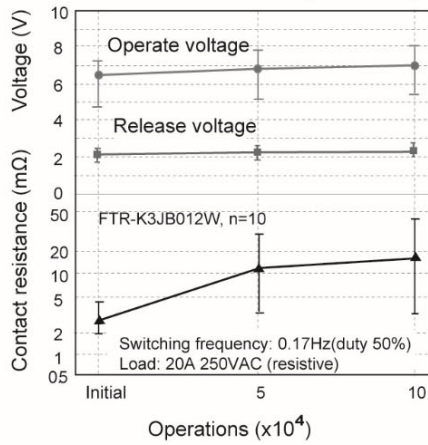

Electrical life test (motor load)

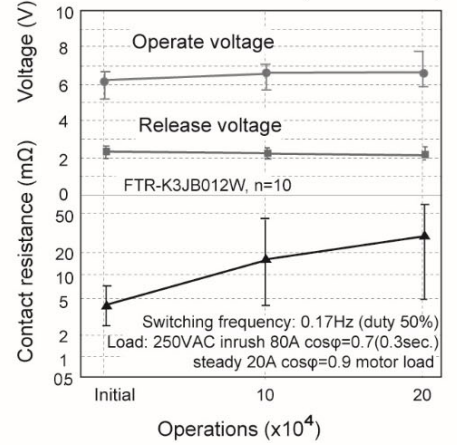

Electrical life test (inverter load)

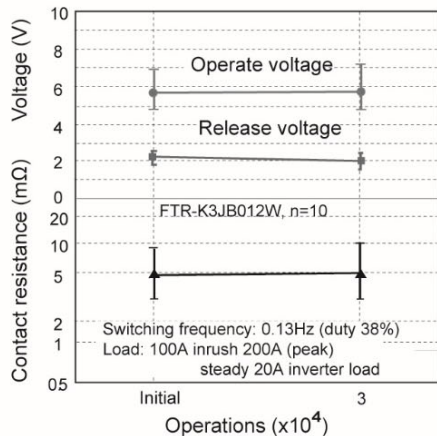

FTR-K3 Series

■ CHARACTERISTIC DATA

(Characteristic data is not guaranteed value but measured values of samples from production line.)

■ FTR-K3-HC

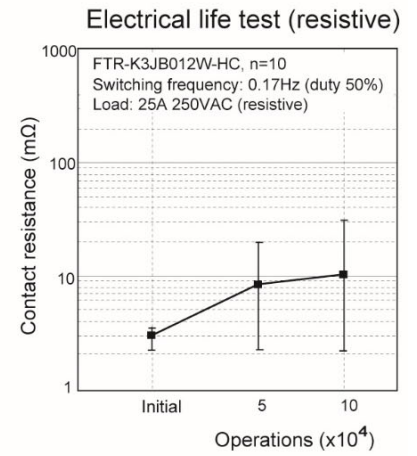
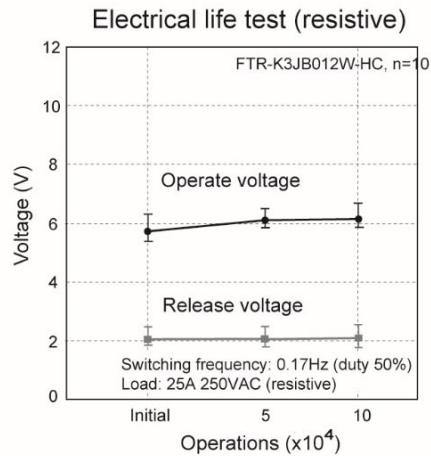
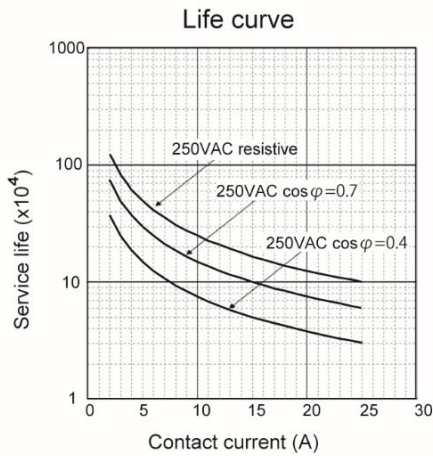

FTR-K3 Series

CAUTIONS

- All values mentioned in this datasheet are provided under ideal conditions. Please perform the confirmation test before actual use.
- Reflow soldering is prohibited.
- Do not use relays in the atmosphere with sulfide gas, chloride gas or nitric oxide. Contact resistance may increase.
- Do not use silicon or silicon-containing product or materials near relays. It may cause contact failure.

GENERAL INFORMATION

1. RoHS Compliance

- All relays produced by FCL Components are compliant with RoHS directive 2011/65/EU, including commission delegated directive 2015/863.

2. Recommended lead free solder condition

- Lead free solder plating on relay terminals is Sn-3.0Ag-0.5Cu, unless otherwise specified. This material has been verified to be compatible with PbSn assembly process.
- Recommended solder for assembly: Sn-3.0Ag-0.5Cu.

Flow Solder Condition:

Pre-Heating: Maximum 120°C within 90 sec.

Soldering: Dip within 5 sec. at 255°C±5°C solder bath

Relay must be cooled by air immediately after soldering

Solder by Soldering Iron:

Soldering Iron: 30-60W

Temperature: Maximum 340-360°C

Duration: Maximum 3 sec.

We highly recommend that you confirm your actual solder conditions

3. Moisture Sensitivity

- Moisture Sensitivity Level standard is not applicable to electromechanical relays, unless otherwise indicated.

4. Tin Whiskers

- Dipped SnAgCu solder is known as presenting a low risk to tin whisker development. No considerable length whisker was found by our in house test.

Contact

Japan

FCL COMPONENTS LIMITED
Shinagawa Seaside Park Tower
12-4, Higashi-shinagawa 4-chome,
Tokyo 140 0002, Japan
Tel: +81-3-3450-1682
Email: fcl-contact@cs.fcl-components.com

North and South America

FCL COMPONENTS AMERICA, INC.
2055 Gateway Place Suite 480,
San Jose, CA 95110 USA
Tel: +1-408-745-4900
Email: fcai.components@fcl-components.com

Europe

FCL COMPONENTS EUROPE B.V.
Diamantlaan 25
2132 WV Hoofddorp, Netherlands
Tel: +31-23-556-0910
Email: info.fceu@cs.fcl-components.com

Asia Pacific

FCL COMPONENTS ASIA PTE LTD.
No. 20 Harbour Drive, #07-01B
Singapore 117612
Tel: +65-6375-8560
Email: fcalf@fcl-components.com

China

FCL COMPONENTS (SHANGHAI) CO., LTD.
Unit 1105, Central Park - Jing An,
No.329 Heng Feng Road, Shanghai 200070,
China
Tel: +86-21-3253 0998
Email: fcsh@fcl-components.com

Web: www.fcl-components.com/en/

© 2024 FCL Components Limited. All rights reserved. All trademarks or registered trademarks are the property of their respective owners.

FCL Products are intended for general use, including without limitation, in personal, household and office environments, in buildings and for ordinary use in the industry. FCL Products are not intended to be used in applications where extremely high safety is required ("High Safety Required Applications"), such as, but not limited to, applications in nuclear facilities, in aircraft automatic flight control, in air traffic control, in mass transit system control, in missile launch system, in weapon systems, in medical equipment for life support or any application involving a direct serious risk of physical injury or death.

Please do not use FCL Products without securing the sufficient safety and reliability required for the High Safety Required Applications. In addition, FCL shall not be liable against the customer and/or any third party for any claims or damages arising in connection with the use of FCL Products in the High Safety Required Applications.

FCL warrants that its Products, if properly used and services, will conform to their specification and will be free from defects in material and workmanship for twelve months from delivery.

The implied warranties of merchantability and fitness for a particular purpose and all other warranties, representations and conditions, express or implied by statute, trade usage or otherwise, except as set forth in this warranty, are excluded and shall not apply to the Products delivered.

The contents, data and information in this datasheet are provided by FCL Components Limited as a service only to its user and only for general information purposes. The use of the contents, data and information provided in this datasheet is at the users' own risk.

FCL has assembled this datasheet with care and will endeavor to keep the contents, data and information correct, accurate, comprehensive, complete and up to date.

FCL Components Limited and affiliated companies do however not accept any responsibility or liability on their behalf, nor on behalf of its employees, for any loss or damage, direct, indirect or consequential, with respect to this datasheet, its contents, data, and information and related graphics and the correctness, reliability, accuracy, comprehensiveness, usefulness, availability and completeness thereof.

Nor do FCL Components Limited and affiliated companies accept on their behalf, nor on behalf of its employees, any responsibility or liability with respect to these datasheets, its contents, data, information and related graphics and the correctness, reliability, accuracy, comprehensiveness, usefulness, availability and completeness thereof. Rev. February 1, 2024.
