



Steckzungen für gedruckte Schaltungen

Masse im Steckbereich
 DIN 46342 Teil 1

Languettes plates pour circuits imprimés

Dimensions zone d'emboîtement selon
 DIN 46342 partie 1

Mounting tabs for printed circuitry

Dimensions in the tab sector
 DIN 46342 part 1

Werkstoff :

BZ = Bronze
 MS = Messing
 NS = Neusilber

Oberflächenbehandlung: Code

bl = blank (0)
 ag = versilbert (1)
 au = vergoldet (2)
 sn = verzinkt (8)

Bestellbeispiel:
Exemple de commande:
Example of order:

3866P.68 lose / en vrac / in bulk
 (3866P MS sn)

magaziniert / emmagasiné / wired

3866P.68
 (03866P MS sn)

Matière:

BZ = bronze
 MS = laiton
 NS = maillechort

Traitements de surface: Code

bl = brut (0)
 ag = argenté (1)
 au = doré (2)
 sn = étamé (8)

Material:

BZ = bronze
 MS = brass
 NS = german silver

Surface-plating: Code

bl = clean (0)
 ag = silver-plated (1)
 au = gold-plated (2)
 sn = tin-plated (8)

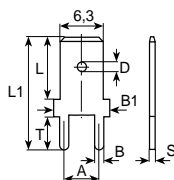

lose / en vrac / in bulk

magaziniert / emmagasiné / wired

6,3 mm

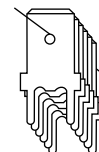
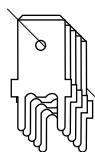
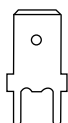
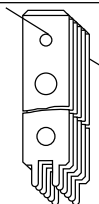
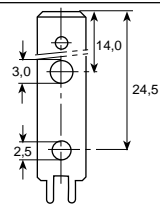

Artikel-Nr. Numéro d'article Part-No.	3866P.6() MS	03866P.6() MS	3866U.6() MS	03866U.6() MS	3866R.6() MS	3866Z.6() MS	03866Z.6() MS
Print Bohrung Trou Hole	Ø 0.9/1.0 T 3.0 L - L1 31.5 B1 6.3 A 2.5 D 1.65 B 0.8 S 0.8	Ø 0.9/1.0 T 3.0 L - L1 31.5 B1 6.3 A 2.5 D 1.65 B 0.8 S 0.8	Ø 1.0/1.1 T 4.5 L 8.5 L1 15.3 B1 8.0 A 5.0 D 1.65 B 1.0 S 0.4	Ø 1.0/1.1 T 4.5 L 8.5 L1 15.3 B1 8.0 A 5.0 D 1.65 B 1.0 S 0.4	Ø 1.1 T 3.0 L - L1 35.5 B1 6.3 A 5.0 D 1.8 B 1.0 S 0.8	Ø 1.1 T 3.5 L 8.5 L1 14.3 B1 8.0 A 5.0 D 1.65 B 1.0 S 0.8	Ø 1.1 T 3.5 L 8.5 L1 14.3 B1 8.0 A 5.0 D 1.65 B 1.0 S 0.8
Stand.-Packg.	1000	2000	2000	3750	1000	1000	2000
Werkzeuge Outils / Tools	1037/38	1046P	1037/40	1046U	1037/38	1037/23	1046

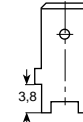
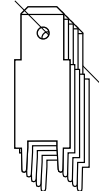
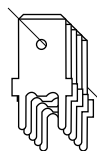

Artikel-Nr. Numéro d'article Part-No.	3866G.6() MS	03866G.6() MS	3865T.7() NS	03865T.7() NS	3865F.7() NS	3865S.7() NS	3866T.6() MS
Print Bohrung Trou Hole	Ø 1.1 T 4.5 L 8.5 L1 15.3 B1 8.0 A 5.0 D 1.65 B 1.0 S 0.8	Ø 1.1 T 4.5 L 8.5 L1 15.3 B1 8.0 A 5.0 D 1.65 B 1.0 S 0.8	Ø 1.1/1.2 T 3.6 L 8.0 L1 24.8 B1 8.0 A 5.0 D 1.65 B 1.0 S 0.8	Ø 1.1/1.2 T 3.6 L 8.0 L1 24.8 B1 8.0 A 5.0 D 1.65 B 1.0 S 0.8	Ø 1.2 T 3.0 L 8.0 L1 38.2 B1 7.5 A 6.5 D 1.7x3.9 B 1.0 S 0.8	Ø 1.2 T 3.0 L 8.0 L1 38.2 B1 7.5 A 6.5 D 1.7 B 1.0 S 0.8	Ø 1.3 T 1.5 L 8.5 L1 14.4 B1 8.0 A 5.0 D 1.65 B 1.3 S 0.8
Stand.-Packg.	1000	2000	1000	2000	1000	1000	1000
Werkzeuge Outils / Tools	1037/23	1046	1037/23	1046T	1037/23	1037/23	1037/23



Steckungen für gedruckte Schaltungen

Masse im Steckbereich
 DIN 46342 Teil 1

Languettes plates pour circuits imprimés

Dimensions zone d'emboîtement selon
 DIN 46342 partie 1

Mounting tabs for printed circuitry

Dimensions in the tab sector
 DIN 46342 part 1

6,3 mm

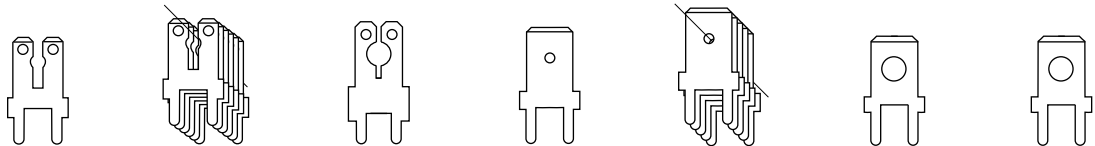

Artikel-Nr. Numéro d'article Part-No.	3866C.2() BZ 3866C.6() MS	03866C.2() BZ 03866C.6() MS	3866Q.6() MS	3866A.2() BZ 3866A.6() MS	03866A.2() BZ 03866A.6() MS	3866V.6() MS	3866X.6() MS
Print Bohrung → Trou Hole	Ø 1.3 T 3.5 L 8.5 L1 14.5 B1 8.0 A 5.0 D 1.8 B 1.3 S 0.8	Ø 1.3 T 3.5 L 8.5 L1 14.5 B1 8.0 A 5.0 D 1.8 B 1.3 S 0.8	Ø 1.3 T 3.5 L 8.2 L1 16.1 B1 8.0 A 5.0 D 3.2 B 1.3 S 0.8	Ø 1.3 T 3.6 L 8.0 L1 14.2 B1 8.0 A 5.0 D 1.65 B 1.3 S 0.8	Ø 1.3 T 3.6 L 8.0 L1 14.2 B1 8.0 A 5.0 D 1.65 B 1.3 S 0.8	Ø 1.3 T 3.6 L 8.0 L1 14.2 B1 8.0 A 5.0 D 3.2 B 1.3 S 0.8	Ø 1.3 T 3.6 L 8.0 L1 14.2 B1 8.0 A 5.0 D 3.5 B 1.3 S 0.8
Stand.-Packg.	1000	2000	1000	1000	2000	1000	1000
Werkzeuge Outils / Tools	1037/23	1046C	1037/23	1037/23	1046	1037/23	1037/23

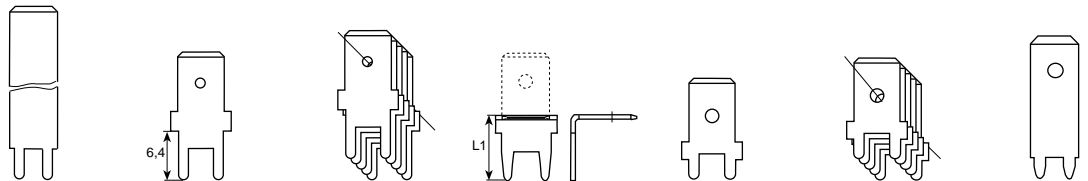

Artikel-Nr. Numéro d'article Part-No.	3866Y.6() MS	3866B.2() BZ 3866B.6() MS	03866B.2() BZ 03866B.6() MS	3866B90.6() MS	3866L.6() MS	03866L.6() MS	3866F.6() MS 3866F.9() ST
Print Bohrung → Trou Hole	Ø 1.3 T 4.0 L - L1 48.0 B1 6.3 A 4.0 D - B 1.3 S 0.8	Ø 1.3 T 4.1 L 8.0 L1 16.8 B1 8.0 A 5.0 D 1.65 B 1.3 S 0.8	Ø 1.3 T 4.1 L 8.0 L1 16.8 B1 8.0 A 5.0 D 1.65 B 1.3 S 0.8	Ø 1.3 T 4.1 L 8.0 L1 8.0 B1 8.0 A 5.0 D 1.65 B 1.3 S 0.8	Ø 1.4 T 2.6 L 8.1 L1 13.2 B1 8.0 A 5.0 D 1.65 B 1.35 S 0.8	Ø 1.4 T 2.6 L 8.1 L1 13.2 B1 8.0 A 5.0 D 1.65 B 1.35 S 0.8	Ø 1.4/1.5 T 2.7 L - L1 18.7 B1 6.3 A 4.0 D 1.65 B 1.45 S 0.8
Stand.-Packg.	1000	1000	2000	1000	1000	2000	1000
Werkzeuge Outils / Tools	1037/38	1037/23	1046	-	1037/23	1046	1037/23

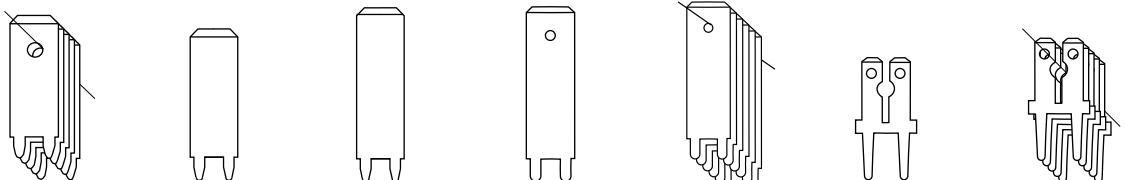

Artikel-Nr. Numéro d'article Part-No.	03866F.6() MS 03866F.9() ST	3865M.6() MS	3867M.6() MS	3866M.6() MS	03866M.6() MS	3866S.2() BZ	03866S.2() BZ
Print Bohrung → Trou Hole	Ø 1.4/1.5 T 2.7 L - L1 18.7 B1 6.3 A 4.0 D 1.65 B 1.45 S 0.8	Ø 1.4/1.5 T 3.0 L - L1 20.0 B1 6.3 A 4.0 D - B 1.5 S 0.8	Ø 1.4/1.5 T 3.0 L - L1 23.0 B1 6.3 A 4.0 D - B 1.5 S 0.8	Ø 1.4/1.5 T 3.0 L - L1 23.0 B1 6.3 A 4.0 D 1.65 B 1.5 S 0.8	Ø 1.4/1.5 T 3.0 L - L1 23.0 B1 6.3 A 4.0 D 1.65 B 1.5 S 0.8	Ø 1.5 T 6.0 L 8.2 L1 16.0 B1 8.0 A 5.0 D 1.8 B 1.45 S 0.8	Ø 1.5 T 6.0 L 8.2 L1 16.0 B1 8.0 A 5.0 D 1.8 B 1.45 S 0.8
Stand.-Packg.	2000	1000	1000	1000	2000	1000	2000
Werkzeuge Outils / Tools	1046F	1037/38	1037/38	1037/38	1046M	1037/23	1046S



Steckzungen für gedruckte Schaltungen

Masse im Steckbereich
 DIN 46342 Teil 1

Languettes plates pour circuits imprimés

Dimensions zone d'emboîtement selon
 DIN 46342 partie 1

Mounting tabs for printed circuitry

Dimensions in the tab sector
 DIN 46342 part 1

Werkstoff:

BZ = Bronze
 MS = Messing
 NS = Neusilber

Oberflächenbehandlung: Code

bl = blank (0)
 ag = versilbert (1)
 au = vergoldet (2)
 sn = verzinkt (8)

Bestellbeispiel:
Exemple de commande:
Example of order:

3867D.68 lose / en vrac / in bulk
 (3867D MS sn)

magaziniert / emmagasiné / wired
3867D.68
 (03867D MS sn)

Matière:

BZ = bronze
 MS = laiton
 NS = maillechort

Traitements de surface: Code

bl = brut (0)
 ag = argenté (1)
 au = doré (2)
 sn = étamé (8)

Material:

BZ = bronze
 MS = brass
 NS = german silver

Surface-plating: Code

bl = clean (0)
 ag = silver-plated (1)
 au = gold-plated (2)
 sn = tin-plated (8)

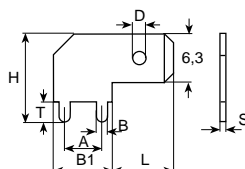

lose / en vrac / in bulk

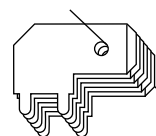

magaziniert / emmagasiné / wired

6,3 mm

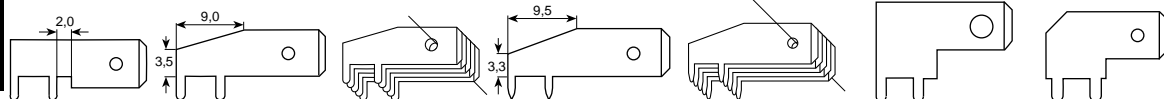

Artikel-Nr. Numéro d'article Part-No.	3867C.6() MS	3867D.2() BZ 3867D.6() MS	03867D.2() BZ 03867D.6() MS	3867D1.6() MS	03867D1.6() MS	3867L.6() MS	3867B.2() BZ 3867B.6() MS
Print Bohrung Trou Hole	Ø 1.0 T 3.2 H 8.0 A 5.0 B1 6.0 L 12.0 D 1.65 B 1.0 S 0.8	Ø 1.0 T 3.0 H 9.3 A 5.0 B1 6.0 L 14.0 D 1.65 B 1.0 S 0.8	Ø 1.0 T 3.0 H 9.3 A 5.0 B1 6.0 L 14.0 D 1.65 B 1.0 S 0.8	Ø 1.0 T 3.0 H 9.3 A 5.0 B1 6.0 L 15.5 D 1.65 B 1.0 S 0.8	Ø 1.0 T 3.0 H 9.3 A 5.0 B1 6.0 L 15.5 D 1.65 B 1.0 S 0.8	Ø 1.1/1.2 T 3.0 H 13.2 A 5.0 B1 8.0 L 10.0 D 3.0 B 1.0 S 0.8	Ø 1.3 T 3.0 H 12.0 A 5.0 B1 8.0 L 8.2 D 1.65 B 1.3 S 0.8
Stand.-Packg.	1000	1000	2000	1000	2000	1000	1000
Werkzeuge Outils / Tools	1037/26	1037/33	1046D	1037/33	1046D1	1037/28	1037/28

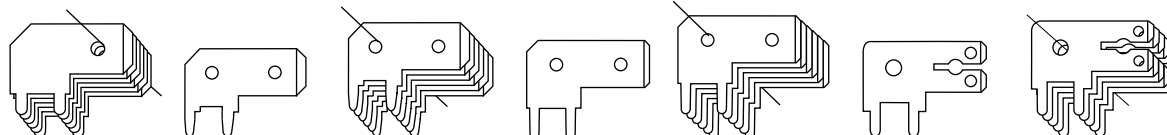

Artikel-Nr. Numéro d'article Part-No.	03867B.2() BZ 03867B.6() MS	3868A.6() MS	03868A.6() MS	3867E.6() MS	03867E.6() MS	3867K.6() MS	03867K.6() MS
Print Bohrung Trou Hole	Ø 1.3 T 3.0 H 12.0 A 5.0 B1 8.0 L 8.2 D 1.65 B 1.3 S 0.8	Ø 1.3 T 3.5 H 11.1 A 5.0 B1 6.9 L 9.1 D 1.65 B 1.3 S 0.8	Ø 1.3 T 3.5 H 11.1 A 5.0 B1 6.9 L 9.1 D 1.65 B 1.3 S 0.8	Ø 1.3 T 4.0 H 13.0 A 5.0 B1 7.0 L 9.0 D 1.65 B 1.3 S 0.8	Ø 1.3 T 4.0 H 13.0 A 5.0 B1 7.0 L 9.0 D 1.65 B 1.3 S 0.8	Ø 1.3/1.4 T 3.5 H 12.5 A 5.0 B1 8.0 L 8.2 D 1.65 B 1.3 S 0.8	Ø 1.3/1.4 T 3.5 H 12.5 A 5.0 B1 8.0 L 8.2 D 1.65 B 1.3 S 0.8
Stand.-Packg.	2000	1000	2000	1000	2000	1000	2000
Werkzeuge Outils / Tools	1046B	1037/28	1046A	1037/28	1046E	1037/28	1046K



Vogt Verbindungstechnik

**6,3
mm**

Steckzungen für gedruckte Schaltungen

Masse im Steckbereich
DIN 46342 Teil 1

Languettes plates pour circuits imprimés

Dimensions zone d'emboîtement selon
DIN 46342 partie 1

Mounting tabs for printed circuitry

Dimensions in the tab sector
DIN 46342 part 1

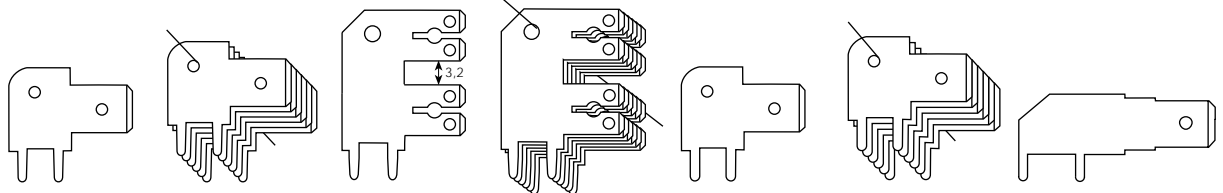

Artikel-Nr. Numéro d'article Part-No.	3867A.6() MS	03867A.6() MS	3867X.6() MS	03867X.6() MS	3867G.6() MS	03867G.6() MS	3867V.6() MS
Print Bohrung Trou Hole	Ø 1.4	Ø 1.4	Ø 1.4/1.5	Ø 1.4/1.5	Ø 1.5	Ø 1.5	Ø 1.5
	T 4.0	T 4.0	T 4.0	T 4.0	T 4.0	T 4.0	T 3.5
	H 15.0	H 15.0	H 22.5	H 22.5	H 15.0	H 15.0	H 11.5
	A 5.0	A 5.0	A 5.0	A 5.0	A 5.0	A 5.0	A 7.5
	B1 8.0	B1 8.0	B1 8.0	B1 8.0	B1 7.9	B1 7.9	B1 14.0
	L 8.5	L 8.5	L 8.2	L 8.2	L 8.4	L 8.4	L 12.0
	D 1.65	D 1.65	D 1.65	D 1.65	D 1.65	D 1.65	D 1.65
	B 1.4	B 1.4	B 1.4	B 1.4	B 1.4	B 1.4	B 1.4
	S 0.8	S 0.8	S 0.8	S 0.8	S 0.8	S 0.8	S 0.8
Stand.-Packg.	1000	2000	1000	2000	1000	2000	1000
Werkzeuge Outils / Tools	1037/27	1046W	1037/28	1046X	1037/27	1046W	1037/28

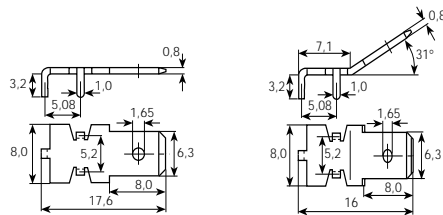

Artikel-Nr. Numéro d'article Part-No.	3867P.6() MS	3867R.6() MS
Print Bohrung Trou Hole	Ø 1.2	Ø 1.2
Stand.-Packg.	1000	1000

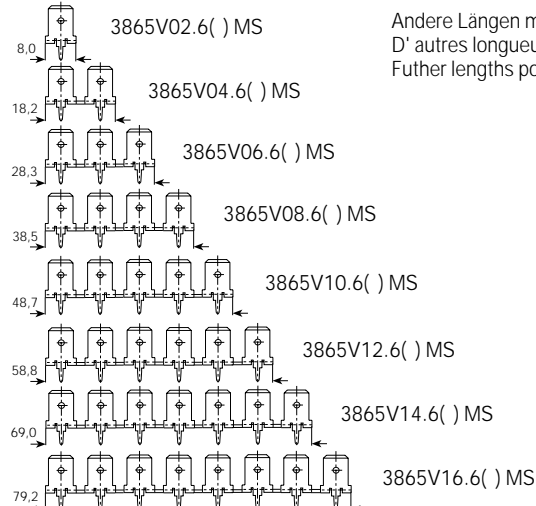
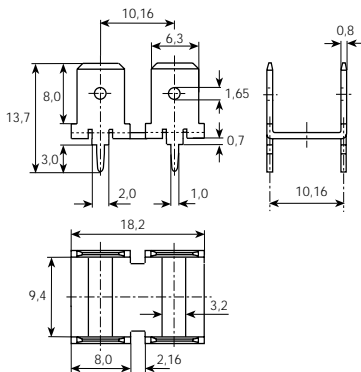

Andere Längen machbar auf Anfrage
D' autres longueurs faisables sur demande
Further lengths possible on request

Artikel-Nr. Numéro d'article Part-No.	3865V04.6() MS
Print Bohrung Trou Hole	Ø 1.3
Stand.-Packg.	1000