

## Display ▪ Through-hole ELF-511SYGWA/S530-E2

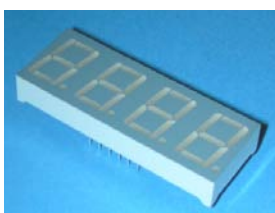

### Features

- Industrial standard size.
- Low power consumption.
- Categorized for luminous intensity.
- The product itself will remain with RoHS Compliant version.
- Compliance with EU REACH.
- Compliance with Pb free.

### Description

- The ELF-511SYGWA/S530-E2 is a 14.22mm (0.56") digit height seven-segment display.
- The display provides excellent reliability in bright ambient light.
- The device is made with white segments and gray surface.

### Applications

- Home appliances
- Instrument panels
- Digital readout displays

## Device Selection Guide

Chip Materials	Emitted Color	Resin Color
AlGaInP	Brilliant Yellow Green	White Diffusion

## Absolute Maximum Ratings (Ta=25°C)

Parameter	Symbol	Rating	Unit
Reverse Voltage	$V_R$	5	V
Forward Current	$I_F$	25	mA
Peak Forward Current (Duty 1/10 @1KHz)	$I_{FP}$	60	mA
Power Dissipation	$P_d$	60	mW
Operating Temperature	$T_{opr}$	-40 ~ +85	°C
Storage Temperature	$T_{stg}$	-40 ~ +90	°C
Soldering Temperature	$T_{sol}$	Wave Soldering : 260 °C for 5 sec. Hand Soldering : 350 °C for 3 sec.	

## Electro-Optical Characteristics (Ta=25°C)

Parameter	Symbol	Min.	Typ.	Max.	Unit	Condition
Luminous Intensity <sup>*1</sup>	$I_v$	2.8	6.4	-----	mcd	$I_F=10mA$
Peak Wavelength	$\lambda_p$	-----	575	-----	nm	$I_F=20mA$
Dominant Wavelength	$\lambda_d$	-----	573	-----	nm	$I_F=20mA$
Spectrum Radiation Bandwidth	$\Delta\lambda$	-----	20	-----	nm	$I_F=20mA$
Forward Voltage	$V_F$	-----	2.0	2.4	V	$I_F=20mA$
Reverse Current	$I_R$	-----	-----	100	μA	$V_R=5V$

Note:

- Luminous Intensity is a average value which is measured one 7-segment.
- Tolerance of Luminous Intensity: ± 10 %
- Tolerance of Forward Voltage: ± 0.1V

**Typical Electro-Optical Characteristics Curves**

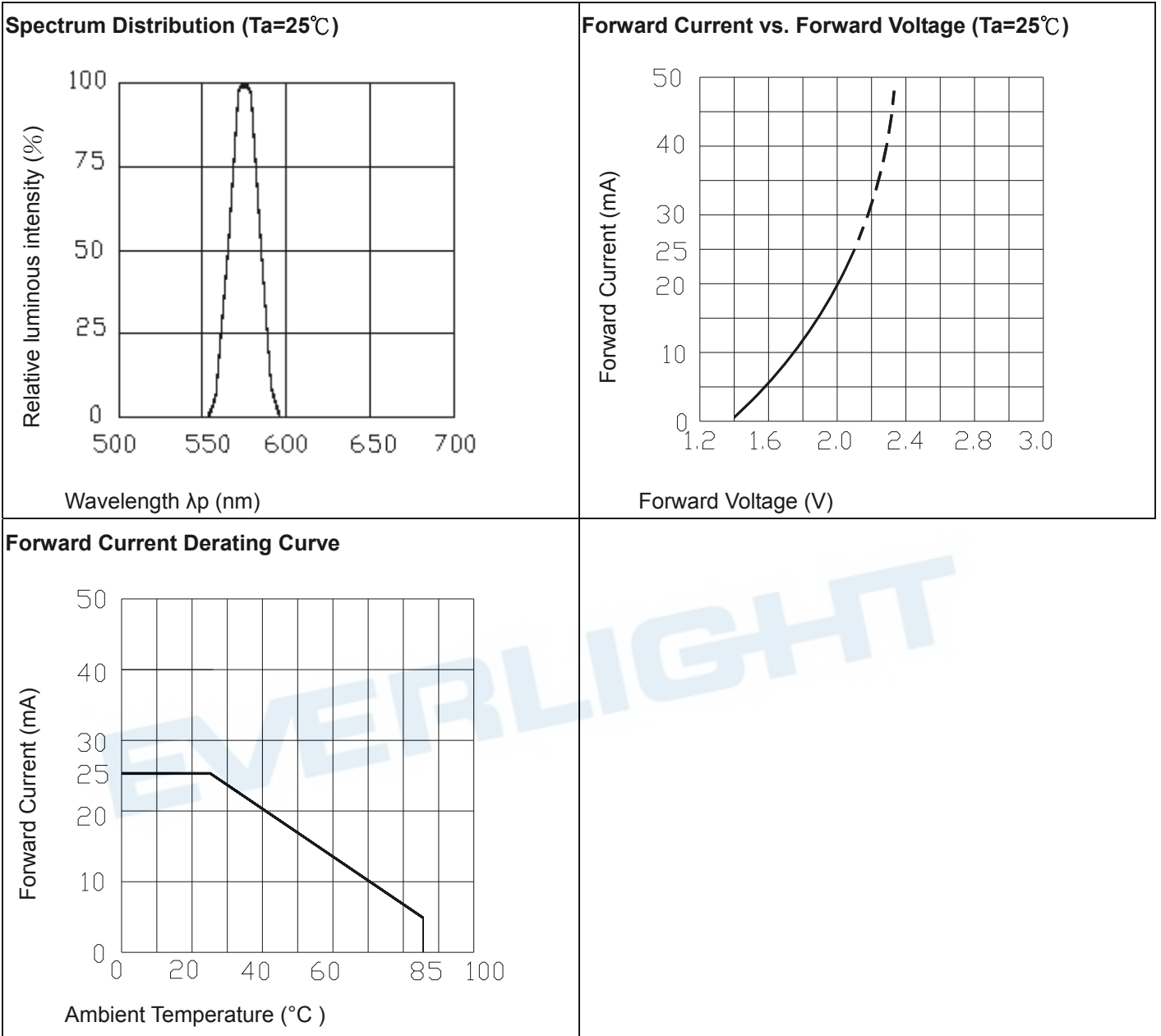

Package Dimension & Internal Circuit Diagram

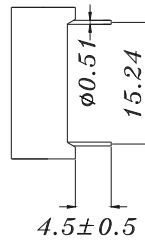
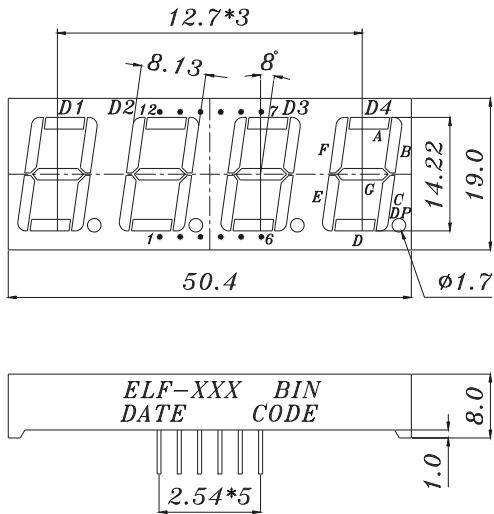

- COMMON CATHODE
- 1 ANODE E
  - 2 ANODE D
  - 3 ANODE DP
  - 4 ANODE C
  - 5 ANODE G
  - 6 COMMON CATHODE D4
  - 7 ANODE B
  - 8 COMMON CATHODE D3
  - 9 COMMON CATHODE D2
  - 10 ANODE F
  - 11 ANODE A
  - 12 COMMON CATHODE D1

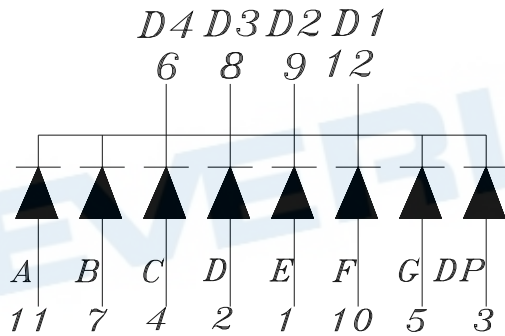

Note: Tolerances unless mentioned ±0.25mm. Unit = mm

**Packing Materials**

**Label Explanation**

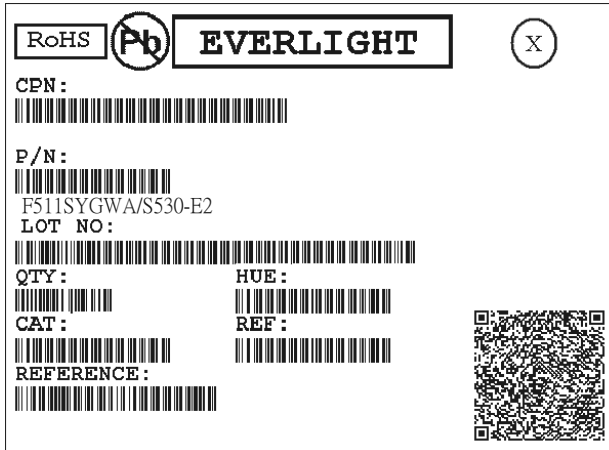

- CPN: Customer's Product Number
- P/N: Product Number
- QTY: Packing Quantity
- CAT: Luminous Intensity Rank
- HUE: Reference
- REF: Reference
- LOT No: Lot Number
- REFERENCE: Volume Label code

**Packing Process**

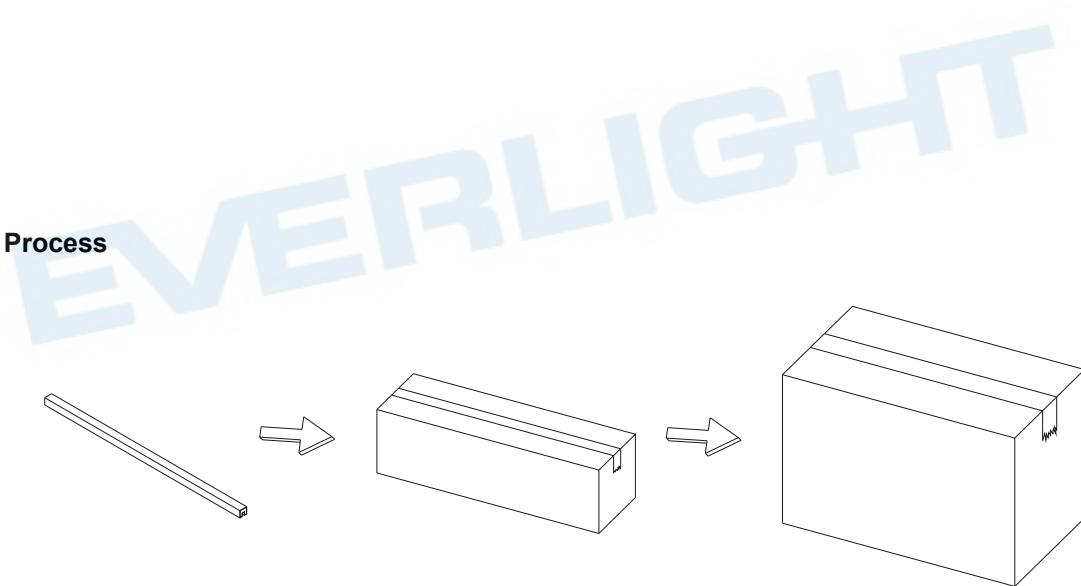

**10 PCS/Tube**

**63 Tubes/Box**

**4 Boxes/Carton**

## Precautions for Use

### 1. Soldering Condition

#### 1.1 Maximum Body Case Temperature Profile for evaluation of DIP Soldering Profile

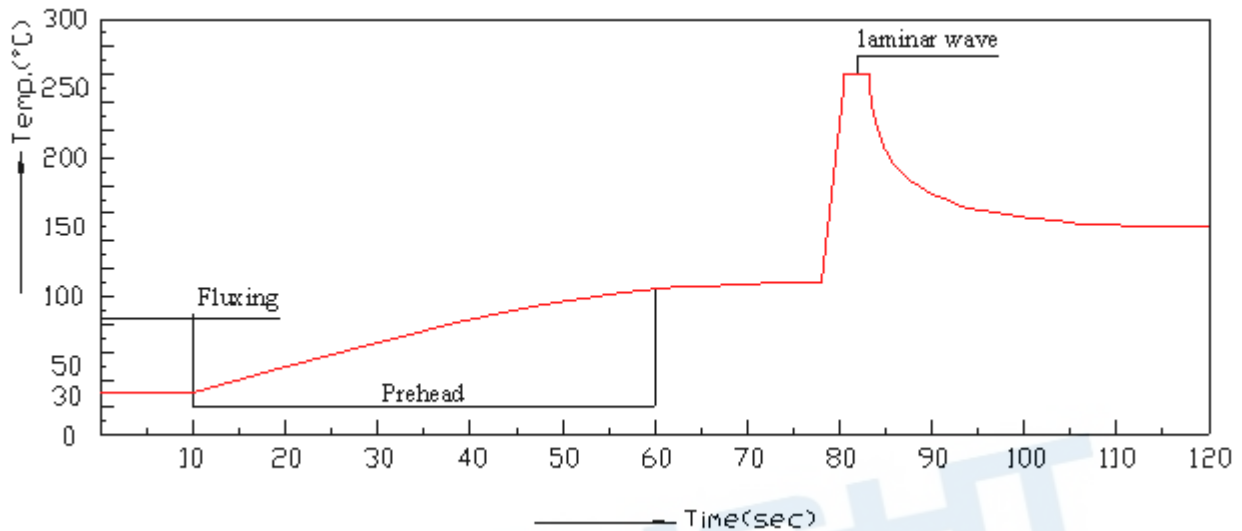

Note:

#### Preheat

Temperature	100 °C
Time	60 seconds max.

#### Other

Bath Temperature	260C
Bath Time	5 seconds max.
DIP Soldering	1 time

All parameters are maximum body case temperature values and cannot be considered as a soldering profile. The body case temperature was measured by soldering a thermal couple to the soldering point of LEDs.

### 2. Soldering Iron

Each terminal is to go to the tip of soldering iron temperature less than 350°C for 3 seconds within once in less than the soldering iron capacity 25W. Leave two seconds and more intervals, and do soldering of each terminal. Be careful because the damage of the product is often started at the time of the hand solder.

## DISCLAIMER

1. EVERLIGHT reserves the right(s) on the adjustment of product material mix for the specification.
2. The Product meet EVERLIGHT published specification for a period of twelve(12 ) months from date of shipment.
3. The graphs shown in this datasheet are representing typical data only and do not show guaranteed values.
4. When using this product, please observe the absolute maximum ratings and the instructions for using outlined in these specification sheets. EVERLIGHT assumes no responsibility for any damage resulting from the use of the product which does not comply with the absolute maximum ratings and the instructions included in these specification sheets.
5. These specification sheets include materials protected under copyright of EVERLIGHT. Reproduction in any form is prohibited without obtaining EVERLIGHT's prior consent.
6. This product is not intended to be used for military, aircraft, automotive, medical, life sustaining or life saving applications or any other application which can result in human injury or death. Please contact authorized Everlight sales agent for special application request.
7. ESD (Electrostatic Discharge)
  - The products are sensitive to static electricity or surge voltage. ESD can damage a die and its reliability.  
When handling the products, the following measures against electrostatic discharge are strongly recommended:
    - Eliminating the charge
      - Grounded wrist strap, ESD footwear, clothes, and floors
      - Grounded workstation equipment and tools
      - ESD table/shelf mat made of conductive materials
    - Proper grounding is required for all devices, equipment, and machinery used in product assembly.  
Surge protection should be considered when designing of commercial products.
    - If tools or equipment contain insulating materials such as glass or plastic, the following measures against electrostatic discharge are strongly recommended:
      - Dissipating static charge with conductive materials
      - Preventing charge generation with moisture
      - Neutralizing the charge with ionizers
8. The LEDs should be operated with forward bias. The driving circuit must be designed so that the LEDs are not subjected to forward or reverse voltage while it is off. If reverse voltage is continuously applied to the LEDs, it may cause migration resulting in LED damage.