

SPECIFICATIONS

CONTACT RATING: 5A @125 VAC or 28 VDC (Q contact)
ELECTRICAL LIFE:50,000 make-and-break cycles at full load
CONTACT RESISTANCE: 10 mΩ max. initial @2-4 VDC,100 mA
INSULATION RESISTANCE: 1,000 MΩ min.
DIELECTRIC STRENGTH: 1,500 V RMS @ sea level.
OPERATING TEMPERATURE: -30°C to +85°C

MATERIALS

CASE - diallyl phthalate ( DAP )
TOGGLE HANDLE - Copper alloy , chrome plated
BUSHING - Copper alloy , nickel plated
HOUSING - Stainless Steel
CONTACT AND TERMINAL - copper alloy, silver plated

How do you build the switches you need!!

The straight type , please see the (A) ;

The right angle P.C terminals, please see the (B)

(A) T 8 0 1 3 - S E C Q - E - S 2 0 - T 1 - 2 -

Table (A) detailing specifications for straight type switches, including columns for Switch Function, Actuator, Bushing, Termination, Vertical support Bracket, and Cap color.

(B) T 8 0 1 9 L - T N Q - E - S - T 2 - 2 -

Table (B) detailing specifications for right angle P.C terminals switches, including columns for Horizon Right Angle, Vertical Right Angle, Switches Function, Actuator, Bushing, Contact Material, and Actuator Cap.



### SPDT



Model No.	Switching position		
T8013	ON	none	ON
T8013A	ON	none	(ON)
T8014	ON	OFF	ON
T8014A	(ON)	OFF	(ON)
T8014B	ON	OFF	(ON)
Term. Comm.	2-3	open	2-1

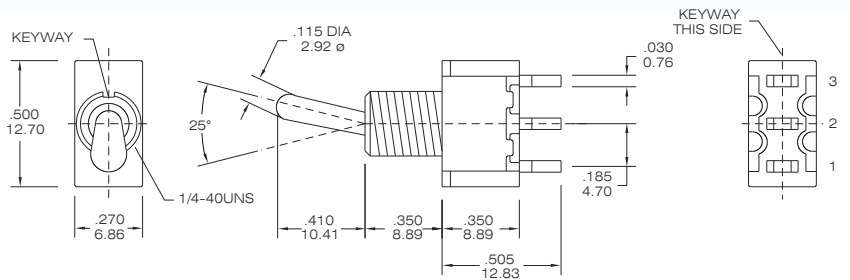

T8013 - SEBQ



### DPDT

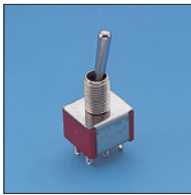

Model No.	Switching position		
T8011	ON	none	ON
T8011A	ON	none	(ON)
T8012	ON	OFF	ON
T8012A	(ON)	OFF	(ON)
T8012B	ON	OFF	(ON)
Term. Comm.	2-3,5-6	open	2-1,5-4
3 way switches (SP3T)			
T812	ON	ON	ON
T812A	(ON)	ON	(ON)
T812B	ON	ON	(ON)
Term. Comm.	2-3,5-6	2-3,5-4	2-1,5-4

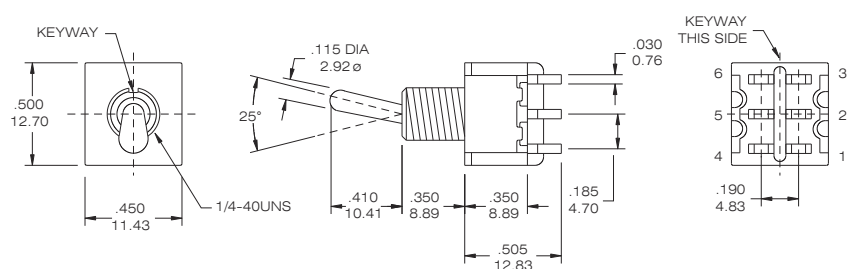

T8011 - SEBQ

Please see page A18 to know more about T812 (3-way Switches)



### 3PDT



Model No.	Switching position		
T8301	ON	none	ON
T8303	ON	none	(ON)
T8305	ON	OFF	ON
T8307	(ON)	OFF	(ON)
T8309	ON	OFF	(ON)
Term. Comm.	2-3,5-6 8-9	open	2-1,5-4 8-7

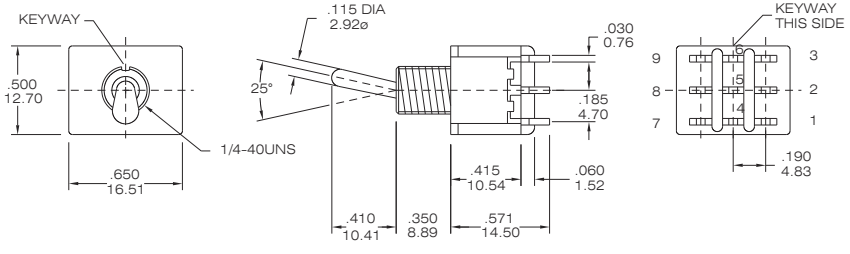

T8301- SEBQ

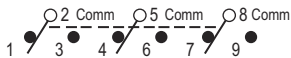

### 4PDT



Model No.	Switching position		
T8401	ON	none	ON
T8403	ON	none	(ON)
T8405	ON	OFF	ON
T8407	(ON)	OFF	(ON)
T8409	ON	OFF	(ON)
Term. Comm.	2-3,5-6 8-9,11-12	open	2-1,5-4 8-7,11-10
3 way switches (DP3T)			
T845	ON	ON	ON
T847	(ON)	ON	(ON)
T849	ON	ON	(ON)
Term. Comm.	2-3,5-6 8-9,11-12	2-3,5-4 8-9,11-10	2-1,5-4 8-7,11-10

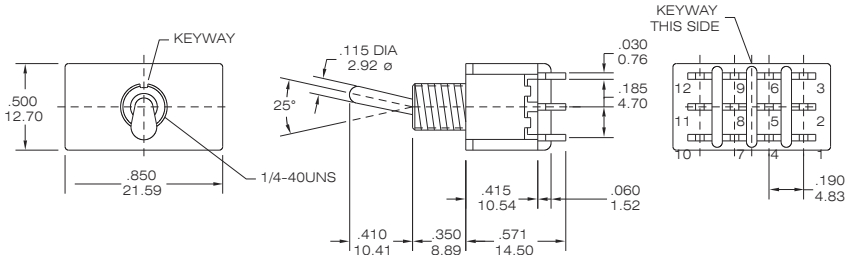

T8401 - SEBQ

Please see page A18 to know more about T845 (3-way Switches)





## FEATURE

The T80-T series P.C.B Mounted Toggle Switches - Right Angle Type - are specially designed for P.C. Boards . Easy to mount and install securely with a vertical support rack . The toggle operates in the same direction as the print connectors . Customers' specifications of pitch are acceptable.

## HORISON RIGHT ANGLE

### SPDT

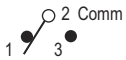

Model No.	Switching position		
T8019	ON	none	ON
T8019A	ON	none	(ON)
T8020	ON	OFF	ON
T8020A	(ON)	OFF	(ON)
T8020B	ON	OFF	(ON)
Term. Comm.	2-3	open	2-1

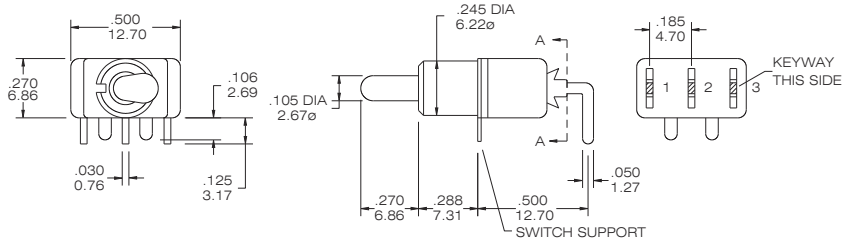

T8019 - TNQ

### DPDT



Model No.	Switching position		
T8021	ON	none	ON
T8021A	ON	none	(ON)
T8022	ON	OFF	ON
T8022A	(ON)	OFF	(ON)
T8022B	ON	OFF	(ON)
Term. Comm.	2-3,5-6	open	2-1,5-4
3 way switches (SP3T)			
T822	ON	ON	ON
T822A	(ON)	ON	(ON)
T822B	ON	ON	(ON)
Term. Comm.	2-3,5-6	2-3,5-4	2-1,5-4

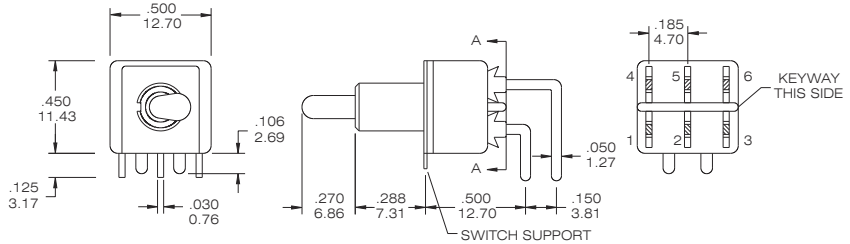

T8021 - TNQ

Please see page A18 to know more about T822 ( 3-way Switches)

### 3PDT

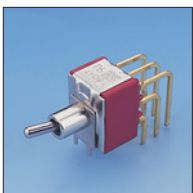

Model No.	Switching position		
T8301P(A)	ON	none	ON
T8303P(A)	ON	none	(ON)
T8305P(A)	ON	OFF	ON
T8307P(A)	(ON)	OFF	(ON)
T8309P(A)	ON	OFF	(ON)
Term. Comm.	2-3,5-6 8-9	open	2-1,5-4 8-7

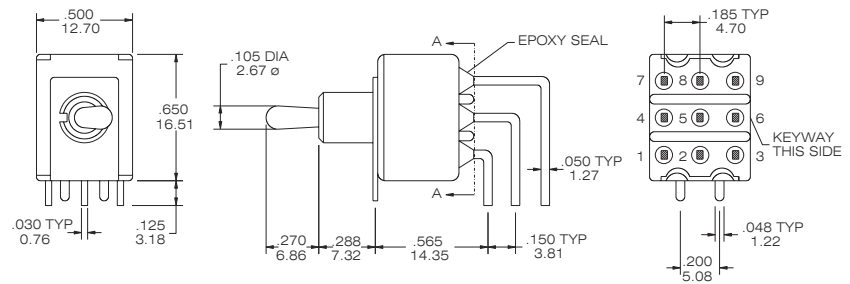

T8301P(A)- TNQ

## P.C.B MOUNTING DIMENSIONS

FOR T8019-T8020B

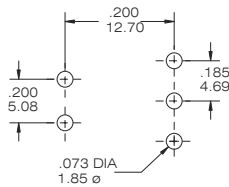

FOR T8021-T8022B

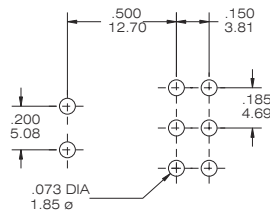

FOR T8301P(A)-T8309P(A)

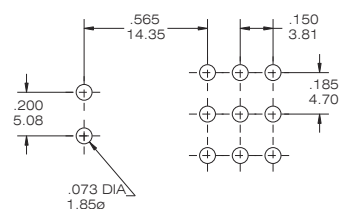



## VERTICAL RIGHT ANGLE

### SPDT

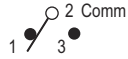

Model No.	Switching position		
T8019L	ON	none	ON
T8019LA	ON	none	(ON)
T8020L	ON	OFF	ON
T8020LA	(ON)	OFF	(ON)
T8020LB	ON	OFF	(ON)
Term. Comm.	2-3	open	2-1

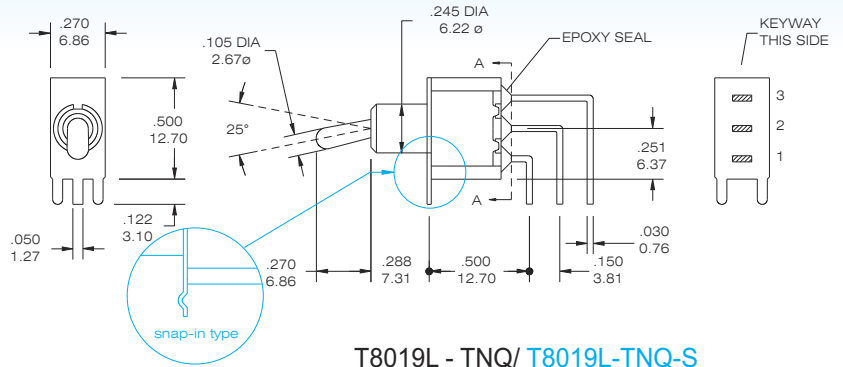

T8019L - TNQ/ T8019L-TNQ-S

### DPDT

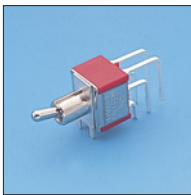

Model No.	Switching position		
T8021L	ON	none	ON
T8021LA	ON	none	(ON)
T8022L	ON	OFF	ON
T8022LA	(ON)	OFF	(ON)
T8022LB	ON	OFF	(ON)
Term. Comm.	2-3,5-6	open	2-1,5-4
3 way switches (SP3T)			
T822L	ON	ON	ON
T822LA	(ON)	ON	(ON)
T822LB	ON	ON	(ON)
Term. Comm.	2-3,5-6	2-3,5-4	2-1,5-4

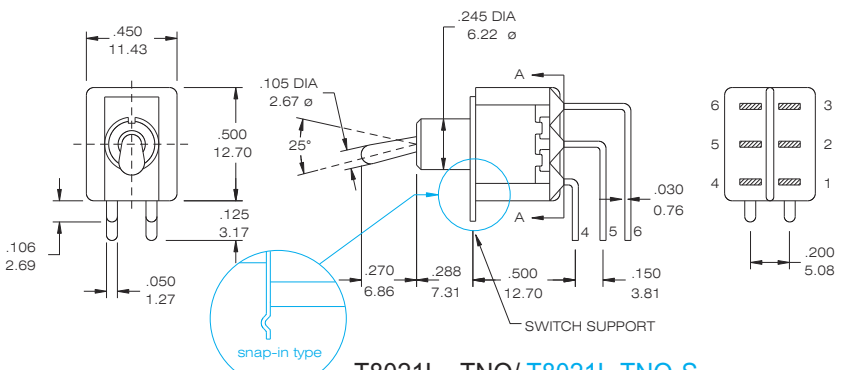

T8021L - TNQ/ T8021L-TNQ-S

Please see page A18 to know more about T822L ( 3-way Switches)

### 3PDT

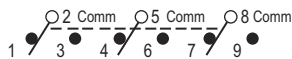

Model No.	Switching position		
T8301P	ON	none	ON
T8303P	ON	none	(ON)
T8305P	ON	OFF	ON
T8307P	(ON)	OFF	(ON)
T8309P	ON	OFF	(ON)
Term. Comm.	2-3,5-6 8-9	open	2-1,5-4 8-7

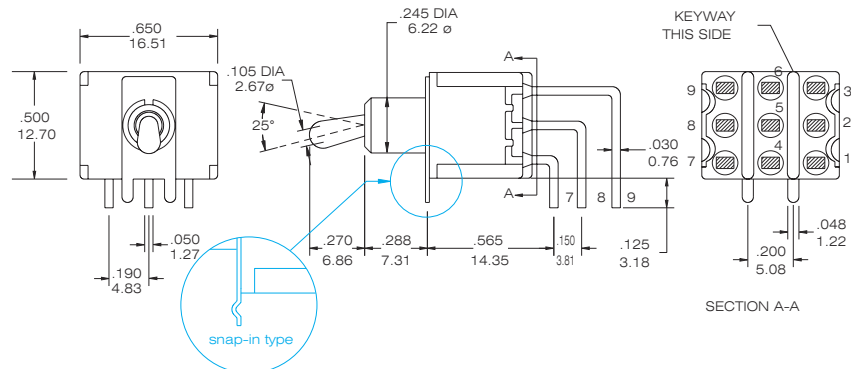

T8301P- TNQ/ T8301P-TNQ-S

### 4PDT

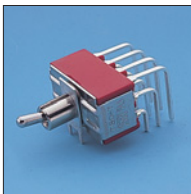

Model No.	Switching position		
T8401P	ON	none	ON
T8403P	ON	none	(ON)
T8405P	ON	OFF	ON
T8407P	(ON)	OFF	(ON)
T8409P	ON	OFF	(ON)
Term. Comm.	2-3,5-6 8-9,11-12	open	2-1,5-4 8-7,11-10
3 way switches (DP3T)			
T845P	ON	ON	ON
T847P	(ON)	ON	(ON)
T849P	ON	ON	(ON)
Term. Comm.	2-3,5-6 8-9,11-12	2-3,5-4 8-9,11-10	2-1,5-4 8-7,11-10

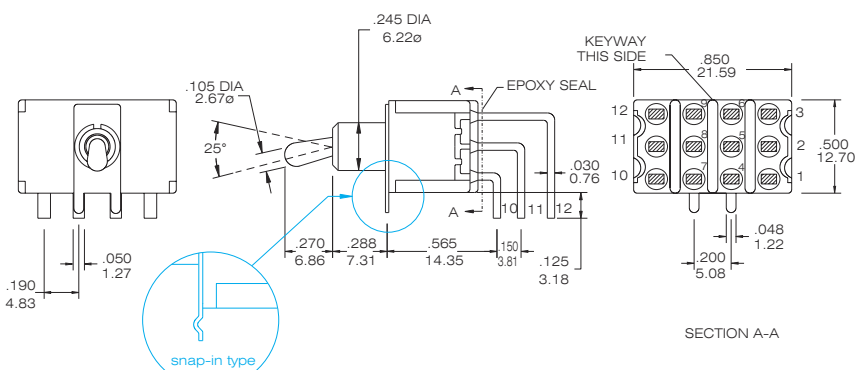

T8401P- TNQ/ T8401P-TNQ-S

Please see page A18 to know more about T845P ( 3-way Switches)

### P.C.B MOUNTING DIMENSIONS

FOR T8019L-T8020LB

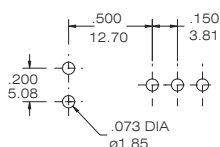

FOR T8021L-T8022LB

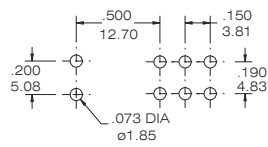

FOR T8301P-T8309P

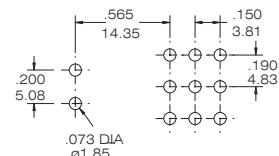

FOR T8401P-T8409P

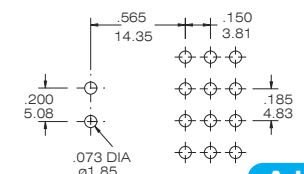



# T80-T

# Miniature Toggle Switches



## Actuator Option

S (STD)

T (STD)

X LONG

W LONG

V LONG

Y PLASTIC

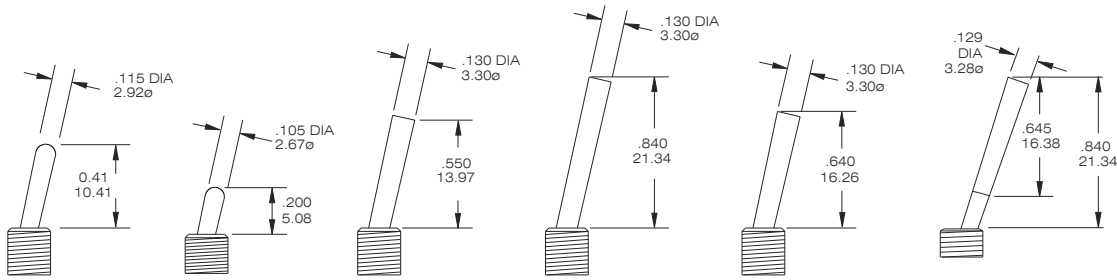

Y HANDLE COLOR NO.	COLOR
1	White
2	Black(std.)
3	Red

the height of actuator is with bushing "E". It will be difference with other bushing option

Now the available color is "2". If you need the others, please inquire first.

### Flatted Actuator ( ONLY APPLY "H""H1""H2" BUSHING)

U (standard)

U1 ( short )

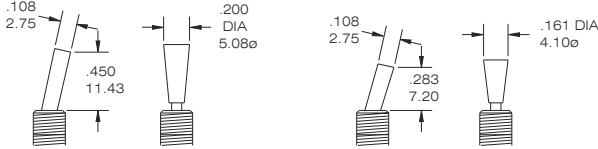

U2 ( long )

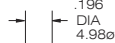

### Locking Lever

LK (round top)

LK1 (flat top)

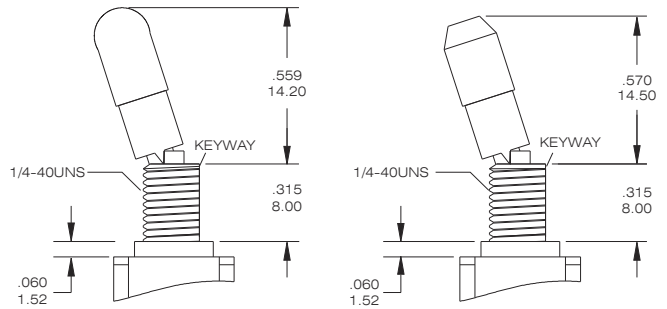

Bushing Option Code not required unless

(1) " L " splashproof bushing ordered --LKL / LK1L

(2) non-thread ordered,choose the bushing code "N" -- LKN / LK1N

Z LARGE TOGGLE  
Z4 ANTIROTATION

Z1 LARGE TOGGLE  
Z3 ANTIROTATION

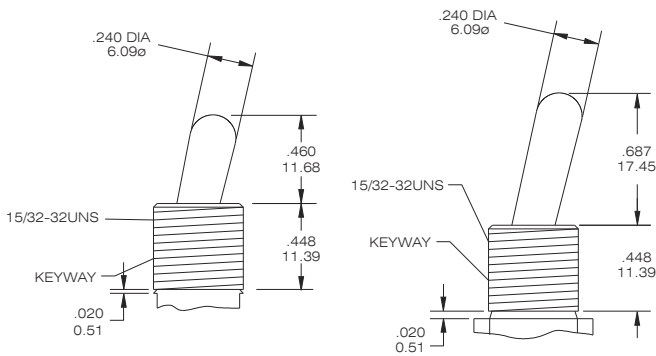

Bushing Option Code not required unless " L " splashproof bushing ordered.

## Rubber Hood Sealing

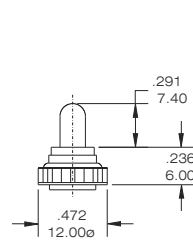

K1=METRIC  
E1=INCH  
E1-L=INCH **NEW**

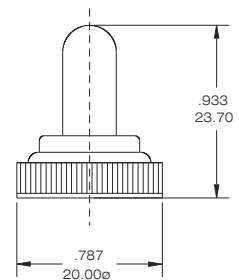

E2 for the large toggle (15/32-32UNS)

## Toggle Cap Option

T1 for actuator "S" only

T2 for actuator "T"

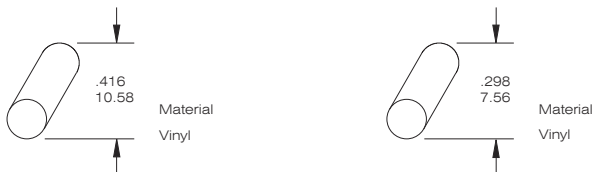

code	color	code	color	code	color	code	color
0	transparent	1	white	2	black	3	red
4	orange	5	yellow	6	green	7	blue

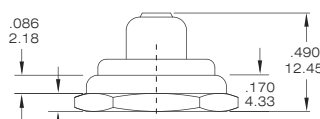

E3 for the large toggle (15/32-32UNS)

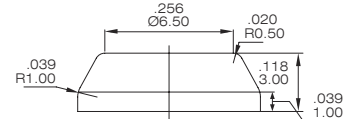

E6 O RING





## Bushing Option

**E THD STD. TYPE  
M NON-THD**

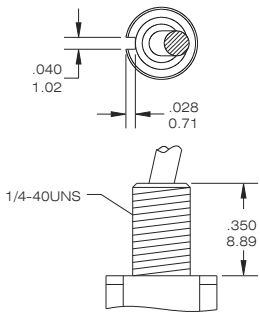

**F THD.  
N NON-THD**

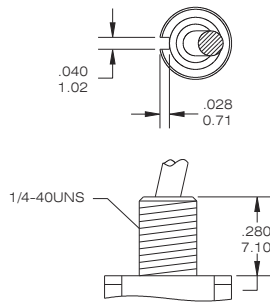

**HIGH TORQUE  
G: THD STD. TYPE  
G1: NON-THD**

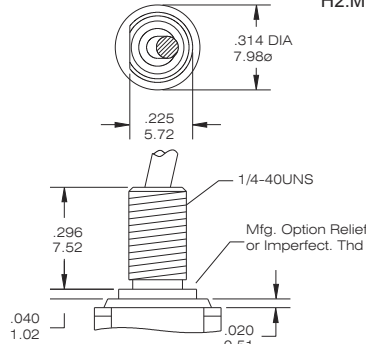

**HIGH TORQUE  
H: THD STD. TYPE  
H1: NON-THD  
H2: METRIC**

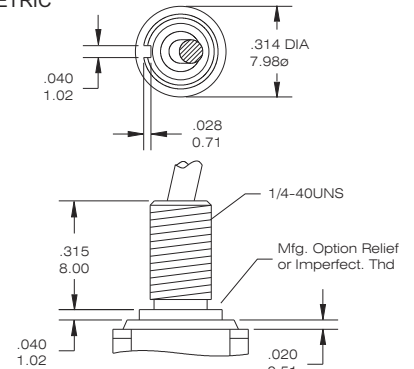

**LONG  
J: THD STD. TYPE  
J1: NON-THD**

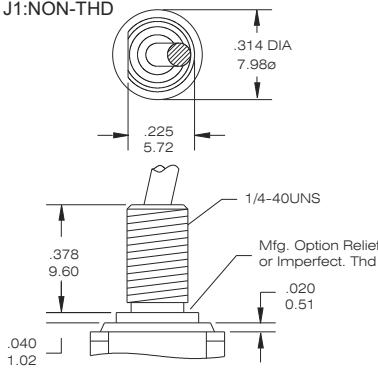

**K METRIC**

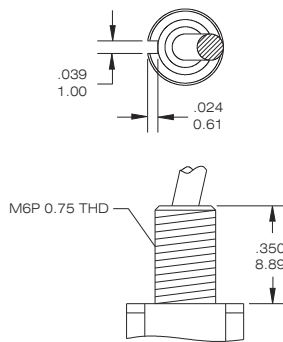

## Splash water proof Solution L SPLASH-PROOF

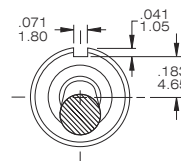
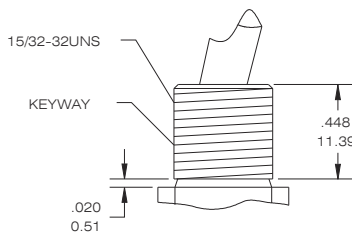
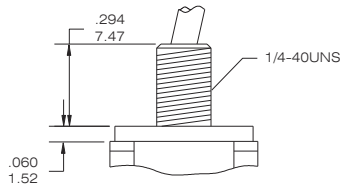
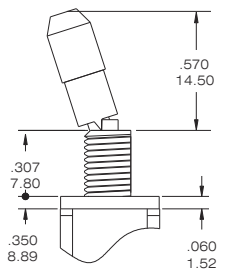
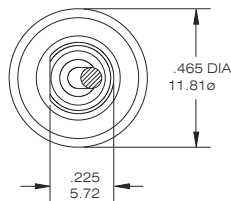
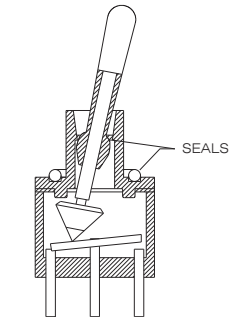

### Panel Mounting

#### 1/4 IN. BUSHING

#### METRIC BUSHING

#### 15/32 IN. BUSHING

## W SPLASH-PROOF

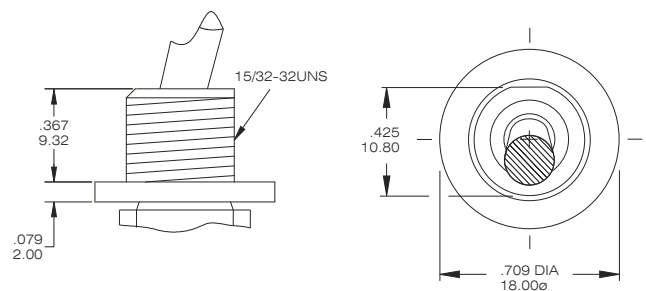

INDEX  
TOGGLE  
ROCKER  
SLIDE  
PUSH BUTTON / MICRO  
DIP / ROTARY  
KEY / TACT



## TERMINAL OPTION (ONLY FOR THE STRAIGHT TYPE T8013~T8401)

## TERMINAL SEAL OPTION

B SOLDER LUG    C PRINTED CIRCUIT    D QUICK CONNECT    WIREWRAP

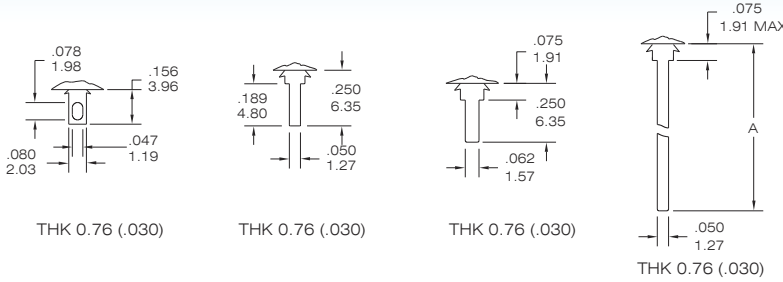

CODE	"A"dimension
D1	.750 (19.05)
D3	.425 (10.8)

E TERMINAL SEAL

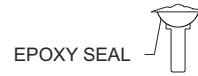

## CONTACT MATERIAL OPTIONS

CODE	CONTACT MATERIAL	TERMINAL MATERIAL	RATING
Q	Silver plated	Silver plated	5 A @ 125 V AC or 28 V DC; 3 A @ 250 VAC
R	Gold plated over nickel plated	Gold plated over nickel plated	0.4VA MAX @ 20 V AC or DC MAX
G	Gold plated over silver plated	Gold plated over silver plated	0.4 VA MAX @ 20 V AC or DC MAX or 5 A @ 125V AC or 28 VDC; 3 A @ 250 VAC
K	Gold plated over nickel plated	Tin over nickel plated	0.4VA MAX @ 20 V AC or DC MAX

\* The K option is only for some special item. Please inquire first when you need the "K" option

## VERTICAL SUPPORT BRACKET OPTION

( only apply the straight type terminal -page A12. Please build the terminal option "c" code)

SPDT

S20/S25/V20/V25

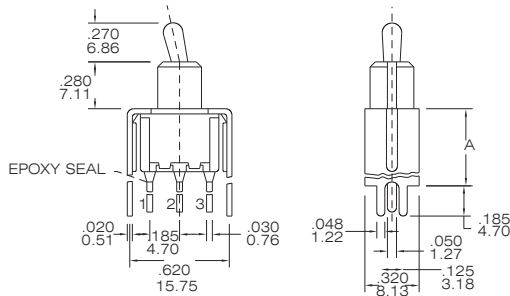

T8013 - TNCQ-S20(S25)

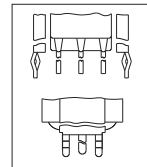

SNAP-IN V20/ V25

CODE	"A"dimension
S20/V20	.460 (11.68)
S25/V25	.630 (16.00)

V20/V25 : the snap-in type

DPDT

S20/S25/V20/V25

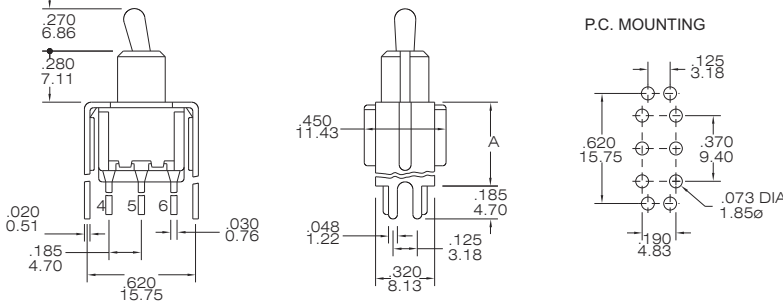
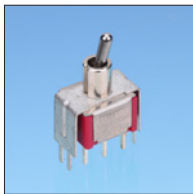

T8011 - TNCQ-S20(S25)

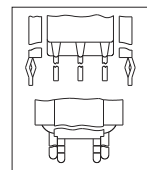

SNAP-IN V20/ V25

CODE	"A"dimension
S20/V20	.460 (11.68)
S25/V25	.630 (16.00)

V20/V25 : the snap-in type

SPDT

S35/S40/V35/V40

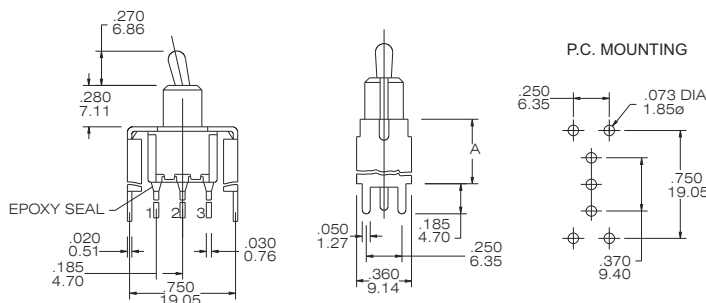
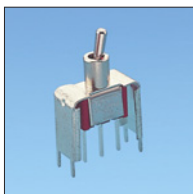

T8013 - TNCQ-S35(S40)

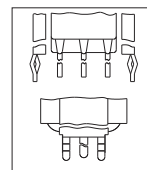

SNAP-IN V35/ V40

CODE	"A"dimension
S35/V35	.460 (11.68)
S40/V40	.630 (16.00)

V35/V40 : the snap-in type

S35 / S40/ V35/V40

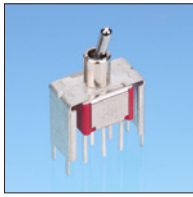

DPDT

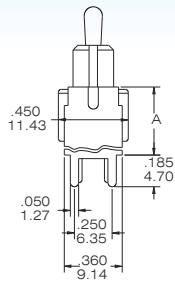
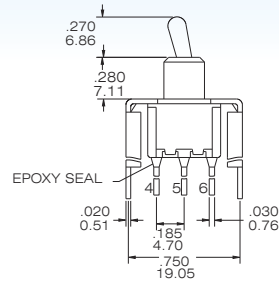

P.C. MOUNTING

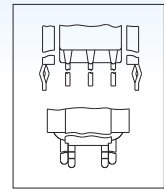
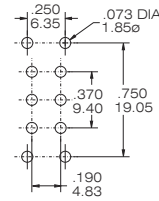

SNAP-IN  
V35/ V40

CODE	"A" dimension
S35/V35	.460 (11.68)
S40/V40	.630 (16.00)
V35/V40 : the snap-in type	

T8011 - TNCQ-S35(S40)

## The hardware of T80-T TOGGLE SWITCHES

NUT

STD.

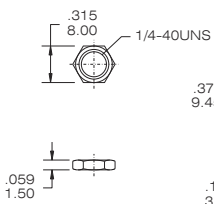

DRESS NUT

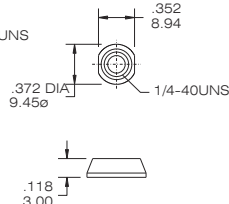

METRIC NUT

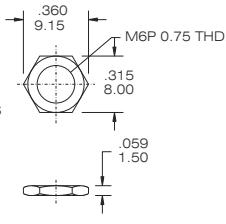

STD. FOR Z Z1

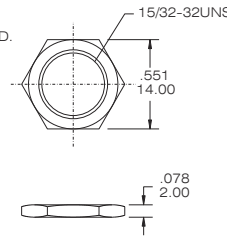

DRESS NUT FOR Z Z1

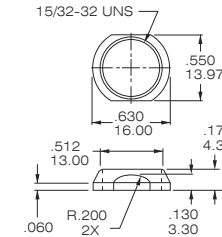

KNURLED NUT

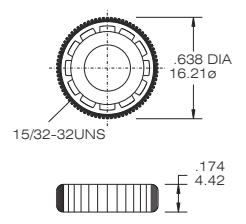

LOCKING RING

STD

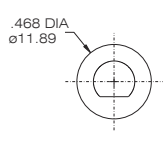
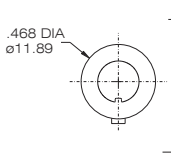

STD. FOR Z Z1

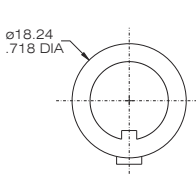

LOCK WASHER

STD.

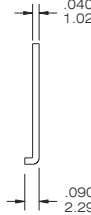

STD. FOR Z Z1

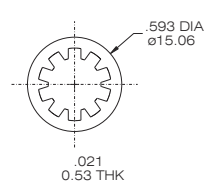
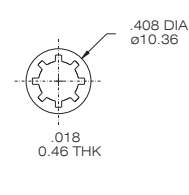

## The information of 3-way toggle switches

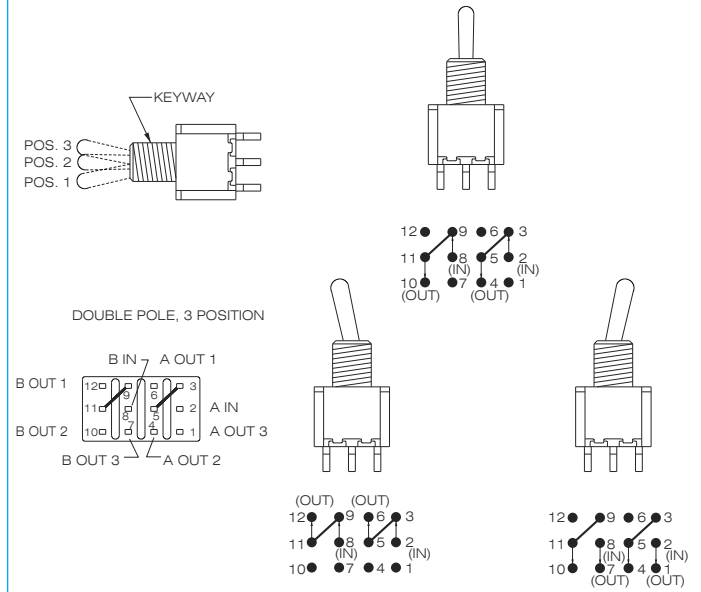
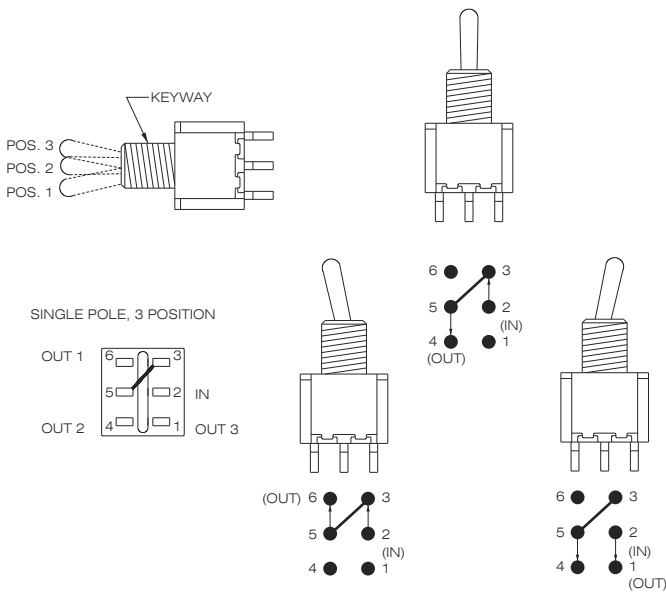

SP3T

DP3T