

ZCM Series Datasheet

SMD Precision Metal Film Resistors | MELF Style

ORDERING CODE - Example

New SAP Part Nr.:

ZCM	207	F	K	E	07-	1K	AA
Serie	Power rating	Tol.	Pack-Code	TCR	Forming type	R Value	Special
	102 = 0,2W 204 = 0,4W 207 = 1,0W	B = ±0,1% C = ±0,25% D = ±0,5% F = ±1% G = ±2% J = ±5% - = Jumper	K = Blister tape reel	C = ±15ppm D = ±25ppm E = ±50ppm F = ±100ppm - = Jumper	07- = 07 inch (Reel diameter) or 13- = 13 inch (Reel diameter)	OR = Jumper	AA = Standard

Historical VTM Part Nr.:

ZC	0207	F	K	E	07	1K
Type	Size	Tol.	K = Blister tape reel	TC	Reel diam.	R Value

APPLICATIONS

- Automotive
- Consumer & Electronics
- Power & Energy

FEATURES

- Precision MELF resistor
- Advanced MELF technology
- Excellent stability in different environmental conditions
- Best in class pulse load capability
- AEC – Q200 Qualified
- Intrinsic sulfur resistance
- RoHs & REACH Compliant

ELECTRICAL SPECIFICATIONS

Type		ZCM102	ZCM204	ZCM207
Historical Part Number	SMD	-	ZC0204	ZC0207
Nominal Power Rating P_{70}	[W]	0,2	0,4	1,0
Resistance Range (Other values upon request)	[Ω]	Min	10R	OR22
		Max	2M21	10M
E-Series		E24 / E96 / E192		
Tolerances	±[%]	B = 0,1%, F = 1%		B = 0,1%, C = 0,25%, D = 0,5%, F = 1%, G = 2%, J = 5%
Temperature Coefficient IEC60115-1 clause 4.2 ; 4.8 (+20 / -55[°C] and +20 / +125[°C])	±[10 ⁻⁶ K ⁻¹]	Depends on the value, please check the table below		
Working Temperature Range	[°C]	-55 ... +125	-55 ... +155	
Permissible film temperature (9F max.)	[°C]	125	155	
Max. Working Voltage	[AC or DC] _{RMS}	150	200	350
Dielectric Withstanding Voltage IEC115-1 clause 4.7 (1[min])	[V] _{RMS}	200	300	500

DIMENSIONS [mm]

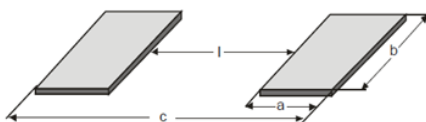
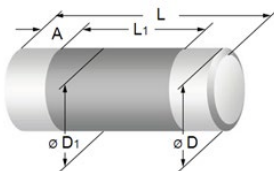

Type	Historical P/N:	L	∅ D	L ₁	∅ D ₁	A	MASS (mg)
ZCM102	-	2,2 ^{+0/-0,15}	1,1 ^{+0/-0,1}	1,2 min.	D ^{+0/-0,1}	0,40 ^{±0,05}	7
ZCM204	ZC0204	3,6 ^{+0/-0,2}	1,4 ^{+0/-0,1}	1,8 min.	D ^{+0/-0,15}	0,80 ^{±0,10}	22
ZCM207	ZC0207	5,8 ^{+0/-0,3}	2,2 ^{±0,2}	2,6 min.	D ^{+0/-0,2}	1,25 ^{±0,2}	77

Type	Recommended solder pads dimensions							
	Wave soldering				Reflow soldering			
	l	a	b	c	l	a	b	c
ZCM102	0,7	1,2	1,5	3,1	1,1	0,8	1,3	2,7
ZCM204	1,5	1,5	1,8	4,5	1,7	1,2	1,6	4,1
ZCM207	2,4	2,3	2,6	7,0	2,6	2,0	2,4	6,6

ZCM Series Datasheet

PERFORMANCE DATA

Type			ZCM102	ZCM204	ZCM207	
Historical Part Number			-	ZC0204	ZC0207	
Climatic Category			55/155/56			
Short Time Overload IEC60115-1 clause 4.13 ($U=2,5 \cdot \sqrt{P_{70} \times R}$, $\leq 2 \cdot U_{max}$, 5 [s])	Standard operation	±[%]	0,1 (<211kΩ) ; 0,15(>211kΩ)	0,03 (≤1M) ; 0,15 (>1M)	0,03 (≤1M) ; 0,15 (>1M)	
	Power operation		-	0,05 (≤1M) ; 0,15 (>1M)	0,05 (≤1M) ; 0,15 (>1M)	
Single pulse high voltage overload IEC60115-1 clause 4.27 ($U=10^*$, Severity 4, 10 pulses 10[μs]/700[μs])	Standard operation	±[%]	-	0,15	0,25	
	Power operation		-	0,15	0,5	
Periodic electric overload IEC60115-1 clause 4.39 ($U=15 \cdot \sqrt{P_{70} \times R}$, 0,1[s]on, 2,5[s]off, 1000 cycles)	Standard operation	±[%]	-	0,15	0,15	
	Power operation		-	0,3	0,3	
Failure Rate (Total, 90 , max, 60[%] cont. lev.)		$[10^{-9} h^{-1}]$	≤ 0,1			
Endurance at 70°C, IEC60115-1 clause 4.25 $1,5 \times R$ ($U=U_{max}$, 1,5[h]ON ; 0,5[h]OFF)	Precision operation	±[%]	1000h	-	0,05 (10R≤1M)	0,05 (10R≤1M)
			8000h	-	0,1 (10R≤1M)	0,1 (10R≤1M)
	Standard operation	±[%]	1000h	0,25 (<211kΩ) ; 0,5(>211kΩ)	0,15 (<10R) ; 0,1 (10R≤1M) ; 0,25	0,15 (≤1M) ; 0,5 (>1M)
			8000h	0,5 (<211kΩ) ; 1 (>211kΩ)	0,3 (<10R) ; 0,2 (10R≤1M) ; 0,5	0,3 (≤1M) ; 1 (>1M)
Power operation	±[%]	1000h	-	0,25	0,25 (≤1M) ; 0,5 (>1M)	
		8000h	-	0,5	0,5 (≤1M) ; 1 (>1M)	
Endurance at upper Category Temp. IEC60115-1 clause 4.25.3 (1000[h])	±[%]	125°C	0,25 (<211kΩ) ; 1 (>211kΩ)	0,15 (≤1M) ; 0,5 (>1M)	0,15 (<10R) ; 0,1 (10R≤1M) ; 0,25 (>1M)	
		155°C	-	0,3 (≤1M) ; 1 (>1M)	0,3 (<10R) ; 0,2 (10R≤1M) ; 0,5 (>1M)	
Damp Heat, Steady State IEC60115-1 clause 4.24 (40 ⁺² [°C], 93 ⁺² [% r.h.], 56[d])	±[%]		0,5 (<211kΩ) ; 1 (>211kΩ)	0,25 (≤ 1M) ; 1 (>1M)	0,25 (≤ 1M) ; 1 (>1M)	
Damp Heat, Steady State, Accelerated IEC60115-1 clause 4.37 (85 ⁺² [°C], 85 ⁺⁵ [%RH], $U = 0,3 \cdot \sqrt{P_{70} \times R}$)	±[%]		-	0,25 (≤ 1M) ; 2 (>1M)	0,5 (≤ 1M) ; 2 (>1M)	
Temperature Cycling IEC60068-2-14 ; IEC60115-1 clause 4.19 (30[min] each , 1000 cycles)	±[%]	-55~125°C	-	0,25	0,25	
		-55~155°C	-	0,5	0,5	
Vibration IEC60068-2-6 ; IEC60115-1 clause 4.22 (10;2000[Hz], ≤1,5[mm] , or ≤200[m/s ²] 7,5[h])	±[%]		-	0,05 (≤ 1M) ; 0,1 (>1M)	0,05	
Resistance to Soldering Heat IEC60115-1 clause 4.18 (260 ⁺⁵ [°C], 10 ⁺¹ [s])Solder bath method	±[%]		0,1 (<211kΩ) ; 0,25(>211kΩ)	0,1 (≤ 10R) ; 0,05 (>10R)	0,1 (≤ 10R) ; 0,05 (>10R)	
Electrostatic Discharge IEC60115-1 clause 4.38 ; IEC61340-3-1 (3 positives + 3 negatives discharges)	±[%]		-	0,5 [2 kV]	0,5 [4 kV]	
Voltage proof IEC60115-1 clause 4.7 $U_{RMS}=U_{INS}$, 60 [s]			-	No flash over or breakdown		
Flammability IEC60115-1 clause 4.35, IEC60695-11-5 Needle flame test, 10[s]			-	No burning after 30[s]		
Solderability IEC60068-2-20 ; IEC60115-1 clause 4.17 (235 ⁺³ [°C] 2 ^{+0,2} [s], SnAg ₃ Cu _{0,5} or SnAg _{3,5})			-	≥ 95% covered, no visible damage		

ZCM Series Datasheet

Component Resistance to Solvents <i>IEC60068-2-45 ; IEC60115-1 clause 4.29 (50[°C] method 2)</i>		No visible damage
Resistance to solvents of Marking <i>IEC60068-2-45 ; IEC60115-1 clause 4.30 (50[°C] method 1)</i>		Marking visible , no visible damage
Marking <i>IEC60062</i>		Color code

NOTES: MARKING [COLOR CODE]:

- **ZCM204** Color code marking is applied according to IEC 60062 in four bands (E24 series) for 5 % tolerance, or in five bands (E96 or E192 series). Each color band appears as a single solid line, voids are permissible if at least $\frac{2}{3}$ of the band is visible from each radial angle of view. The last color band for tolerance is approximately 50 % wider than the other bands.
 - **ZCM207** Color code marking is applied according to IEC 60062 in four (E24 series) or six bands (E96 series). Each color band appears as a single solid line, voids are permissible if at least $\frac{2}{3}$ of the band is visible from each radial angle of view. The last color band represents the TCR for resistors with TCR ≤ 50 ppm/K and nominal tolerance ≤ 1 %.
- Zero ohm jumpers** are marked with one centered black band.

TEMPERATURE COEFFICIENT

ZCM102	ZCM204	ZCM207			
Resistance range			Tolerance	TCR	E-Series
-	OR22 ... OR91	OR16 ... OR91	$\pm 5\%$	± 100 ppm/K	E24
-		OR22 ... OR91	$\pm 2\%$		
10R...2M21	OR82... 10M	1R... 10M	$\pm 1\%$	± 50 ppm/K	E24 / E96
-	10R... 1M65	1R... 2M21	$\pm 0,5\%$		E24 / E192
-	10R... 1M65	43R... 1M	$\pm 0,5\%$		± 25 ppm/K
-	22R... 1M65	43R... 1M	$\pm 0,25\%$		
100R... 100K	22R... 1M65	43R... 1M	$\pm 0,1\%$		
-	10R... 221K	100R... 511K	$\pm 0,5\%$	± 15 ppm/K	
-	22R... 221K	100R... 511K	$\pm 0,25\%$		
100R... 100K	43R... 221K	100R... 511K	$\pm 0,1\%$		
Jumper $I_{max} = 2A$	Jumper $I_{max} = 3A$	Jumper $I_{max} = 5A$	≤ 10 m Ω		

The body coating color is light green for jumpers and for a temperature coefficient of ± 50 or 100 [ppm], pink for ± 25 [ppm] and violet for ± 15 [ppm]

MAXIMUM RESISTANCE CHANGE AT RATED DISSIPATION

OPERATION MODE	ZCM102		ZCM204		ZCM207			
	STANDARD	PRECISION	STANDARD	POWER	PRECISION	STANDARD	POWER	
Rated Power dissipation P_{70} [W]	0,2	0,07	0,25	0,4	0,125	0,4	1,0	
Operating temp. range [°C]	-55 to 125	-10 to 85	-55 to 125	-55 to 155	-10 to 85	-55 to 125	-55 to 155	
Permissible film temperature ϑF Max [°C]	125	85	125	155	85	125	155	
Resistance range	10R – 2M21	10R – 1M	R22 – 1M	R22 – 10M	100R – 511K	1R0 – 1M	1R0 – 1M	
Max. Resistance drift [%] [$\Delta R/R$]	1000h	$\leq 0,5$	$\leq 0,05$	$\leq 0,15$	$\leq 0,25$	$\leq 0,05$	$\leq 0,15$	$\leq 0,25$
	8000h	≤ 1	$\leq 0,1$	$\leq 0,3$	$\leq 0,5$	$\leq 0,1$	$\leq 0,3$	$\leq 0,5$
	225 000h	-	$\leq 0,25$	$\leq 0,75$	-	$\leq 0,25$	$\leq 1,0$	-

A suitable low thermal resistance of the circuit board assembly must be safeguarded in order to maintain the film temperature of the resistors within the specified limits.

ZCM Series Datasheet

PERFORMANCE GRAPHS

Derating – Precision Operation

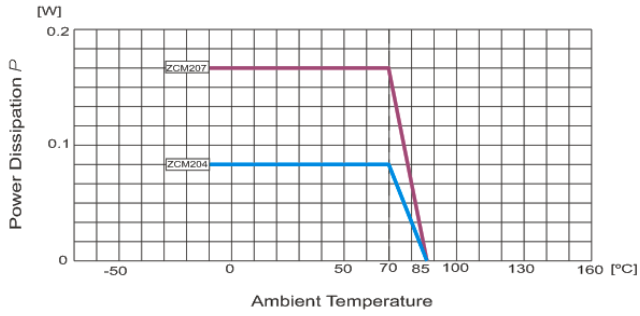

Derating – Standard Operation

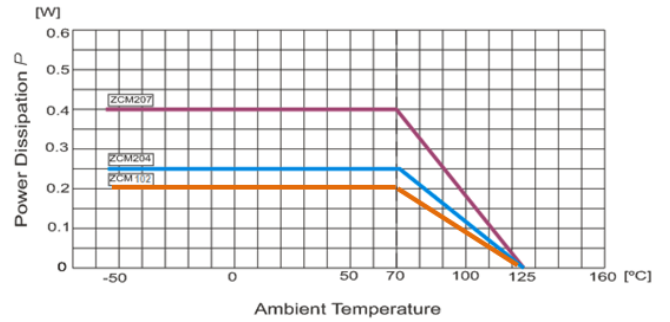

Derating – Power Operation

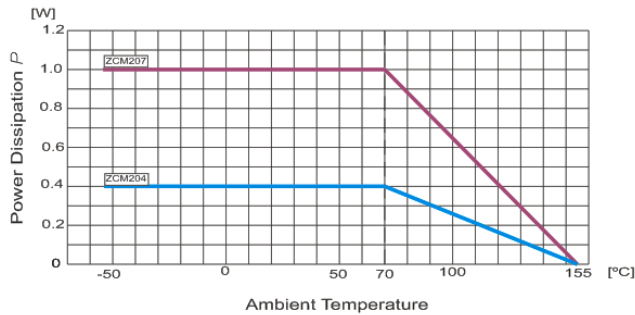

Non-Linearity

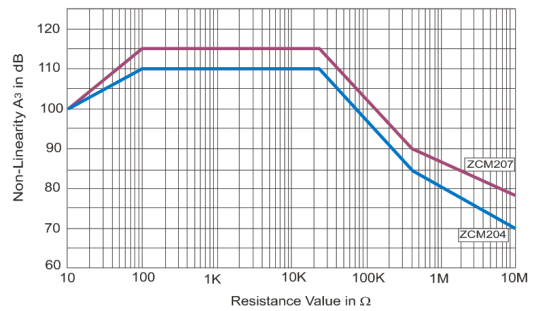

Current Noise

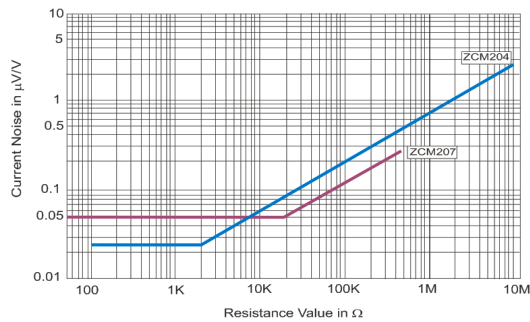

Pulse Voltage

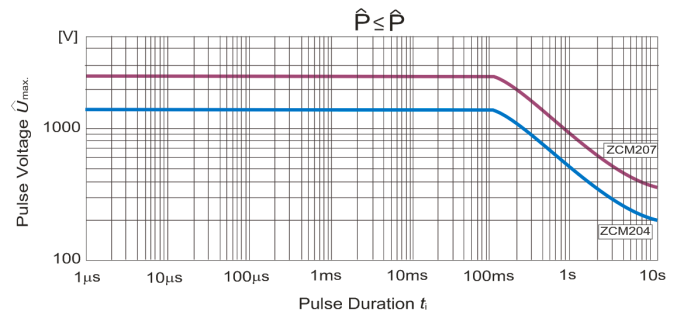

ZCM Series Datasheet

Single Pulse for $R < 10\Omega$

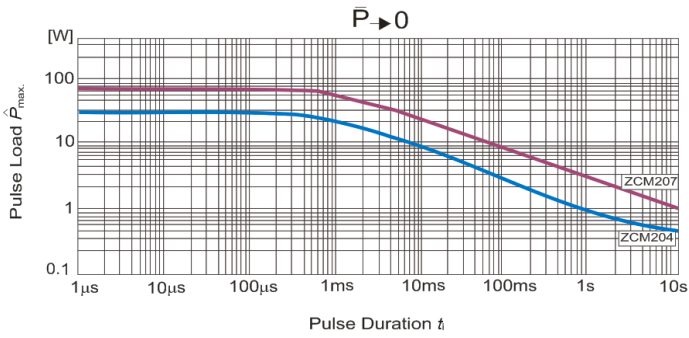

Continuous Pulse for $R < 10\Omega$

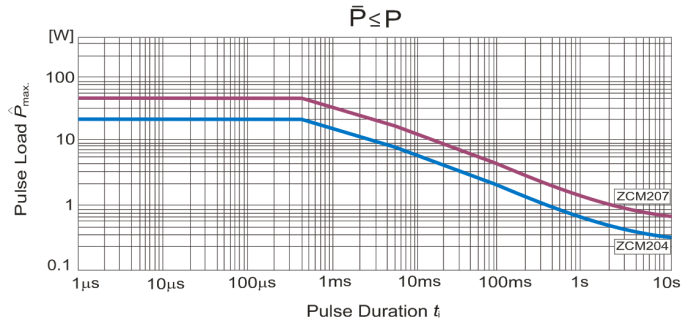

Single Pulse for $R \geq 10\Omega$

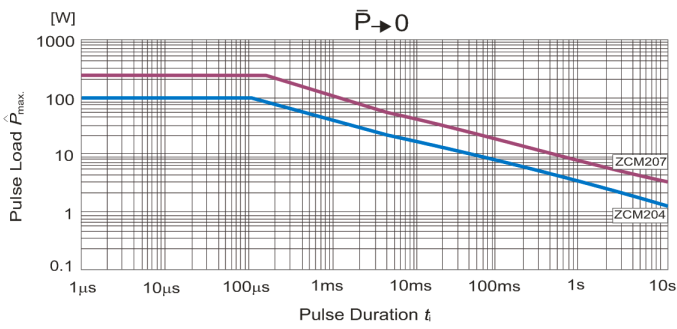

Continuous Pulse for $R \geq 10\Omega$

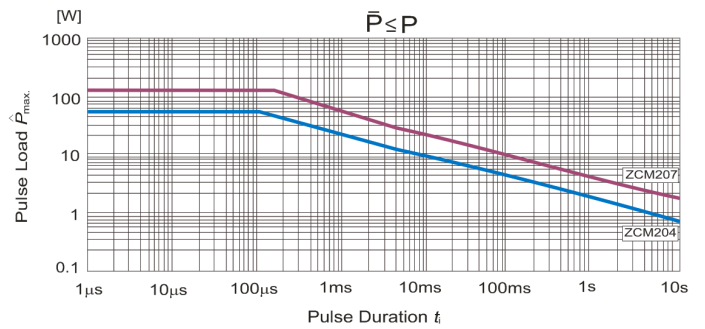

Single Pulse (1.2/50 [μs])

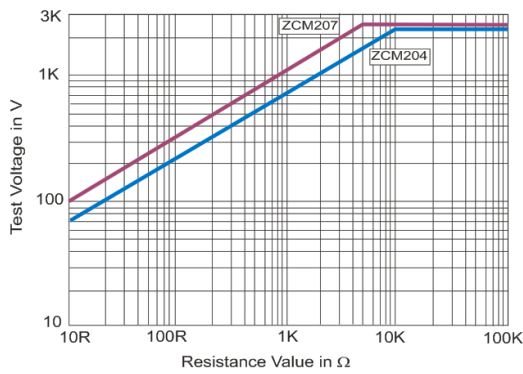

Single Pulse (10/700 [μs])

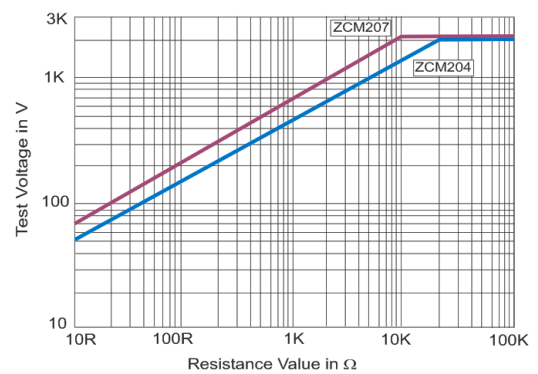

ZCM Series Datasheet

PACKAGING

The type ZCM is packed in antistatic blister tape according to IEC60286-3, type 2a, packing details described below.

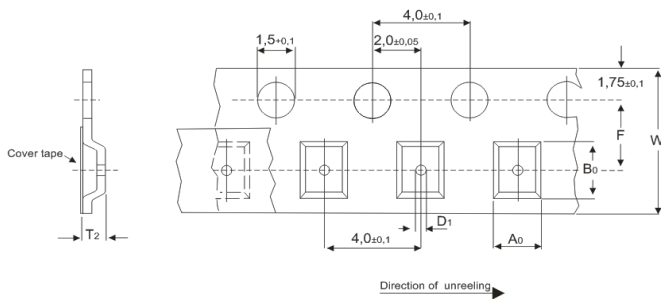
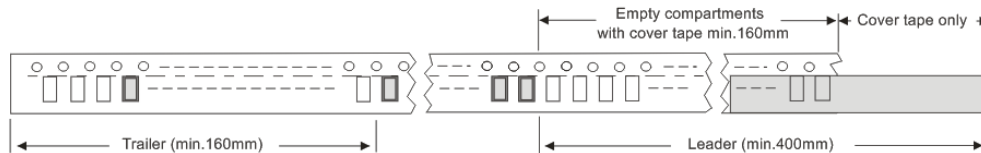

Type	A0	B0	F	W	D1	T2
ZCM102	1,3±0,1	2,47±0,1	3,5±0,05	8,0±0,3/-0,1	1,0	≤ 1,65
ZCM204	1,55±0,1	3,7±0,1	3,5±0,05	8,0±0,3	1,0	≤ 1,8
ZCM207	2,40±0,1	6,0±0,1	5,5±0,05	12,0±0,3	1,5	≤ 2,7

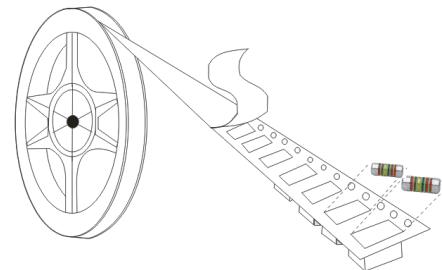
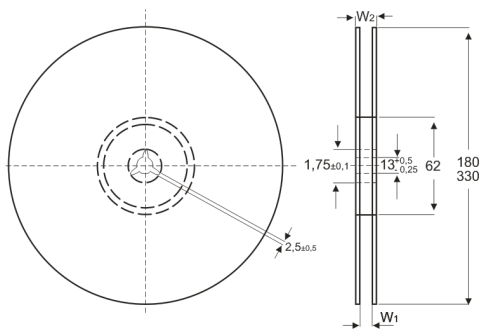

Type	W1 [±1,5]	W2 [max]
ZCM102	8,4 ^{+1,5/-0}	14,4
ZCM204	8,4	14,4
ZCM207	12,4	18,4

Type	Packaging [dimensions]	Quantity [pcs]
ZCM102	07(inch) Blister tape	3000
ZCM204		3000
ZCM207		1500
ZCM204	13(inch) Blister tape	10000
ZCM207		7500